

# MANUFACTURING RESEARCH&DEVELOPING

CATALOGUE 67\_EN 2025

 **MICROTECH**

est. 1995

**U K R A I N E**

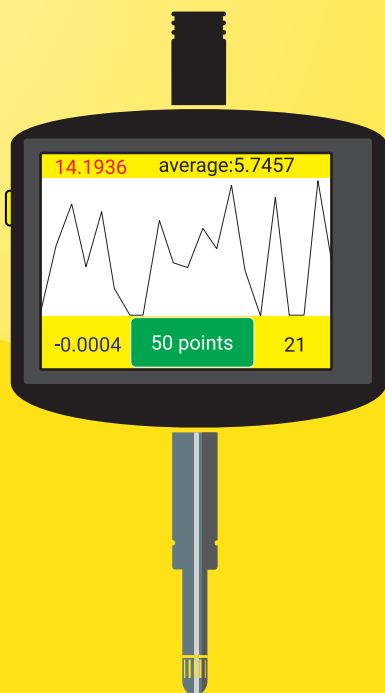
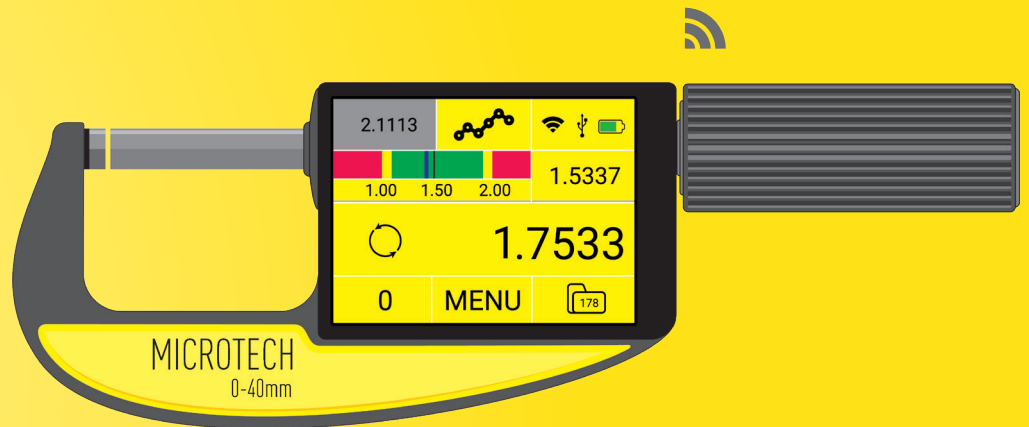

# ONLY INNOVATIVE MEASURING INSTRUMENTS

# WHAT IS MICROTECH

**INDUSTRY 4.0**  
INSTRUMENTS

**130+**  
**PATENTS**  
DEVELOPED

**50+**  
**DISTRIBUTORS**  
WORLDWIDE



**ISO9001:2015**



**ISO17025:2017**

**CE, ROHS**  
CERTIFICATION

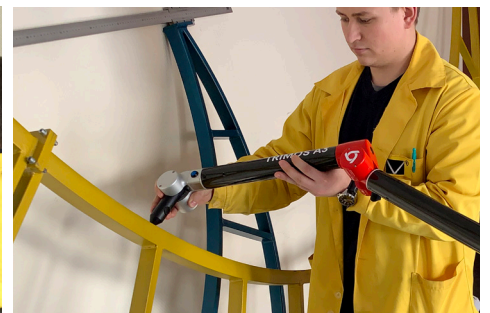
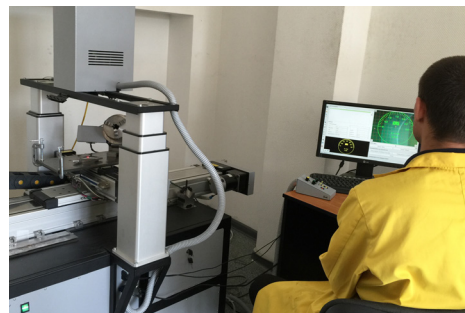

**MANUFACTURING DEPARTMENTS IN KYIV AND KHARKIV (UKRAINE)**

# MICROTECH INNOVATIONS

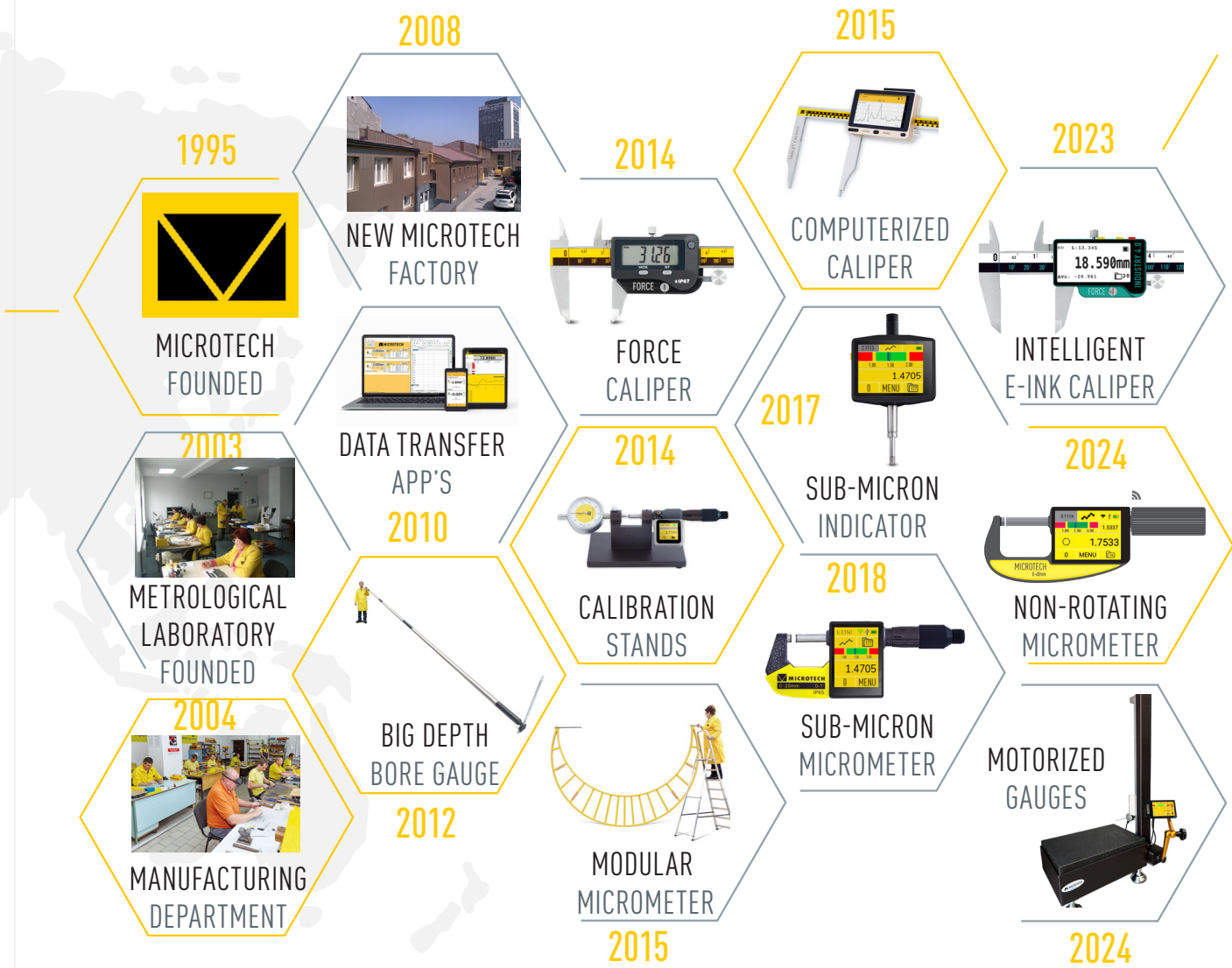

ISO17025:2017 ACCREDITED METROLOGY LABORATORY



8

DATA TRANSMISSION & SOFTWARE



62

DEPTH CALIPERS

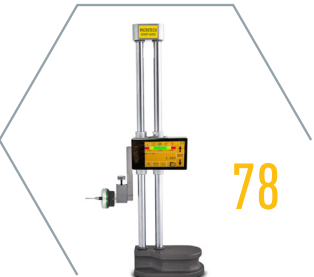

78

MANUAL & MOTORIZED HEIGHT GAUGES



118

SNAP GAUGE



132

DIAL GAGE STANDS



142

CALIPER GAUGES

CALIPERS

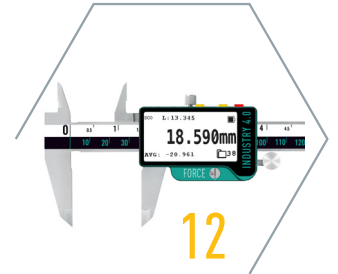

12

SCALES

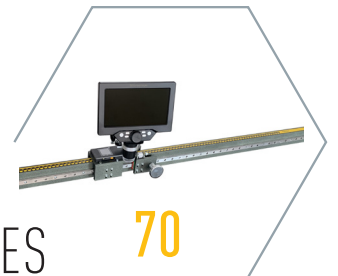

70

MICROMETERS



84

INDICATORS



122

THICKNESS GAUGES



134



## INTERNAL MICROMETER

## PISTOL GRIP BORE GAUGES



## BORE GAUGES

## RADIUS GAUGES

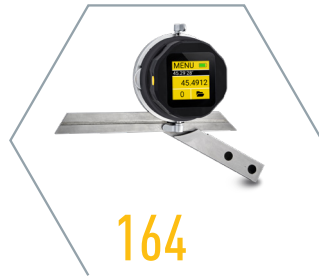

## PROTRACTORS

## LEVELS

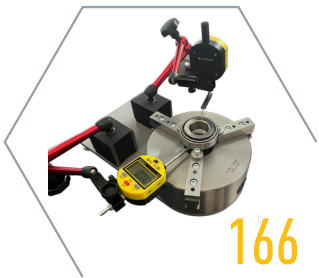
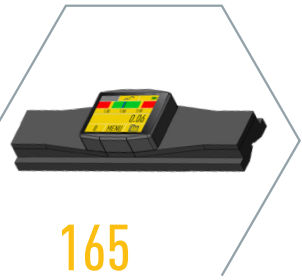

## MEASURING STANDS

## CALIBRATION EQUIPMENT

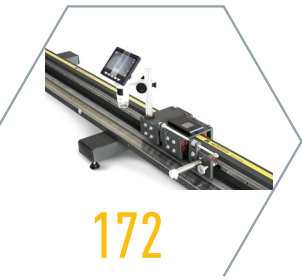

## PORTABLE HARDNESS TESTERS

## FORCE TESTERS AND STANDS



## WIRELESS INSTRUMENTS



### 3 DATA TRANSFER MODES:

- WIRELESS data to MDS app (Windows, Android, MacOS, iOS)
- WIRELESS HID to any app and OS
- WIRELESS HID+MAC to any app and OS (with MAC address)

## E-INK INSTRUMENTS

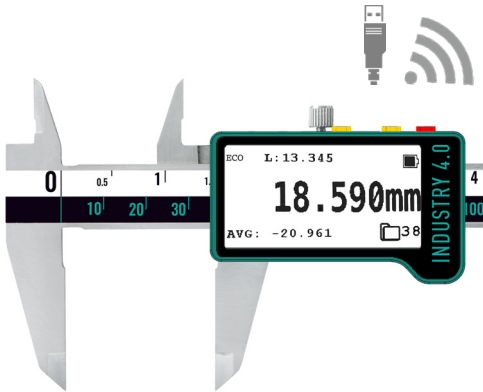

### 4 DATA TRANSFER MODES:

- WIRELESS data to MDS app (Windows, Android, MacOS, iOS)
- WIRELESS HID to any app and OS (DOT/COMMA; SYMBOLS config)
- WIRELESS HID+MAC to any app and OS (with MAC address)
- USB HID to any app and OS (dot/comma/symbols config)

**EXTRA FUNCTIONS:** DATA TRANSFER from MEMORY, by TIMER

## COMPUTERIZED INSTRUMENTS



### 5 DATA TRANSFER MODES:

- WIRELESS data to MDS app (Windows, Android, MacOS, iOS)
- WIRELESS HID to any app and OS (dot/comma/symbols config)
- WIRELESS HID+MAC to any app and OS (with MAC address)
- USB HID to any app and OS (dot/comma/symbols config)
- HUB (2D, Probe) synchronization (Slave device)

**EXTRA FUNCTIONS:** DATA TRANSFER from MEMORY, FOLDERS, TIMER

## TABLET INSTRUMENTS



### 6 DATA TRANSFER MODES:

- WIRELESS data to MDS app (Windows, Android, MacOS, iOS)
- WIRELESS HID to any app and OS (dot/comma/symbols config)
- WIRELESS HID+MAC to any app and OS (with MAC address)
- USB HID to any app and OS (dot/comma/symbols config)
- HUB (2D, Probe)synchronization (Slave device)
- HUB (2D, Probe) synchronization (Master device)

**EXTRA FUNCTIONS:** DATA TRANSFER from MEMORY, FOLDERS, GRAPHIC, SYNCHRONIZED DEVICE, TIMER

# MICROTECH INSTRUMENTS FUNCTIONS



TABLET

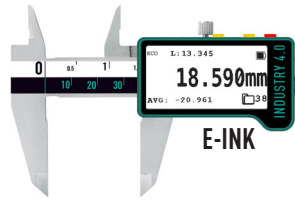

E-INK



DIGITAL USB

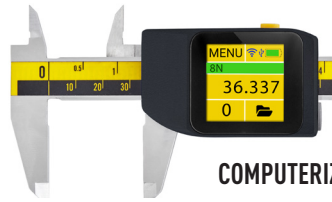

COMPUTERIZED



DIGITAL WIRELESS

Functions	COMPUTERIZED				DIGITAL	
	TABLET LAB	TABLET	COMPUTERIZED	E-ink	WIRELESS	USB
Display	Color 3,5"	Color 2,4"	Color 1,54"	Mono 2,13"	Digital	
Resolution	480x320	320x240	240x240	250x122		
Touchscreen	•	•	•	•		
Charging socket	Micro-USB IP67					
Rechargeable battery	•	•	•	•		
Battery status	•	•	•	•		
Energy saving modes	•	•	•	•	•	•
Auto sleep on	•	•	•	•	•	•
Memory	val.	50000	2000	2000	1000	
	Folders	•	•	•		
	Statistics	•	•	•	•	
	Data transfer	•	•	•	•	
Connection	Wireless	Long range to MDS app for Windows, Android, iOS, MacOS (Free & Pro version)				
	Wireless HID	HID connection direct to any app and OS (like keyboard) with format config				
	Wireless HID+MAC	HID connection direct to any app and OS (like keyboard) with MAC address				
	USB HID	HID USB connection direct to any app and OS (like keyboard) with format config				HID USB
HUB mode	Modbus/PLC	option	option			
	2D master	Wireless Sync like Master				
	2D slave	Wireless Sync like Slave device				
3D Probes operating	Probe mode	Wireless Sync with ext Probes				
	Manual mode	•				
	Auto mode	•				
Geometric measuring	•					
Motor-driven operation	option					
External joystick	option					
Connection status	•	•	•	•		
Preset	Preset manager with quick activating				•	option
Adjustable Analog scale	•	•				
Formula	•	•	•	•		
Limits (Go/NoGo)	•	•	•	•		
Peak (Min/Max)	•	•	•	•		
Last value (HOLD)	•	•	•	•		option
Resolution selection	•	•	•	•		
mm/inch selection	•	•	•	•	•	•
Formula	•	•	•	•		
Linear correction	•	•	•	•		
Temperature correction	•	•	•	•		
Timer	•	•	•	•		
Calibration date	•	•	•	•		
Password manager	•	•	•			
User manager	•					
Firmware update	•	•	•	•		

	MDS for iOS	MDS for Android
	<b>FREE</b>	<b>FREE</b>
	299100060	299100040
Platform	iOS, MacOS (M1+)	Android 6,0 +
Max. instruments	8	8
mm/inch conversion	•	•
Go/NoGo functions	•	•
Graphical mode	•	•
Reading on Timer	•	•
Measuring history	•	•
Save data to xls	•	•
Save data to csv	•	•
Save graph	•	•
User manager	•	•
Device battery status indication	•	•
Voice mode	•	•
Multilanguage	3 language	12 languages



MDS APP FOR WINDOWS

- **FREE** version can be downloaded/ **STANDARD & PRO** versions supplying on USB-stick
- **Functions:** Go/NoGo, Timer, Linear correction, Statistics mode, Data Export, Graphic
- **USB-DONGLE REQUESTED**

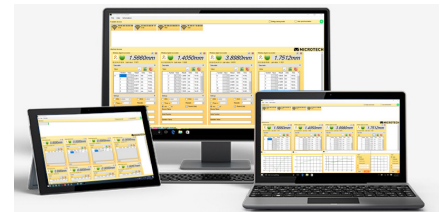

MDS app for Windows			
	FREE	STANDARD	PRO
	299100530	299100550	299100570
Platform	Windows 7, 8, 10, 11		
Max. instruments	1	4	32
USB-dongles (max qty)	1	1	8
Standard/Energy saving mode	•	•	•
Autoconnection	•	•	•
Filtering MICROTECH devices	•	•	•
Data reading Synchronizing	•	•	•
User manager	•	•	•
Foot-Switch connection	•	•	•
mm/inch conversion	•	•	•
Go/NoGo functions	•	•	•
Graphical mode	•	•	•
2D-Graphical mode	•	•	•
Timer	•	•	•
Resolution selection	•	•	•
Export to external programs	•	•	•
Save data to csv, xls, pdf	•	•	•
Save graph png	•	•	•
Multilanguage	10 languages		

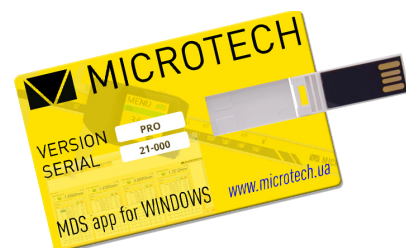
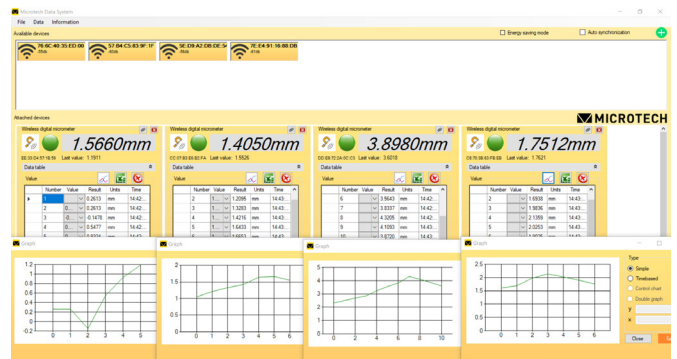



# ACCESSORIES FOR MDS APP

Item No	Type
299100550	MDS 5.0 <b>STANDARD</b> app for Windows
299100570	MDS 5.0 <b>PRO</b> app for Windows
299190001	USB-Dongle for Windows (max 3 connect)
299190002	USB-Dongle for Windows (max 8 connect)
299190004	1m Cable extension for USB-Dongle
299190005	1m USB hub (4-ports) for USB-Dongles
299190000	USB-Footswitch for Windows
29990011	IoT data button (Instruments only)
29990012	IoT data button (Instruments/MDS)
29990013	IoT data button+Footswitch (Instruments/MDS)



299100550



299190001



29990013



299190004

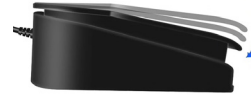

299190000

## CONNECTION SET FOR WINDOWS

### STANDARD MDS data set



STANDARD MDS app

SET for 3 instruments Wireless connection

### PRO MDS data set



PRO MDS app

SET for 6 instruments Wireless connection

### PRO+ MDS data set



PRO MDS app

SET for 12 instruments Wireless connection

Item No	Type	ACCESSORIES in SET			Recommended connected devices
		Application	USB-dongles	Cable-Extensions	
299110504	STANDARD MDS data set	MDS 5.1 <b>STANDARD</b> app for Windows	1	1	3
299110810	<b>PRO</b> MDS data set	MDS 5.1 <b>PRO</b> app for Windows	2	2	6
299110840	<b>PRO+</b> MDS data set	Windows	4	4	12

## USB DATA CABLE FOR DIGITAL INSTRUMENTS

INPUT



OUTPUT

DIRECT TO EXCELL OR ANY OTHER APP



Item No	Type	Devices
141083000	USB HID DATA TRANSFER CABLE 2.5M DIRECT DATA TRANSFER, LIKE A KEYBOARD	Digital calipers IP54 Digital indicators IP65

- IoT Display units
- CONNECTION with MICROTECH instruments
- Functions: Go/NoGo, Timer, Linear correction, Statistics mode, Data Export, Graphic
- Modification with Built-in rechargeable Li-Pol battery
- CUSTOM FUNCTIONS FOR REQUEST

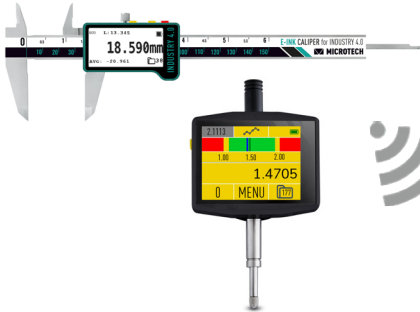

299999001 IOT MDS PRO



INPUT-OUTPUT



SAVING DATA TO XLS, CSV FORMATS



SAVING GRAPH



RJ-45

IoT MDS CONNECT DISPLAY UNITS			
		IP67	PRO
Type		IP67	PRO
Item No		299999003	299999001
Touchscreen Display		10" (1280x800)	11,6" (1920x1080)
Protection		IP67	
Platform		Windows 10 / MDS 5.1 PRO	
INPUT CONNECTION	USB-DONGLES	1 (max 2)	1 (max 8)*
	WIRELESS	8 (max16)	8 (max 32)
	WIRELESS HID	8	8
	USB HID	2	4 (max64)*
DATA OUTPUT & EXPORT	WIRELESS & USB HID		
	MODBUS		
	WI-FI	•	•
	USB port	2+1	4
	RJ-45	•	•
	RS-232	1	3
	RS-485		1
	Cardreader	•	•
FUNCTIONS	HDMI	•	•
	Autoconnection	•	•
	Reading Synchronizing	•	•
	User manager	•	•
	Foot-Switch connection	•	•
	mm/inch conversion	•	•
	Go/NoGo functions	•	•
	Graphical mode	•	•
	2D-Graphical mode	•	•
	Timer	•	•
	Resolution selection	•	•
	Resend to external app's	•	•
	Save data to csv, xls, pdf	•	•
	Save graph png	•	•
	*xls, *csv, *doc file editor	•	•
	App's installation	•	•
	ACCESSORIES	Multilanguage	10 languages
USB-DONGLES		1 (optional 8)	
USB-Footswitch		option	option
	Wireless-Footswitch	option	option
	Rechargeable Built in Li-Pol battery	8000mAh	-
	Dimensions, mm	280×184×26	283 x 177 x 73
	Weight, kg	1,15	1,25



OPTIONAL ACCESSORIES

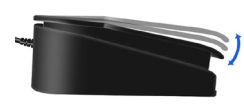

- IoT multifunction DATA button
- CONNECTION with MICROTECH instruments / MDS app for WINDOWS
- Modification with External FOOTSWITCH connection
- Built-in rechargeable Li-Pol battery
- CUSTOM FUNCTIONS FOR REQUEST

29990011

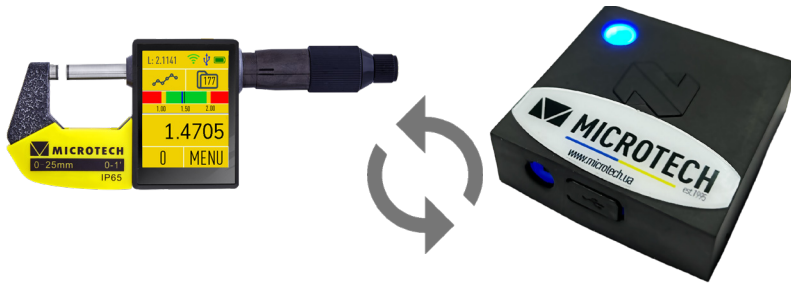

29990012



29990013



IoT DATA BUTTON				
	Item No	29990011	29990012	29990013
DATA OUTPUT	WIRELESS	•	•	•
CONNECTING	Reading Synchronizing	•	•	•
	Save data in MDS app	•	•	•
WINDOWS	LED status indication	•	•	•
External FOOTSWICH				•
FUNCTIONS	Autoconnection	•	•	•
	Reading Synchronizing	•	•	•
	Save data to internal memory	•	•	•
	Timer activation	•	•	•
	LED status indication	•	•	•
	Rechargeable Built in Li-Pol battery	500 mAh	500 mAh	500 mAh
	Dimensions, mm	60x60x20	60x60x20	60x60x20
	Weight, kg	0,2	0,2	0,2

## OPTIONAL ACCESSORIES



**IoT MDS CONNECT DISPLAY UNIT**  
USB, WI-FI, RJ-45, RS-485, LoRa OUTPUT

- Industry 4.0 adopted E-Force caliper with computerized MICS system (Patents US10184772, UA174949, UA126928)
- **SWISS made reading system** Min resolution **0.001mm** (0,001/0,01/0,1mm selection)
- 2.0 inch color Touchscreen display (320x240 resolution)
- **Functions:** Go/NoGo, Max/Min, Formula, Timer, Linear correction, Temperature correction, Resolution select, Connection indication
- **Memory manager:** 2000 values, Folders system, Statistics mode, Memory data transfer
- **Graphical mode**
- E-Force control module with Force selection 1-20N, color indication, AUTO-Force mode, Force indication
- **Measuring HUB:** Wireless MICROTECH instrument connection, Synchronization, 2D mode, 2D Graph, Probe mode, Compensation
- **4 MODES DATA TRANSFER:** WIRELESS to MDS app (Windows, Android, iOS, MacOS); WIRELESS HID, WIRELESS HID+MAC, USB HID
- Top quality Aluminium housing (CNC machined solid block)
- **Calibration** certificate included (ISO17025 (Ilac MRA))

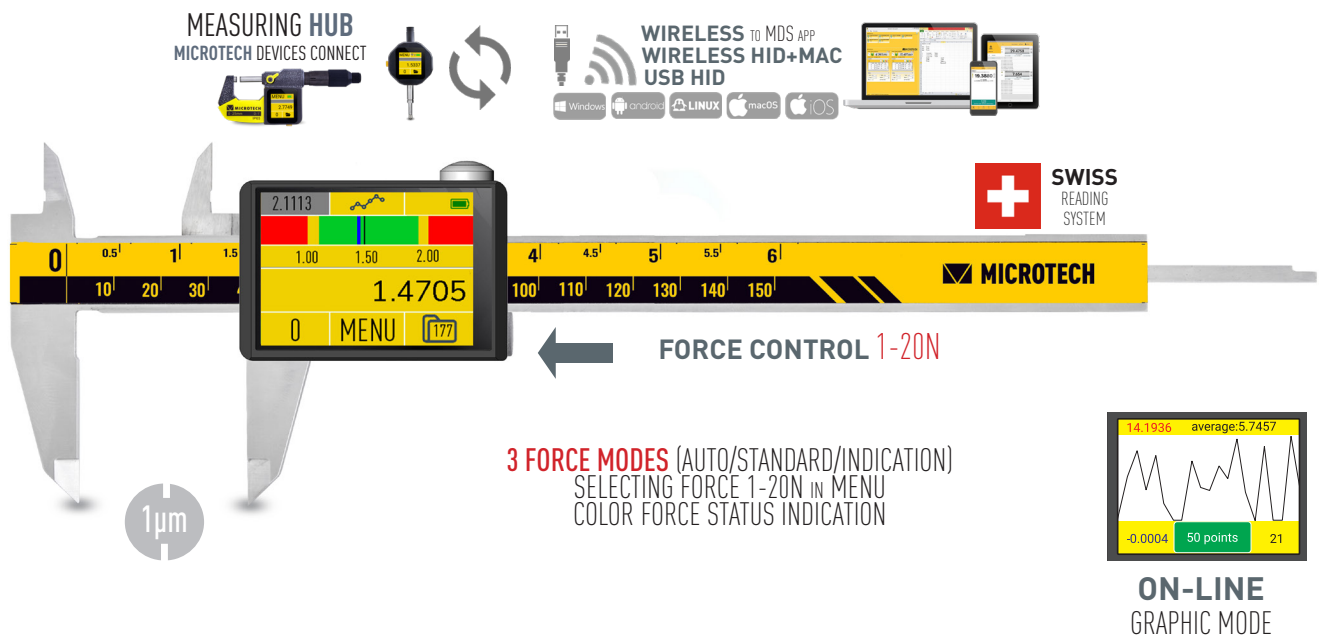

Item No	Range		Reso- lution	Accu- racy*	eForce	Jaws	Measuring HUB	Analog scale	Graphic	Preset	Go/NoGo	Max/Min	Formula	Timer	Temp comp	Linear corr.	Calibr date	Recharge	Auto off	Password	Memory	Statistics	WIRELESS	USB HID	FW update		
	mm	inch																								mm	µm
141088015A	0-150	0-6"	0,001	±5	1-20	40/16	•	•	•	•	•	•	•	•	•	•	•	•	•	•	1000 val	•	•	•	•		
141088020A	0-200	0-8"		±8		50/17	•	•	•	•	•	•	•	•	•	•	•	•	•	•		•	•	•	•	•	•
141088030A	0-300	0-12"		±10		60/20	•	•	•	•	•	•	•	•	•	•	•	•	•	•		•	•	•	•	•	•

OPTIONAL ACCESSORIES

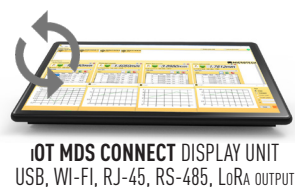

DOWNLOAD APP



\*Accuracy on external jaws. Internal jaws and Depth according ISO13385-1

- Industry 4.0 adopted E-Force caliper with computerized MICS system (Patents US10184772, UA174949, UA126928)
- Min Resolution 0.005mm (0,01/0,1mm selection)
- Functions: Go/NoGo, Max/Min, Formula, Timer, Linear correction, Temperature correction, Resolution select, Connection indication
- Memory manager: 2000 values, Folders system, Statistics mode, Memory data transfer
- E-Force control module with Force selection 1-20N, color indication, AUTO-Force mode, Force indication
- **4 MODES DATA TRANSFER:** WIRELESS to MDS app (Windows, Android, iOS, MacOS); WIRELESS HID, WIRELESS HID+MAC, USB HID
- Calibration certificate included (ISO17025 (Ilac MRA))

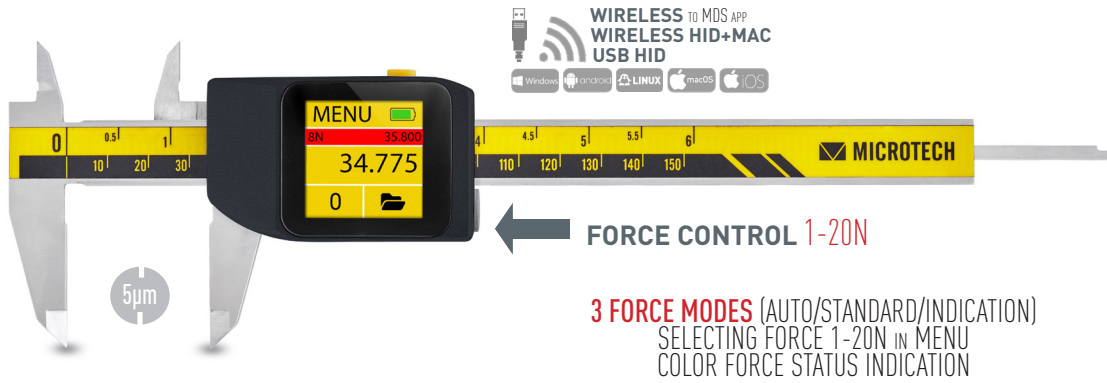

**3 FORCE MODES** (AUTO/STANDARD/INDICATION)  
 SELECTING FORCE 1-20N IN MENU  
 COLOR FORCE STATUS INDICATION

Item No	Range		Reso- lution	Accu- racy*	eForce	Jaws	Preset	Go/NoGo	Max/Min	Formula	Timer	Temp comp	Linear corr.	Calibr date	Recharge	Auto off	Password	Memory	Statistics	WIRELESS	USB HID	
	mm	inch																				mm
141077015A	0-150	0-6"	0,005	±10	1-20	40/16	•	•	•	•	•	•	•	•	•	•	•	1000 val	•	•	•	
141077020A	0-200	0-8"		±10		50/17	•	•	•	•	•	•	•	•	•	•	•		•	•	•	•
141077030A	0-300	0-12"		±15		60/20	•	•	•	•	•	•	•	•	•	•	•		•	•	•	•

## COMPUTERIZED E-FORCE CALIPER CARBIDE JAWS

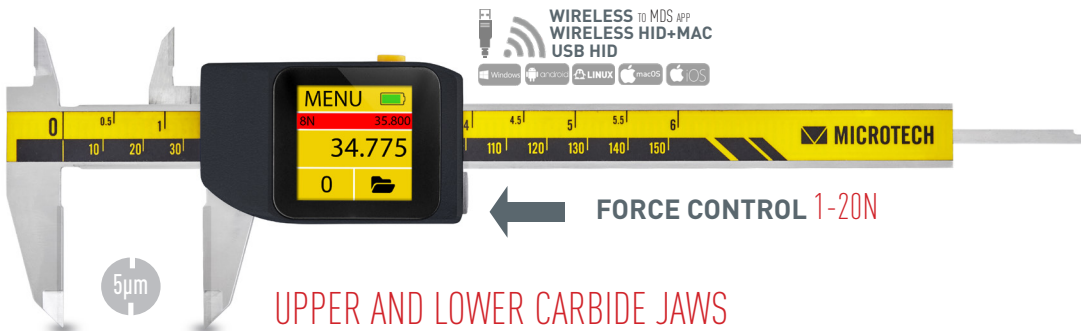

UPPER AND LOWER CARBIDE JAWS

Item No	Range		Reso- lution	Accu- racy*	eForce	Jaws	CARBIDE	Preset	Go/NoGo	Max/Min	Formula	Timer	Temp comp	Linear corr.	Calibr date	Recharge	Auto off	Password	Memory	Statistics	WIRELESS	USB HID
	mm	inch																				
141077015C	0-150	0-6"	0,005	±10	1-20	40/16	•	•	•	•	•	•	•	•	•	•	•	1000 val	•	•	•	
141077020C	0-200	0-8"		±10		50/17	•	•	•	•	•	•	•	•	•	•	•		•	•	•	
141077030C	0-300	0-12"		±15		60/20	•	•	•	•	•	•	•	•	•	•	•		•	•	•	

### OPTIONAL ACCESSORIES

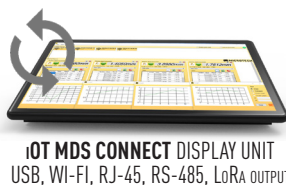

### DOWNLOAD APP



\*Accuracy on external jaws. Internal jaws and Depth according ISO13385-1

- **Industry 4.0** adopted Intelligent caliper with computerized MICS system (Patents US10184772, UA174949, UA126928)
- **ENERGY ECONOMY** 2.13" E-ink display (200+ working hours / 1 charging)
- **Functions:** Go/NoGo, Max/Min, Formula, Timer, Linear correction, Resolution selecting, Connection indication
- **Memory manager:** 1000 values, Statistics mode, Memory data transfer
- **4 MODES DATA TRANSFER:** WIRELESS to MDS app (Windows, Android, iOS, MacOS); WIRELESS HID, WIRELESS HID+MAC, USB HID
- **Calibration** certificate included (ISO17025 (Ilac MRA))

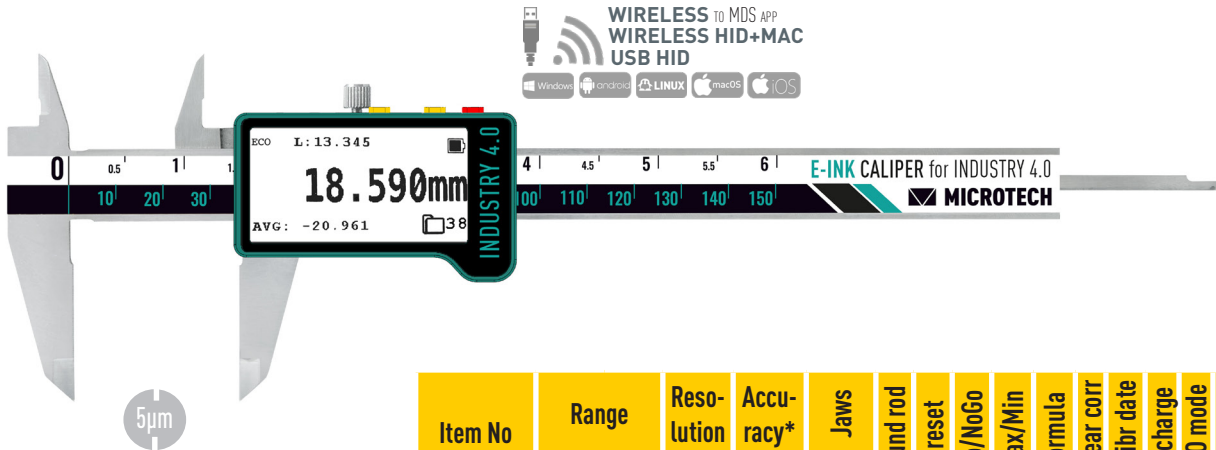

Item No	Range		Reso- lution	Accu- racy*	Jaws	Round rod	Preset	Go/NoGo	Max/Min	Formula	Linear corr	Calibr date	Recharge	ECO mode	Memory	Statistics	WIRELESS	USB HID		
	mm	inch																	mm	µm
141093015B	0-150	0-6"	0,005	±15	40/16		•	•	•	•	•	•	•	•	1000 val	•	•	•		
141093015R					•	•	•	•	•	•	•	•	•	•		•	•	•	•	
141093020B	0-200	0-8"			50/17	•	•	•	•	•	•	•	•	•		•	•	•	•	•
141093030B	0-300	0-12"			±20	•	•	•	•	•	•	•	•	•		•	•	•	•	•

**E-INK CALIPER CARBIDE JAWS**

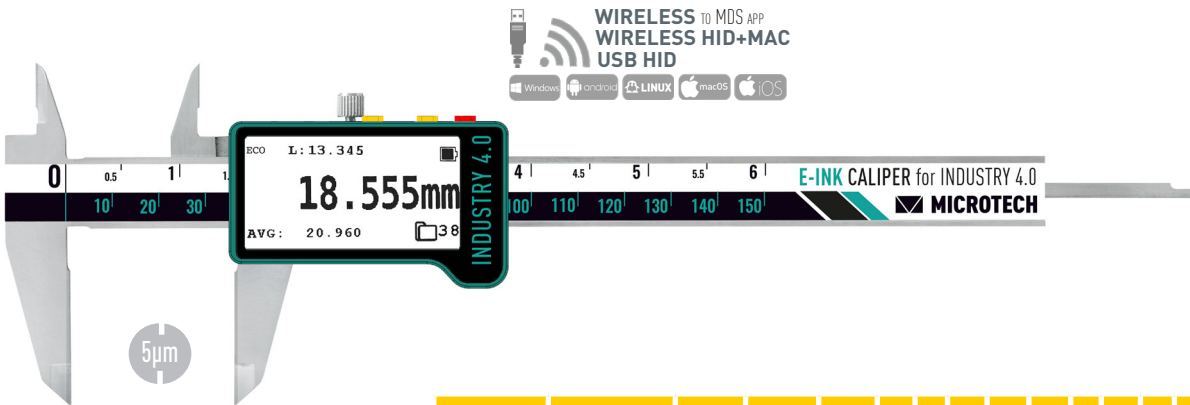

UPPER AND LOWER  
CARBIDE JAWS

Item No	Range		Reso- lution	Accu- racy*	Jaws	Carbide jaws	Preset	Go/NoGo	Max/Min	Formula	Linear corr	Calibr date	Recharge	ECO mode	Memory	Statistics	WIRELESS	USB HID	
	mm	inch																	mm
141093015C	0-150	0-6"	0,005	±15	40/16	•	•	•	•	•	•	•	•	•	1000 val	•	•	•	
141093020C	0-200	0-8"			50/17	•	•	•	•	•	•	•	•	•		•	•	•	•
141093030C	0-300	0-12"			±20	•	•	•	•	•	•	•	•	•		•	•	•	•

**OPTIONAL ACCESSORIES**



ACCESSORIES FOR DATA TRANSFER



IoT MDS CONNECT DISPLAY UNIT  
USB, WI-FI, RJ-45, RS-485, LoRA OUTPUT



IoT DATA BUTTON

**DOWNLOAD APP**



\*Accuracy on external jaws. Internal jaws and Depth according ISO13385-1

- **Industry 4.0** adopted Intelligent caliper with computerized MICS system (Patents US10184772, UA174949, UA126928)
- **ENERGY ECONOMY** 2.13" E-ink display (200+ working hours / 1 charging)
- **Functions:** Go/NoGo, Max/Min, Formula, Timer, Linear correction, Resolution selecting, Connection indication
- **Memory manager:** 1000 values, Statistics mode, Memory data transfer
- Modification with **Double Force** control module with 8N external and 4N internal FORCE
- **4 MODES DATA TRANSFER:** WIRELESS to MDS app (Windows, Android, iOS, MacOS); WIRELESS HID, WIRELESS HID+MAC, USB HID
- **Calibration** certificate included (ISO17025 (Ilac MRA))

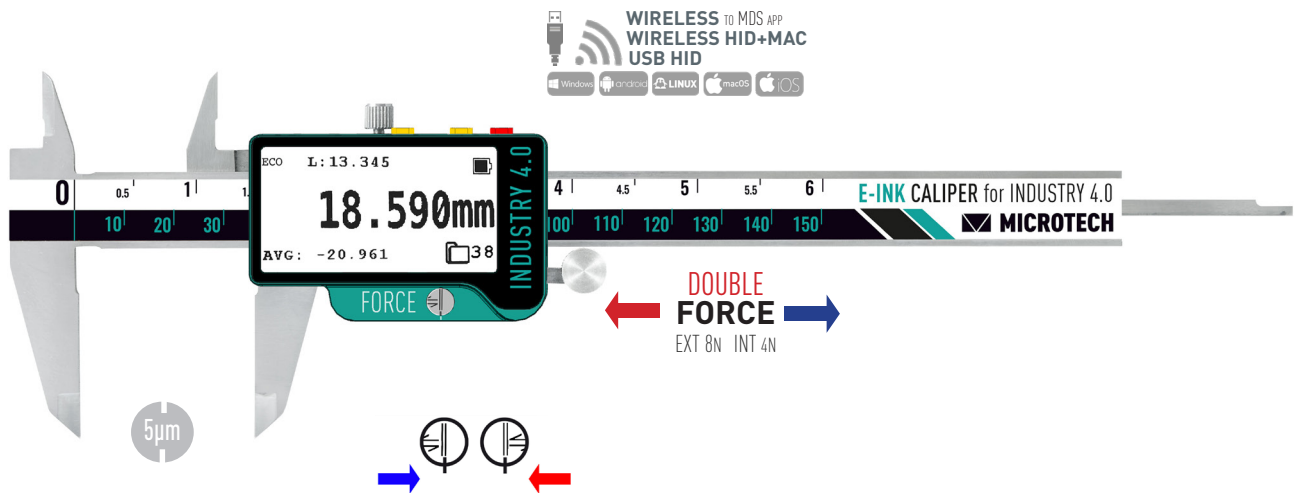

Item No	Range		Reso- lution	Accu- racy*	Force	Jaws	Round rod	Preset	Go/NoGo	Max/Min	Formula	Linear corr	Calibr date	Recharge	ECO mode	Memory	Statistics	WIRELESS	USB HID		
	mm	inch																		mm	µm
141093015F	0-150	0-6"	0,005	±10	8 / 4	40/16	•	•	•	•	•	•	•	•	•	1000 val	•	•	•		
141093015FR						•	•	•	•	•	•	•	•	•	•		•	•	•	•	•
141093020F	0-200	0-8"				50/17	•	•	•	•	•	•	•	•	•		•	•	•	•	•
141093030F	0-300	0-12"				±15	60/20	•	•	•	•	•	•	•	•		•	•	•	•	•

## OPTIONAL ACCESSORIES

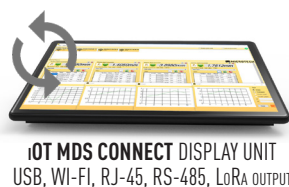

## DOWNLOAD APP



\*Accuracy on external jaws. Internal jaws and Depth according ISO13385-1

- Double Force control module with 8N external and 4N internal FORCE (Patents US10429165, UA146381)
- Waterproof IP67 Swiss electronics with 0.001mm resolution
- High accuracy up to  $\pm 5\mu\text{m}$  on external jaws (internal and depth according ISO13385)
- Calibration certificate included (ISO17025 (Ilac MRA))

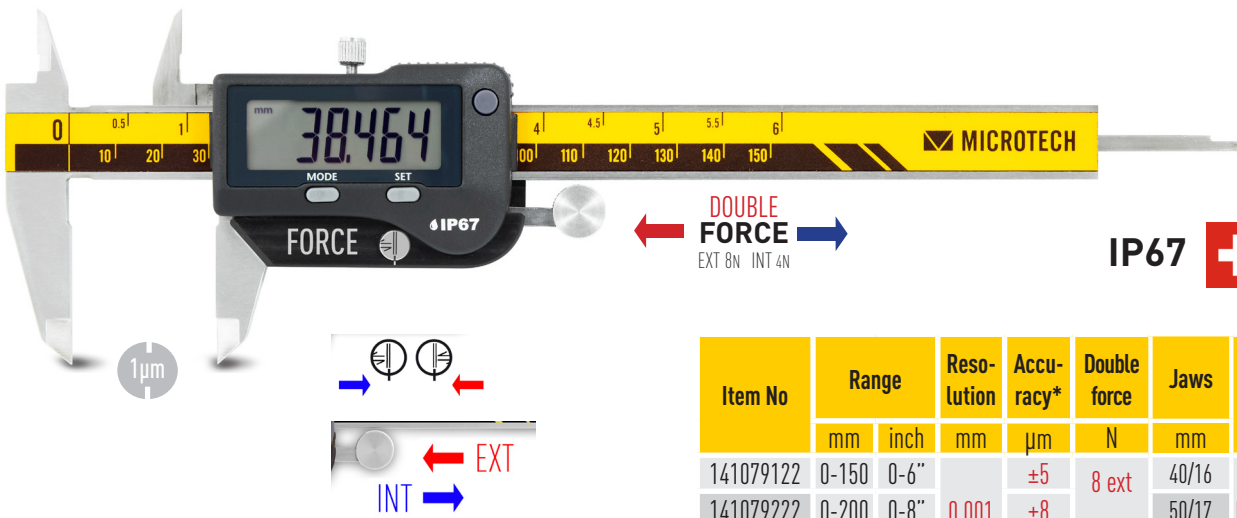

Item No	Range		Reso- lution	Accu- racy*	Double force	Jaws	Protection	Preset	mm/inch	Auto on/off
	mm	inch								
141079122	0-150	0-6"		$\pm 5$	8 ext	40/16		•	•	•
141079222	0-200	0-8"	0,001	$\pm 8$		50/17	IP-67	•	•	•
141079322	0-300	0-12"		$\pm 10$	4 int	60/20		•	•	•

MICRON WIRELESS DOUBLE FORCE CALIPER IP67

- Double Force control module with 8N external and 4N internal FORCE (Patents US10429165, UA146381)
- High accuracy up to  $\pm 5\mu\text{m}$  on external jaws (internal and depth according ISO13385)
- Waterproof IP67 Swiss electronics with 0.001mm resolution and built-in MICROTECH WIRELESS data transfer module
- 3 MODES DATA TRANSFER: WIRELESS to MDS app (Windows, Android, iOS, MacOS); WIRELESS HID, WIRELESS HID+MAC
- Calibration certificate included (ISO17025 (Ilac MRA))

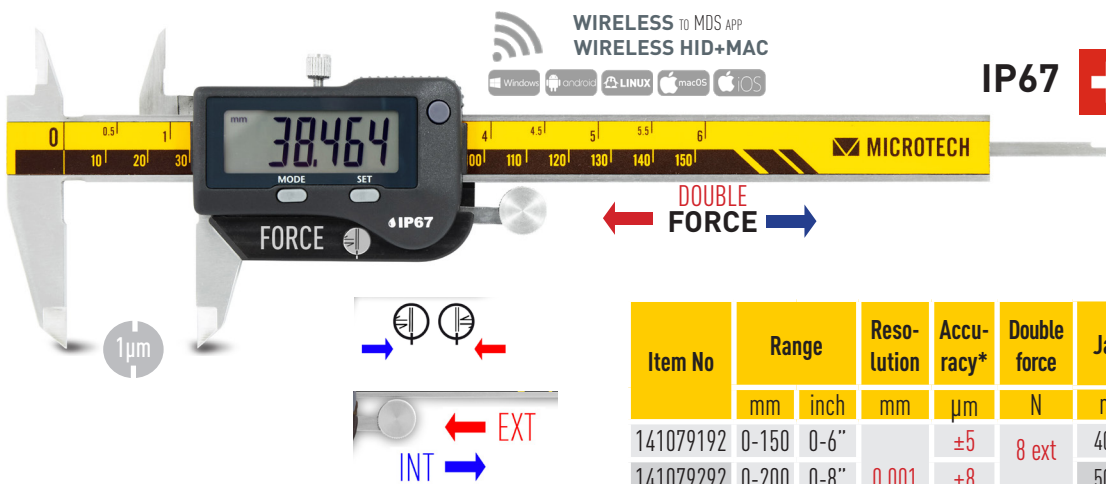

Item No	Range		Reso- lution	Accu- racy*	Double force	Jaws	Protection	Preset	mm/inch	Auto on/off	WIRELESS
	mm	inch									
141079192	0-150	0-6"		$\pm 5$	8 ext	40/16		•	•	•	•
141079292	0-200	0-8"	0,001	$\pm 8$		50/17	IP-67	•	•	•	•
141079392	0-300	0-12"		$\pm 10$	4 int	60/20		•	•	•	•

OPTIONAL ACCESSORIES



iOT MDS CONNECT DISPLAY UNIT  
USB, WI-FI, RJ-45, RS-485, LoRa OUTPUT

DOWNLOAD APP



\*Accuracy on external jaws. Internal jaws and Depth according ISO13385-1



- Double Force control module with 8N external and 4N internal FORCE (Patents US10429165, UA146381)
- Waterproof IP67 Swiss electronics with 0.01 resolution
- High accuracy up to  $\pm 10\mu\text{m}$  on external jaws (internal and depth according ISO13385)
- Calibration certificate included (ISO17025 (Ilac MRA))

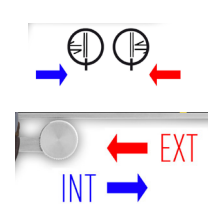

**DOUBLE FORCE**  
EXT 8N INT 4N

**IP67**  **SWISS ELECTRONICS**

Item No	Range		Resolution	Accuracy*	Double force	Jaws	Protection	Preset	mm/inch	Auto on/off
	mm	inch								
141078122	0-150	0-6"	0,01	$\pm 10$	8 ext	40/16	IP-67	•	•	•
141078222	0-200	0-8"		$\pm 10$	50/17	•		•	•	
141078322	0-300	0-12"		$\pm 20$	4 int	60/20		•	•	•

WIRELESS DOUBLE FORCE CALIPER IP67

- Double Force control module with 8N external and 4N internal FORCE (Patents US10429165, UA146381)
- High accuracy up to  $\pm 10\mu\text{m}$  on external jaws (internal and depth according ISO13385)
- Waterproof IP67 Swiss electronics with 0.01mm resolution and built-in MICROTECH WIRELESS data transfer module
- **3 MODES DATA TRANSFER:** WIRELESS to MDS app (Windows, Android, iOS, MacOS); WIRELESS HID, WIRELESS HID+MAC
- Calibration certificate included (ISO17025 (Ilac MRA))

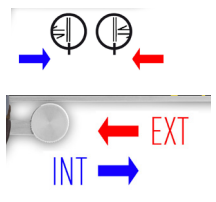

Item No	Range		Resolution	Accuracy*	Double force	Jaws	Protection	Preset	mm/inch	Auto on/off	WIRELESS
	mm	inch									
141078192	0-150	0-6"	0,01	$\pm 10$	8 ext	40/16	IP-67	•	•	•	•
141078292	0-200	0-8"		$\pm 10$	50/17	•		•	•		
141078392	0-300	0-12"		$\pm 20$	4 int	60/20		•	•	•	

**IP67**  **SWISS ELECTRONICS**

OPTIONAL ACCESSORIES

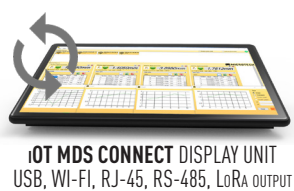



DOWNLOAD APP

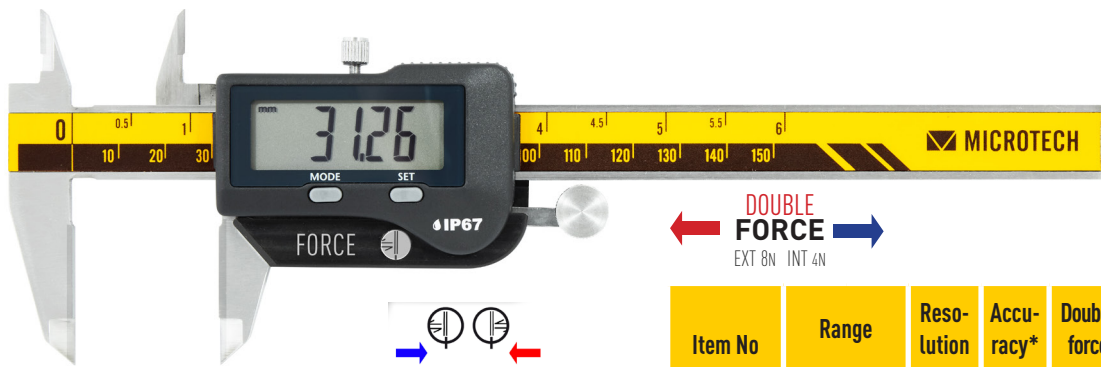

\*Accuracy on external jaws. Internal jaws and Depth according ISO13385-1

- **Double Force** control module with 8N external and 4N internal FORCE (Patents US10429165, UA146381)
- Upper and Lower carbide jaws
- Waterproof **IP67** Swiss electronics with 0.01mm resolution
- High accuracy up to  $\pm 10\mu\text{m}$  on external jaws (internal and depth according ISO13385)
- **Calibration** certificate included (ISO17025 (Ilac MRA))



**IP67**  **SWISS ELECTRONICS**

**DOUBLE FORCE**  
EXT 8N INT 4N

UPPER AND LOWER CARBIDE JAWS

Item No	Range		Reso- lution	Accu- racy*	Double force	Jaws	Protection	Preset	mm/inch	Auto on/off
	mm	inch	mm	$\mu\text{m}$	N	mm				
141078122C	0-150	0-6"	0,01	$\pm 10$	8 ext	40/16	IP-67	•	•	•
141078222C	0-200	0-8"		$\pm 10$	4 int	50/17				
141078322C	0-300	0-12"		$\pm 20$	4 int	60/20				

**WIRELESS** DOUBLE FORCE CALIPER IP67 **CARBIDE JAWS**

- **Double Force** control module with 8N external and 4N internal FORCE (Patents US10429165, UA146381)
- Upper and Lower carbide jaws
- High accuracy up to  $\pm 10\mu\text{m}$  on external jaws (internal and depth according ISO13385)
- Waterproof **IP67** Swiss electronics with 0.01mm resolution and built-in MICROTECH **WIRELESS** data transfer module
- **3 MODES DATA TRANSFER:** WIRELESS to MDS app (Windows, Android, iOS, MacOS); WIRELESS HID, WIRELESS HID+MAC
- **Calibration** certificate included (ISO17025 (Ilac MRA))



**WIRELESS TO MDS APP**  
**WIRELESS HID+MAC**

Windows Android LINUX macOS iOS

**IP67**  **SWISS ELECTRONICS**

**DOUBLE FORCE**  
EXT 8N INT 4N

UPPER AND LOWER CARBIDE JAWS

Item No	Range		Reso- lution	Accu- racy*	Double force	Jaws	Protection	Preset	mm/inch	Auto on/off	WIRELESS
	mm	inch	mm	$\mu\text{m}$	N	mm					
141078192C	0-150	0-6"	0,01	$\pm 10$	8 ext	40/16	IP-67	•	•	•	•
141078292C	0-200	0-8"		$\pm 10$	4 int	50/17					
141078392C	0-300	0-12"		$\pm 20$	4 int	60/20					

**OPTIONAL ACCESSORIES**

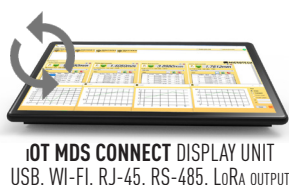

**DOWNLOAD APP**



\*Accuracy on external jaws. Internal jaws and Depth according ISO13385-1

- Double **LOW Force** control module with 0.8N external and 1N internal FORCE for SOFT materials (Patents US10429165)
- Waterproof **IP67** Swiss electronics
- **Calibration** certificate included (ISO17025 (Ilac MRA))



FOR SOFT MATERIALS

Item No	Range		Reso- lution	Accu- racy*	Double Low force N	Jaws mm	Protection	Preset	mm/inch	Auto on/off
	mm	inch								
141077153	0-150	0-6"	0,01	±30	0,8 ext	40/16	IP-67	•	•	•
141077253	0-200	0-8"		±30		50/17		•	•	•
141077353	0-300	0-12"		±40	1 int	60/20		•	•	•

**WIRELESS** DOUBLE **LOW FORCE** CALIPER IP67

- Double **LOW Force** control module with 0.8N external and 1N internal FORCE for SOFT materials (Patents US10429165)
- Waterproof **IP67** Swiss electronics with PRESET function and built-in MICROTECH **WIRELESS** data transfer module
- **3 MODES DATA TRANSFER**: **WIRELESS** to MDS app (Windows, Android, iOS, MacOS); **WIRELESS HID**, **WIRELESS HID+MAC**
- **Calibration** certificate included (ISO17025 (Ilac MRA))

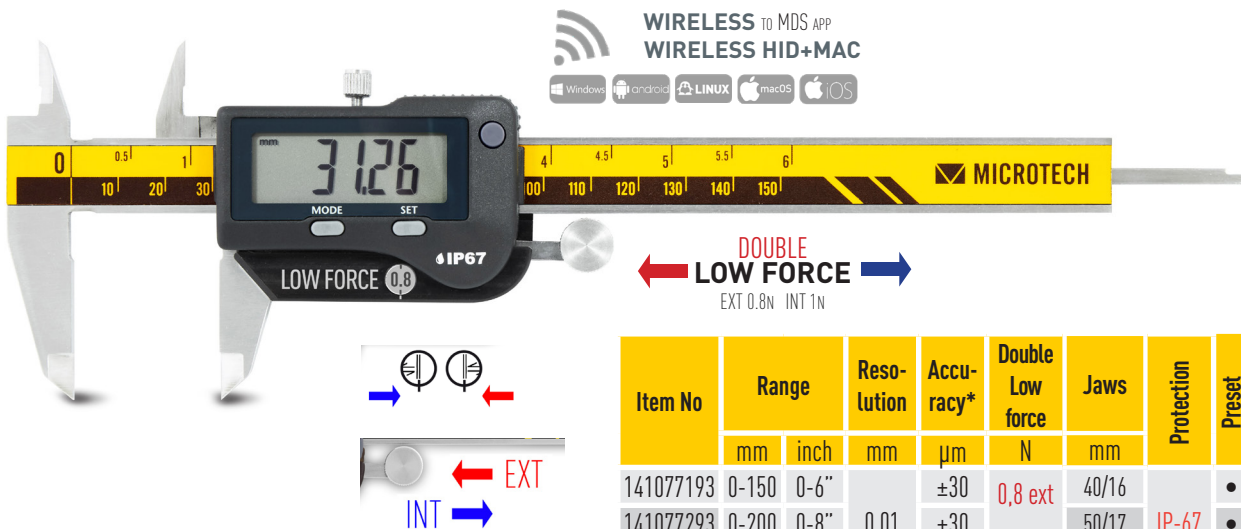

FOR SOFT MATERIALS

Item No	Range		Reso- lution	Accu- racy*	Double Low force N	Jaws mm	Protection	Preset	mm/inch	Auto on/off	WIRELESS
	mm	inch									
141077193	0-150	0-6"	0,01	±30	0,8 ext	40/16	IP-67	•	•	•	•
141077293	0-200	0-8"		±30		50/17		•	•	•	
141077393	0-300	0-12"		±40	1 int	60/20		•	•	•	

OPTIONAL ACCESSORIES

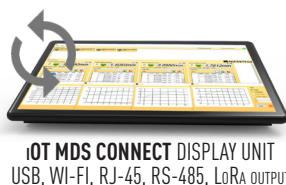

DOWNLOAD APP



- Waterproof IP67 Swiss electronics with PRESET function
- High accuracy up to  $\pm 20\mu\text{m}$  on external jaws (internal and depth according ISO13385)
- Calibration certificate included (ISO17025 (Ilac MRA))

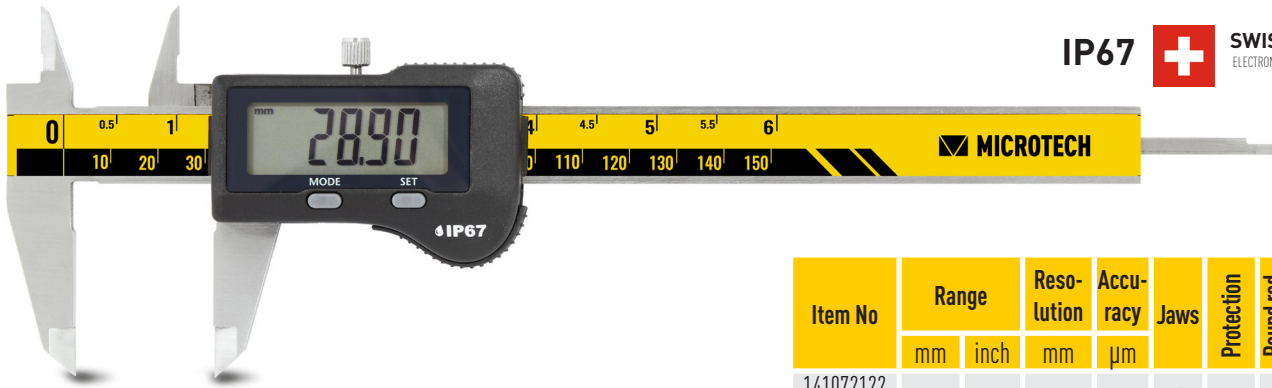

IP67  SWISS ELECTRONICS

Item No	Range		Reso- lution	Accu- racy	Jaws	Protection	Round rod	Preset	mm/inch	Auto on/off
	mm	inch								
141072122	0-150	0-6"	0,01	$\pm 20$	40/16	IP-67		•	•	•
141072122R							•	•	•	
141072222	0-200	0-8"		$\pm 20$	50/17		•	•	•	
141072322	0-300	0-12"		$\pm 30$	60/20		•	•	•	

MICRON DIGITAL CALIPER IP67



IP67  SWISS ELECTRONICS

Item No	Range		Reso- lution	Accu- racy	Jaws	Protection	Round rod	Preset	mm/inch	Auto on/off
	mm	inch								
141073122	0-150	0-6"	0,001	$\pm 15$	40/16	IP-67		•	•	•
141073122R							•	•	•	
141073222	0-200	0-8"		$\pm 15$	50/17		•	•	•	
141073322	0-300	0-12"		$\pm 20$	60/20		•	•	•	

PRECISION DIGITAL CALIPER IP67 CARBIDE JAWS

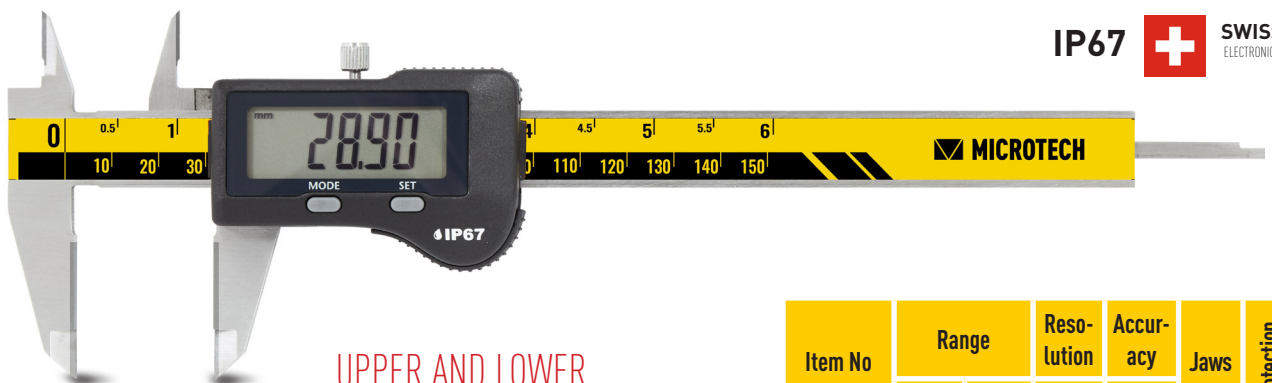

IP67  SWISS ELECTRONICS

UPPER AND LOWER  
CARBIDE JAWS

Item No	Range		Reso- lution	Accu- racy	Jaws	Protection	Preset	mm/inch	Auto on/off
	mm	inch							
141072122C	0-150	0-6"	0,01	$\pm 20$	40/16	IP-67		•	•
141072222C	0-200	0-8"		$\pm 20$	50/17		•	•	
141072322C	0-300	0-12"		$\pm 30$	60/20		•	•	

- Waterproof **IP67** Swiss electronics with PRESET function and built-in MICROTECH **WIRELESS** data transfer module
- High accuracy up to  $\pm 20\mu\text{m}$  on external jaws (internal and depth according ISO13385)
- **3 MODES DATA TRANSFER:** WIRELESS to MDS app (Windows, Android, iOS, MacOS); WIRELESS HID, WIRELESS HID+MAC
- **Calibration** certificate included (ISO17025 (Ilac MRA))



Item No	Range		Reso- lution	Accu- racy	Jaws	Protection	Round rod	Preset	mm/inch	Auto on/off	WIRELESS	
	mm	inch	mm	$\mu\text{m}$								
141072192	0-150	0-6"	0,01	$\pm 20$	40/16	IP-67		•	•	•	•	
141072192R								•	•	•	•	•
141072292	0-200	0-8"		$\pm 20$	50/17				•	•	•	•
141072392	0-300	0-12"		$\pm 30$	60/20				•	•	•	•

## MICRON WIRELESS DIGITAL CALIPER IP67



Item No	Range		Reso- lution	Accu- racy	Jaws	Protection	Round rod	Preset	mm/inch	Auto on/off	WIRELESS	
	mm	inch	mm	$\mu\text{m}$								
141073192	0-150	0-6"	0,001	$\pm 15$	40/16	IP-67		•	•	•	•	
141073192R								•	•	•	•	•
141073292	0-200	0-8"		$\pm 15$	50/17				•	•	•	•
141073392	0-300	0-12"		$\pm 20$	60/20				•	•	•	•

## WIRELESS DIGITAL CALIPER IP67 CARBIDE JAWS



UPPER AND LOWER  
CARBIDE JAWS

Item No	Range		Reso- lution	Accu- racy	Jaws	Protection	Preset	mm/inch	Auto on/off	WIRELESS	
	mm	inch	mm	$\mu\text{m}$							
141072192C	0-150	0-6"	0,01	$\pm 20$	40/16	IP-67		•	•	•	
141072292C	0-200	0-8"		$\pm 20$	50/17				•	•	•
141072392C	0-300	0-12"		$\pm 30$	60/20				•	•	•

### OPTIONAL ACCESSORIES



ACCESSORIES FOR DATA TRANSFER



IoT MDS CONNECT DISPLAY UNIT  
USB, WI-FI, RJ-45, RS-485, LoRa OUTPUT

\*Accuracy on external jaws. Internal jaws and Depth according ISO13385-1

### DOWNLOAD APP



- High quality Big screen digital caliper IP54 waterproof with optimal price level
- Micro USB data output (optional USB HID cable **29900830**)
- Calibration certificate included (ISO17025 (Ilac MRA))



Item No	Range		Reso- lution	Accu- racy	Jaws	Protection	Thumb roller	Round rod	Thumb roll	mm/inch	Auto on/off	USB
	mm	inch	mm	µm								
141083111												
141083112	0-150	0-6"		±20	40/16							
141083112R												
141083211	0-200	0-8"	0,01	±20	50/17	IP-54						
141083212												
141083311	0-300	0-12"		±30	60/20							
141083312												

**BIG SCREEN** DIGITAL CALIPER IP54 **CARBIDE JAWS**



UPPER AND LOWER  
CARBIDE JAWS

Item No	Range		Reso- lution	Accu- racy	Jaws	Protection	Thumb roll	mm/inch	Auto on/off	USB
	mm	inch	mm	µm						
141083111C	0-150	0-6"		±20	40/16					
141083212C	0-200	0-8"	0,01	±20	50/17	IP-54				
141083312C	0-300	0-12"		±30	60/20					

**OPTIONAL ACCESSORIES**



**141083000** USB HID DATA TRANSFER CABLE 2.5M  
DIRECT DATA TRANSFER, LIKE A KEYBOARD

# PRESET DIGITAL CALIPER IP54

- Digital caliper IP54 waterproof with PRESET function
- Micro USB data output (optional USB HID cable **29900830**)
- Calibration certificate included (ISO17025 (Ilac MRA))



PRESET  
FUNCTION

## OPTIONAL ACCESSORIES



**141083000** USB HID DATA TRANSFER CABLE 2.5M  
DIRECT DATA TRANSFER, LIKE A KEYBOARD

Item No	Range		Reso- lution	Accu- racy	Jaws	Protection	Round rod	Preset	mm/inch	Auto on/off	USB
	mm	inch									
141081112	0-150	0-6"	0,01	±20	40/16	IP-54					
141081112R				±20	50/17						
141081212	0-200	0-8"		±20	60/20						
141081312	0-300	0-12"		±30	60/20						

# WIRELESS CALIPER IP54

- IP54 electronics with PRESET function and built-in MICROTECH **WIRELESS** data transfer module
- **3 MODES DATA TRANSFER:** WIRELESS to MDS app (Windows, Android, iOS, MacOS); WIRELESS HID, WIRELESS HID+MAC
- WIRELESS mode status LED indication
- Calibration certificate included (ISO17025 (Ilac MRA))



PRESET  
FUNCTION

WIRELESS TO MDS APP  
WIRELESS HID+MAC

**WIRELESS** MODE SWITCH **7s**

- WIRELESS to MDS app
- WIRELESS ECO to MDS app
- WIRELESS HID
- WIRELESS HID+MAC

Item No	Range		Reso- lution	Accu- racy	Jaws	Protection	Round rod	mm/inch	Auto on/off	WIRELESS
	mm	inch								
141081192	0-150	0-6"	0,01	±20	40/16	IP-54				
141081192R				±20	50/17					
141081292	0-200	0-8"		±20	60/20					
141081392	0-300	0-12"		±30	60/20					

## OPTIONAL ACCESSORIES

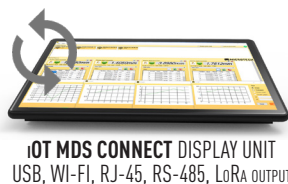

## DOWNLOAD APP



\*Accuracy on external jaws. Internal jaws and Depth according ISO13385-1

MADE IN UKRAINE

- MICRON digital caliper
- Waterproof **IP67** electronics with **1µm** resolution
- **Calibration** certificate included (ISO17025 (Ilac MRA))

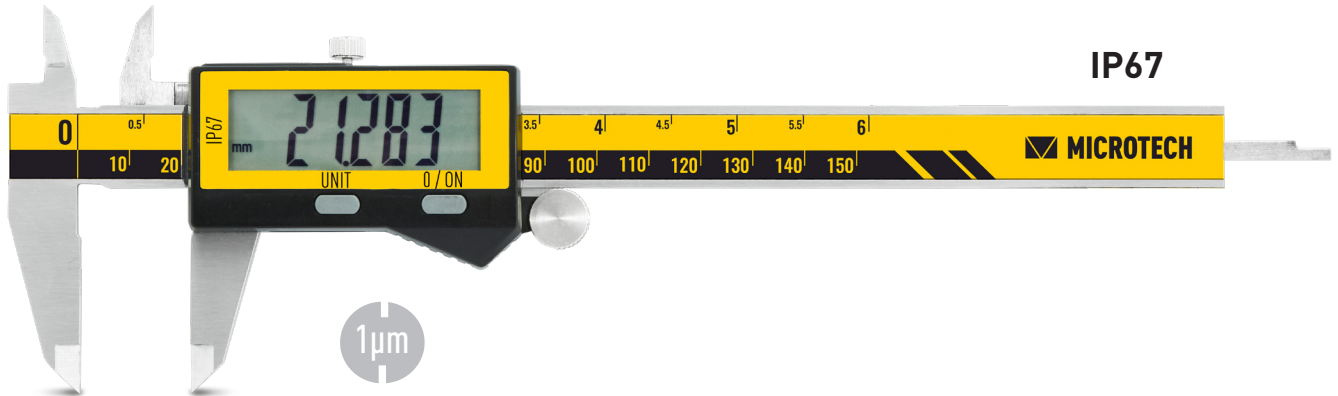

Item No	Range		Reso- lution	Accu- racy	Jaws	Protection	Thumb roll	mm/inch	Auto on/off
	mm	inch	mm	µm					
141075112	0-150	0-6"		±15	40/16		•	•	•
141075212	0-200	0-8"	0,001	±15	50/17	IP67	•	•	•
141075312	0-300	0-12"		±20	60/20		•	•	•

**RECHARGEABLE** DIGITAL CALIPER IP54

- **RECHARGEABLE** Big screen digital caliper **IP54** waterproof in Metal casing
- Internal Li-Pol battery (USB charging cable including)
- Micro USB data output (optional USB HID cable **29900830**)
- **Calibration** certificate included (ISO17025 (Ilac MRA))



**OPTIONAL ACCESSORIES**



**141083000** USB HID DATA TRANSFER CABLE 2.5M  
DIRECT DATA TRANSFER, LIKE A KEYBOARD

Item No	Range		Reso- lution	Accu- racy	Jaws	Protection	Thumb roller	Thumb roll	mm/inch	Auto on/off	Rechargeable	USB
	mm	inch	mm	µm								
141080112	0-150	0-6"		±20	40/16		•	•	•	•	•	•
141080212	0-200	0-8"	0,01	±20	50/17	IP-54	•	•	•	•	•	•
141080312	0-300	0-12"		±30	60/20		•	•	•	•	•	micro-USB



# PRECISION DIGITAL CALIPER IP67

- Waterproof **IP67** electronics with **5µm** or **10µm** resolution
- **HOLD** function
- **Calibration** certificate included (ISO17025 (Ilac MRA))

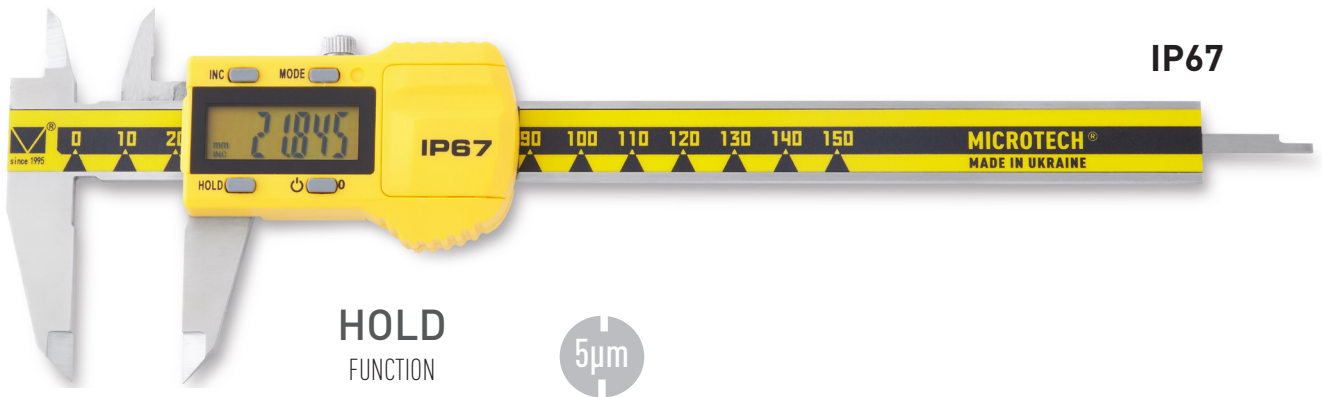

Item No	Range		Reso- lution	Accu- racy	Jaws	mm/inch	Auto on/off	HOLD
	mm	inch	mm	µm				
141085102	0-150	0-6"	0,01	±20	40/16	•	•	•
141085112			0,005					
141085202	0-200	0-8"	0,01	±20	50/17	•	•	•
141085212			0,005					
141085302	0-300	0-12"	0,01	±30	60/20	•	•	•
141085312			0,005					

# DIAL CALIPER

- Shockproof dial caliper
- **Calibration** certificate included (ISO17025 (Ilac MRA))



Item No	Range	Resolution	Accuracy	Display	Shock proof	Thumb roller
	mm	mm	µm			
141011150	0-150	0,01	±30	Dial	•	•
141011200	0-200		±30			
141011301	0-300	0,02	±40			

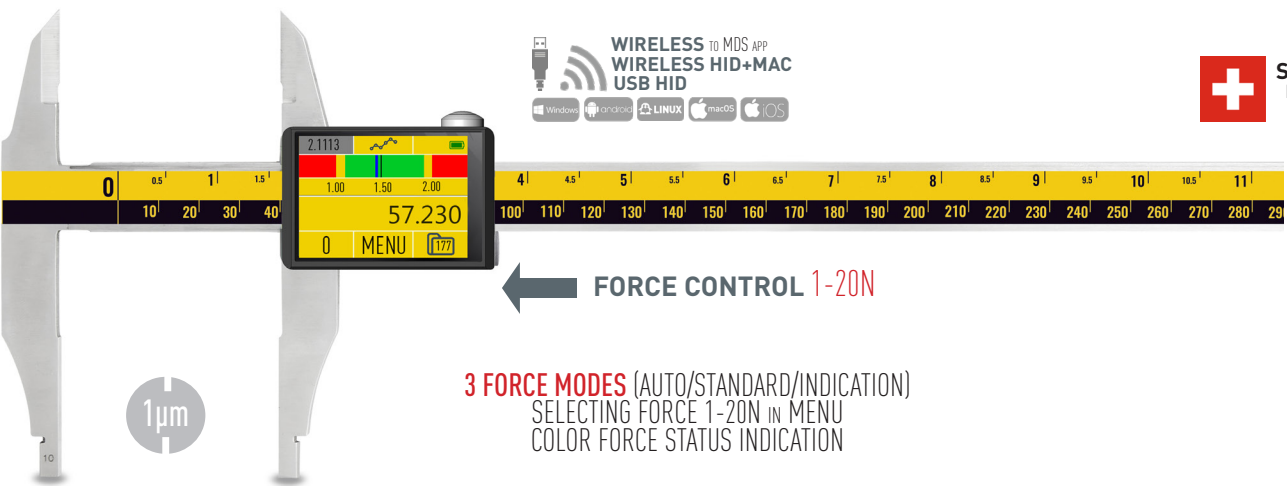

Item No	Range		Reso- lution	Accu- racy*	Force	Jaws	Preset	Go/NoGo	Max/Min	Formula	Timer	Temp comp	Linear corr	Calibr date	Recharge	Auto off	Password	Memory	Statistics	WIRELESS	USB HID	
	mm	inch																				mm
141088321A	0-300	0-12"	0,001	±12	1-20	60/40	•	•	•	•	•	•	•	•	•	•	•	•	•	•	•	•

COMPUTERIZED E-FORCE CALIPER POINTS JAWS

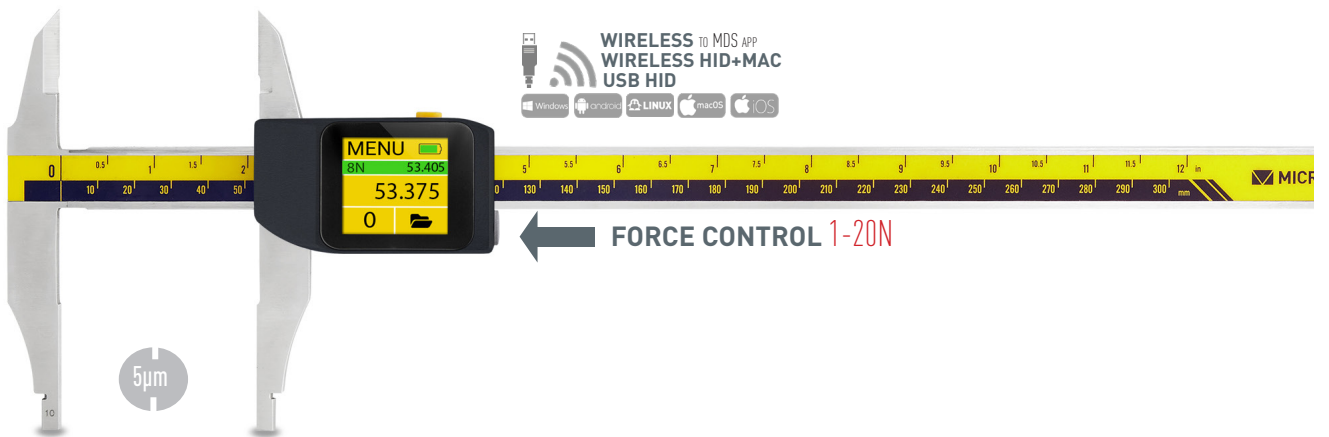

Item No	Range		Reso- lution	Accu- racy*	Force	Jaws	Preset	Go/NoGo	Max/Min	Formula	Timer	Temp comp	Linear corr	Calibr date	Recharge	Auto off	Memory	Statistics	WIRELESS	USB HID	
	mm	inch																			mm
141077321A	0-300	0-12"	0,005	±15	1-20	60/40	•	•	•	•	•	•	•	•	•	•	•	•	•	•	•

OPTIONAL ACCESSORIES

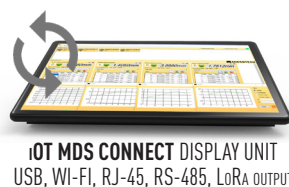

DOWNLOAD APP



\*Accuracy on external jaws. Internal jaws and Depth according ISO13385-1

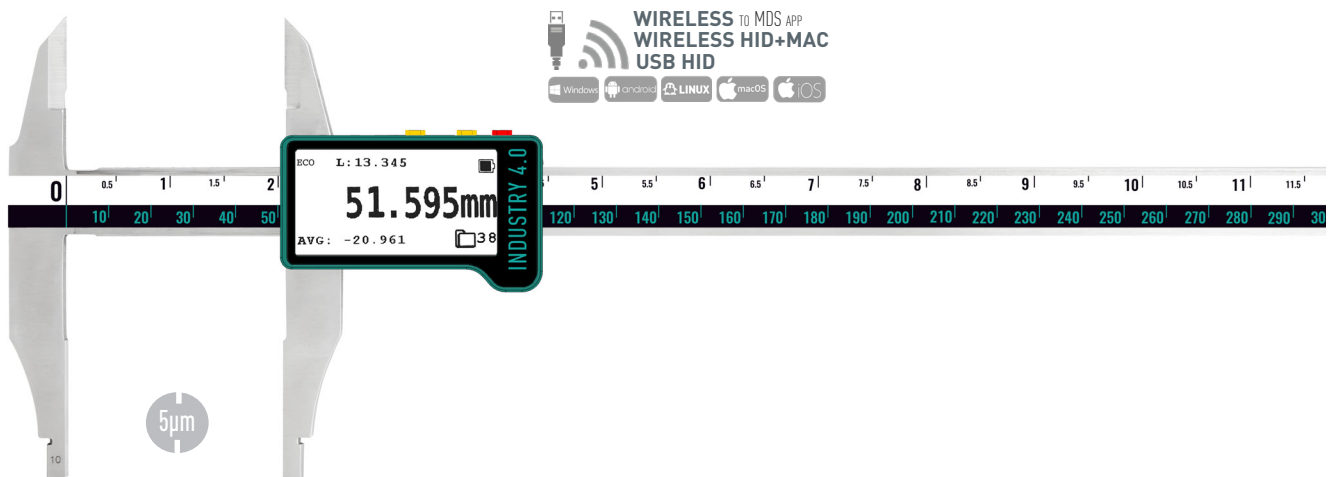

Item No	Range		Reso- lution	Accu- racy*	Jaws	Protection	Preset	Go/NoGo	Max/Min	Formula	Timer	Temp comp	Linear corr	Calibr date	Recharge	Auto off	Memory	Statistics	WIRELESS	USB HID	
	mm	inch																			mm
141093321B	0-300	0-12"	0,005	±15	60/40	IP54	•	•	•	•	•	•	•	•	•	•	•	•	•	•	•

# E-INK FORCE CALIPER POINTS JAWS

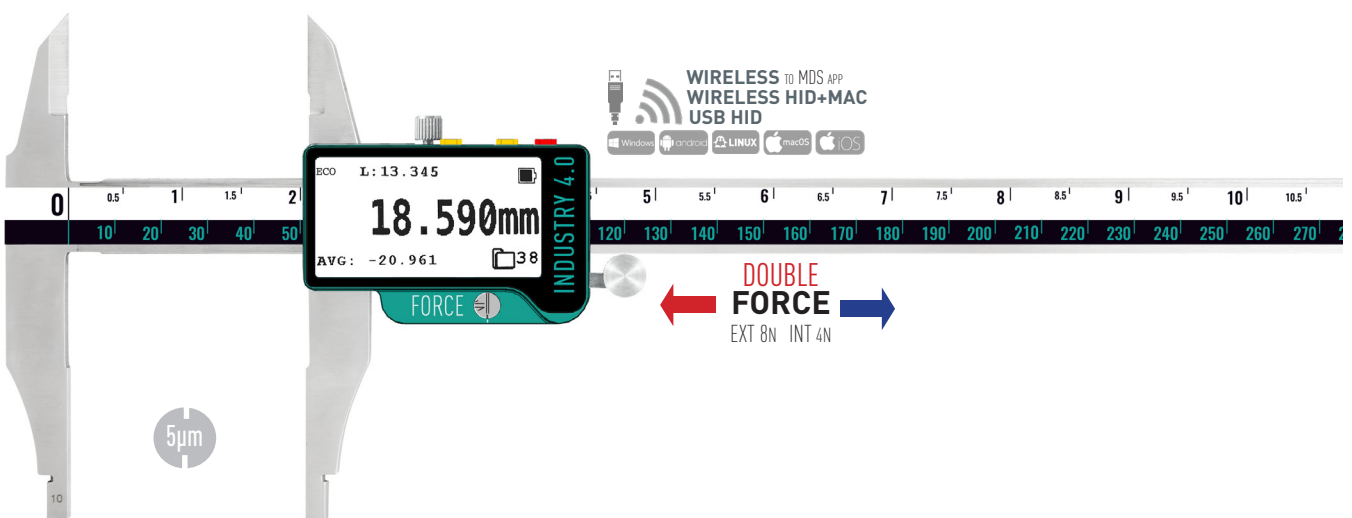

Item No	Range		Reso- lution	Accu- racy*	Force	Jaws	Protection	Preset	Go/NoGo	Max/Min	Formula	Timer	Temp comp	Linear corr	Calibr date	Recharge	Auto off	Memory	Statistics	WIRELESS	
	mm	inch																			mm
141093321F	0-300	0-12"	0,005	±20	8 / 4	60/40	IP54	•	•	•	•	•	•	•	•	•	•	•	•	•	•

## OPTIONAL ACCESSORIES

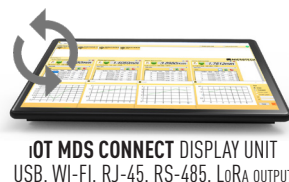

## DOWNLOAD APP



\*Accuracy on external jaws. Internal jaws and Depth according ISO13385-1

MADE IN UKRAINE



IP67  SWISS ELECTRONICS

Item No	Range		Reso- lution	Accu- racy*	Double force	Jaws	Protection	Preset	mm/inch	Auto on/off
	mm	inch	mm	µm	N	mm				
141078323	0-300	0-12"	0,01	±20	8 ext 4 int	60/40	IP-67	•	•	•

MICRON DOUBLE FORCE CALIPER IP67 POINTS JAWS

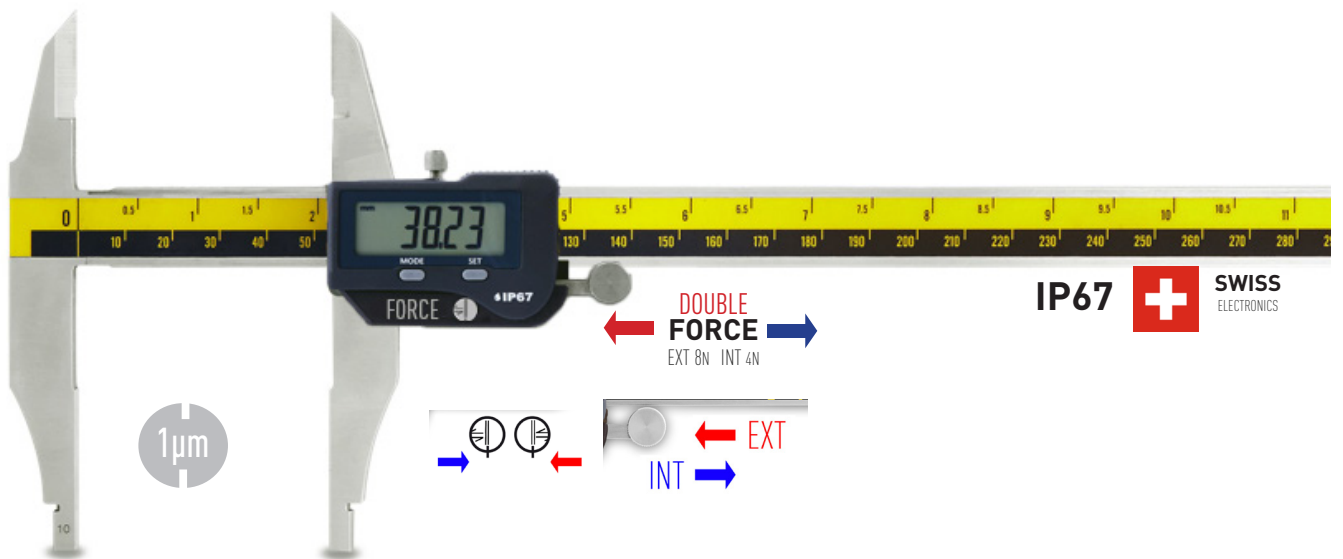

IP67  SWISS ELECTRONICS

Item No	Range		Reso- lution	Accu- racy*	Double force	Jaws	Protection	Preset	mm/inch	Auto on/off
	mm	inch	mm	µm	N	mm				
141079323	0-300	0-12"	0,001	±12	8 ext 4 int	60/40	IP-67	•	•	•

# WIRELESS DOUBLE FORCE CALIPER IP67 POINTS JAWS

MICROTECH 



WIRELESS TO MDS APP  
WIRELESS HID+MAC

Windows Android LINUX macOS iOS

IP67  SWISS ELECTRONICS

DOUBLE FORCE  
EXT 8N INT 4N



Item No	Range		Reso- lution	Accu- racy*	Double force	Jaws	Protection	Preset	mm/inch	Auto on/off	WIRELESS
	mm	inch	mm	µm	N	mm					
141078393	0-300	0-12"	0,01	±20	8 ext 4 int	60/40	IP-67	•	•	•	•

# MICRON WIRELESS DOUBLE FORCE CALIPER IP67 POINTS JAWS



WIRELESS TO MDS APP  
WIRELESS HID+MAC

Windows Android LINUX macOS iOS

IP67  SWISS ELECTRONICS

DOUBLE FORCE  
EXT 8N INT 4N

1µm



Item No	Range		Reso- lution	Accu- racy*	Double force	Jaws	Protection	Preset	mm/inch	Auto on/off	WIRELESS
	mm	inch	mm	µm	N	mm					
141079393	0-300	0-12"	0,001	±12	8 ext 4 int	60/40	IP-67	•	•	•	•

## OPTIONAL ACCESSORIES



IoT MDS CONNECT DISPLAY UNIT  
USB, WI-FI, RJ-45, RS-485, LoRa OUTPUT



IoT DATA BUTTON

## DOWNLOAD APP



MADE IN UKRAINE



IP67  SWISS ELECTRONICS

Item No	Range		Reso- lution	Accu- racy*	Jaws	Protection	Preset	mm/inch	Auto on/off
	mm	inch	mm	µm	mm				
141072323	0-300	0-12"	0,01	±30	60/40	IP67	•	•	•

MICRON DIGITAL CALIPER IP67 POINTS JAWS



IP67  SWISS ELECTRONICS

Item No	Range		Reso- lution	Accu- racy*	Jaws	Protection	Preset	mm/inch	Auto on/off
	mm	inch	mm	µm	mm				
141073323	0-300	0-12"	0,001	±20	60/40	IP67	•	•	•

WIRELESS DIGITAL CALIPER IP67 POINTS JAWS



WIRELESS TO MDS APP  
WIRELESS HID+MAC  
Windows Android LINUX macOS iOS

IP67  SWISS ELECTRONICS

Item No	Range		Reso- lution	Accu- racy*	Jaws	Protection	Preset	mm/inch	Auto on/off	WIRELESS
	mm	inch	mm	µm	mm					
141072393	0-300	0-12"	0,01	±40	60/40	IP67	•	•	•	•

OPTIONAL ACCESSORIES



IoT MDS CONNECT DISPLAY UNIT  
USB, WI-FI, RJ-45, RS-485, LoRa OUTPUT

DOWNLOAD APP



# PRESET DIGITAL CALIPER IP54 POINTS JAWS

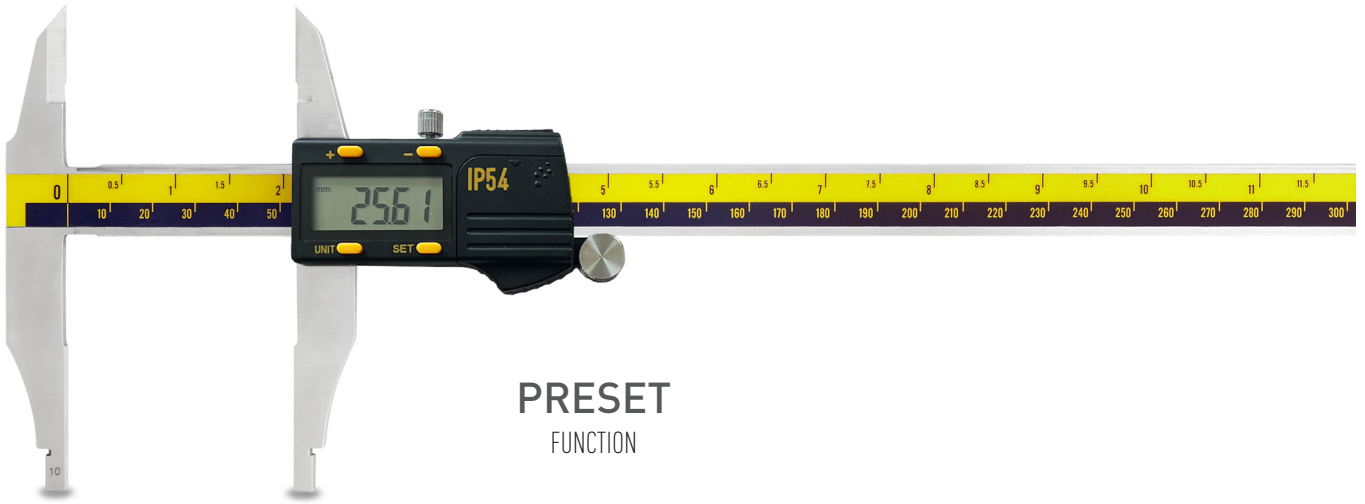

PRESET  
FUNCTION

Item No	Range		Reso- lution	Accu- racy*	Jaws	Protection	Thumb roller	Pre- set	mm/inch	Auto on/off	USB
	mm	inch	mm	µm	mm						
141083321	0-300	0-12"	0,01	±30	60/40	IP-54	•	•	•	•	•

## OPTIONAL ACCESSORIES



141083000 USB HID DATA TRANSFER CABLE 2.5M  
DIRECT DATA TRANSFER, LIKE A KEYBOARD

# WIRELESS CALIPER IP54 POINTS JAWS



WIRELESS TO MDS APP  
WIRELESS HID+MAC  
Windows Android LINUX macOS iOS

PRESET  
FUNCTION

- WIRELESS MODE SWITCH 7s
- WIRELESS to MDS app
- WIRELESS ECO to MDS app
- WIRELESS HID
- WIRELESS HID+MAC

Item No	Range		Reso- lution	Accu- racy*	Jaws	Protection	Thumb roller	Pre- set	mm/inch	Auto on/off	WIRELESS
	mm	inch	mm	µm	mm						
141083391	0-300	0-12"	0,01	±30	60/40	IP54	•	•	•	•	•

## OPTIONAL ACCESSORIES

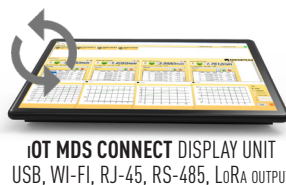

## DOWNLOAD APP



- Light 100mm jaw digital caliper with waterproof IP67 Swiss electronics with PRESET function
- Calibration certificate included (ISO17025 (Ilac MRA))



IP67  SWISS ELECTRONICS

Item No	Range		Resol	Jaw	Accur.	Bar section	Weight	Protection	mm/inch	Preset	ABS
	mm	inch									
141072311	0-300	0-12"					0,69		•	•	•
141072411	0-400	0-16"	0,01	100	±30	17x5	0,79	IP67	•	•	•
141072511	0-500	0-20"					0,88		•	•	•

MICRON LIGHT LONG JAW DIGITAL CALIPER IP67

- Light 100mm jaw MICRON digital caliper with waterproof IP67 Swiss electronics with PRESET function
- Calibration certificate included (ISO17025 (Ilac MRA))



IP67  SWISS ELECTRONICS

Item No	Range		Resol	Jaw	Accur.	Bar section	Weight	Protection	mm/inch	Preset	ABS
	mm	inch									
141072331	0-300	0-12"					0,69		•	•	•
141072431	0-400	0-16"	0,001	100	±20	17x5	0,79	IP67	•	•	•
141072531	0-500	0-20"					0,88		•	•	•

WIRELESS LIGHT LONG JAW DIGITAL CALIPER IP67

- Light 100mm jaw digital caliper with waterproof IP67 Swiss electronics with PRESET function
- 3 MODES DATA TRANSFER: WIRELESS to MDS app (Windows, Android, iOS, MacOS); WIRELESS HID, WIRELESS HID+MAC
- Calibration certificate included (ISO17025 (Ilac MRA))



IP67  SWISS ELECTRONICS



Item No	Range		Resol	Jaw	Accur.	Bar section	Weight	Protection	mm/inch	ABS	WIRELESS
	mm	inch									
141072391	0-300	0-12"					0,69		•	•	•
141072491	0-400	0-16"	0,01	100	±30	17x5	0,79	IP67	•	•	•
141072591	0-500	0-20"					0,88		•	•	•



# LONG JAW DIGITAL CALIPER IP67



**IP67** **SWISS ELECTRONICS**

- Long jaw digital caliper with waterproof **IP67** Swiss electronics with PRESET function
- SWISS electronics in Aluminium casing
- **Calibration** certificate included (ISO17025 (Ilac MRA))

Item No	Range		Resol	Jaw	Accur.	Bar section	Weight	Protection	mm/inch	Preset	ABS
	mm	inch									
141073512	0-500	0-20"	0,01	150	±30	23x6	1,7	IP67 Al case	•	•	•
141073515				300	±40		2,7		•	•	•
141073611	100	±30		1,7	•		•		•		
141073712	0-1000	0-40"		150	±40	32x7	3,3		•	•	•
141073715				300	±60		5,7		•	•	•
141073812	0-1500	0-60"		150	±50	42x8	5,2		•	•	•
141073815				300	±70		7,1		•	•	•
141073912	150	±60		7,1	•		•		•		
141073915	±80	8,6		•	•		•				
141073255	0-2500	0-100'		±90	•	•	•				
141073305	0-3000	0-120'		300	±100	53x8	•		•	•	
141073405	0-4000	0-160'			±130		•		•	•	
141073505	0-5000	0-200'	±160		•		•	•			

# WIRELESS LONG JAW DIGITAL CALIPER IP67

**WIRELESS TO MDS APP**  
**WIRELESS HID+MAC**

Windows Android LINUX macOS iOS



**IP67** **SWISS ELECTRONICS**

- Long jaw digital caliper with waterproof **IP67** Swiss electronics with PRESET function
- SWISS electronics in Aluminium casing
- **3 MODES DATA TRANSFER:** WIRELESS to MDS app (Windows, Android, iOS, MacOS); WIRELESS HID, WIRELESS HID+MAC
- **Calibration** certificate included (ISO17025 (Ilac MRA))

Item No	Range		Resol	Jaw	Accur.	Bar section	Weight	Protection	mm/inch	Preset	ABS	WIRELESS
	mm	inch										
141073592	0-500	0-20"	0,01	150	±30	23x6	1,75	IP67 Al case	•	•	•	•
141073595				300	±40		2,65		•	•	•	
141073691	100	±30		1,66	•		•		•			
141073792	0-1000	0-40"		150	±40	32x7	3,32		•	•	•	
141073795				300	±60		5,70		•	•	•	
141073892	0-1500	0-60"		150	±50	42x8	•		•	•		
141073895				300	±70		•		•	•		
141073992	150	±60		•	•		•					
141073995	±80	•		•	•		•					
141073265	0-2500	0-100'		±90	•	•	•					
141073315	0-3000	0-120'		300	±100	53x8	•		•	•		
141073415	0-4000	0-160'			±130		•		•	•		
141073515	0-5000	0-200'	±160		•		•	•				

## OPTIONAL ACCESSORIES



## DOWNLOAD APP



- MICRON Long jaw digital caliper with waterproof IP67 Swiss electronics with PRESET function
- SWISS electronics in Aluminium casing with 0.001mm resolution
- Calibration certificate included (ISO17025 (Ilac MRA))

IP67  SWISS ELECTRONICS

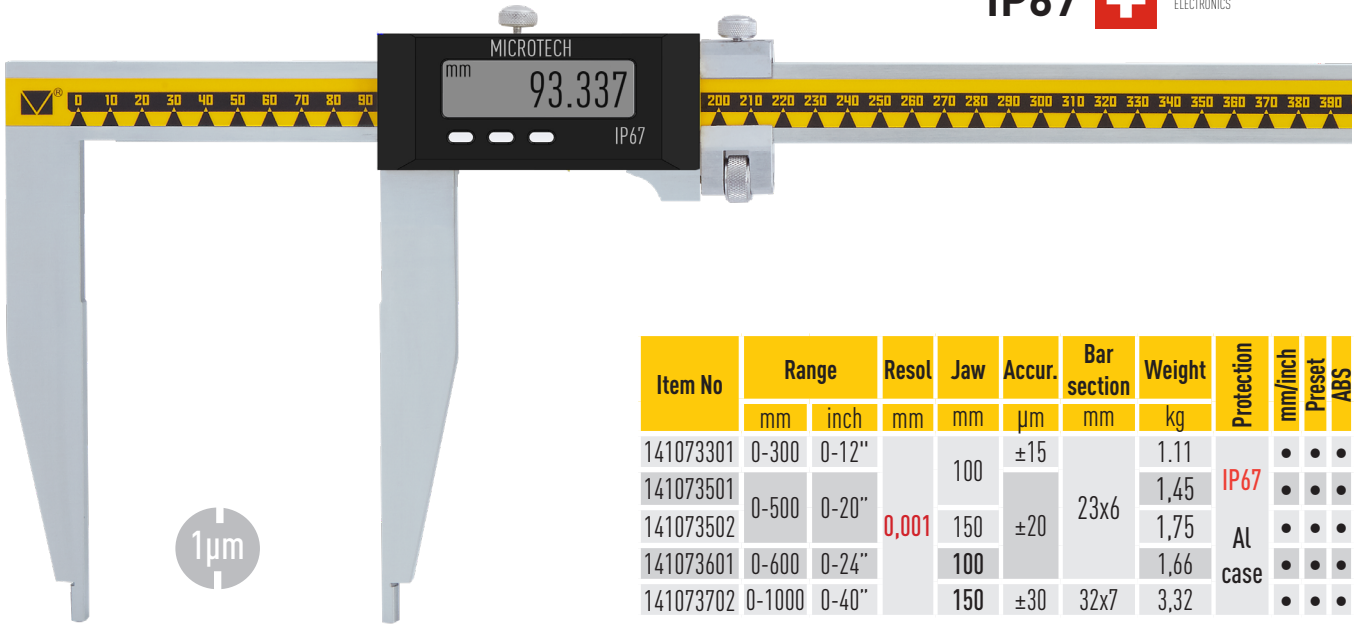

Item No	Range		Resol	Jaw	Accur.	Bar section	Weight	Protection	mm/inch	Preset	ABS
	mm	inch									
141073301	0-300	0-12"	0,001	100	±15	23x6	1,11	IP67 Al case	• • •	• • •	• • •
141073501	0-500	0-20"		150	±20		1,45				
141073502							1,75				
141073601	0-600	0-24"		100	±30	32x7	1,66				
141073702	0-1000	0-40"		150			3,32				

MICRON FORCE LONG JAW DIGITAL CALIPER IP67

- MICRON Long jaw digital caliper with waterproof IP67 Swiss electronics with PRESET function
- Force control module with 8N external FORCE (Patents US10429165, UA146381)
- SWISS electronics in Aluminium casing with 0.001mm resolution
- Calibration certificate included (ISO17025 (Ilac MRA))

IP67  SWISS ELECTRONICS

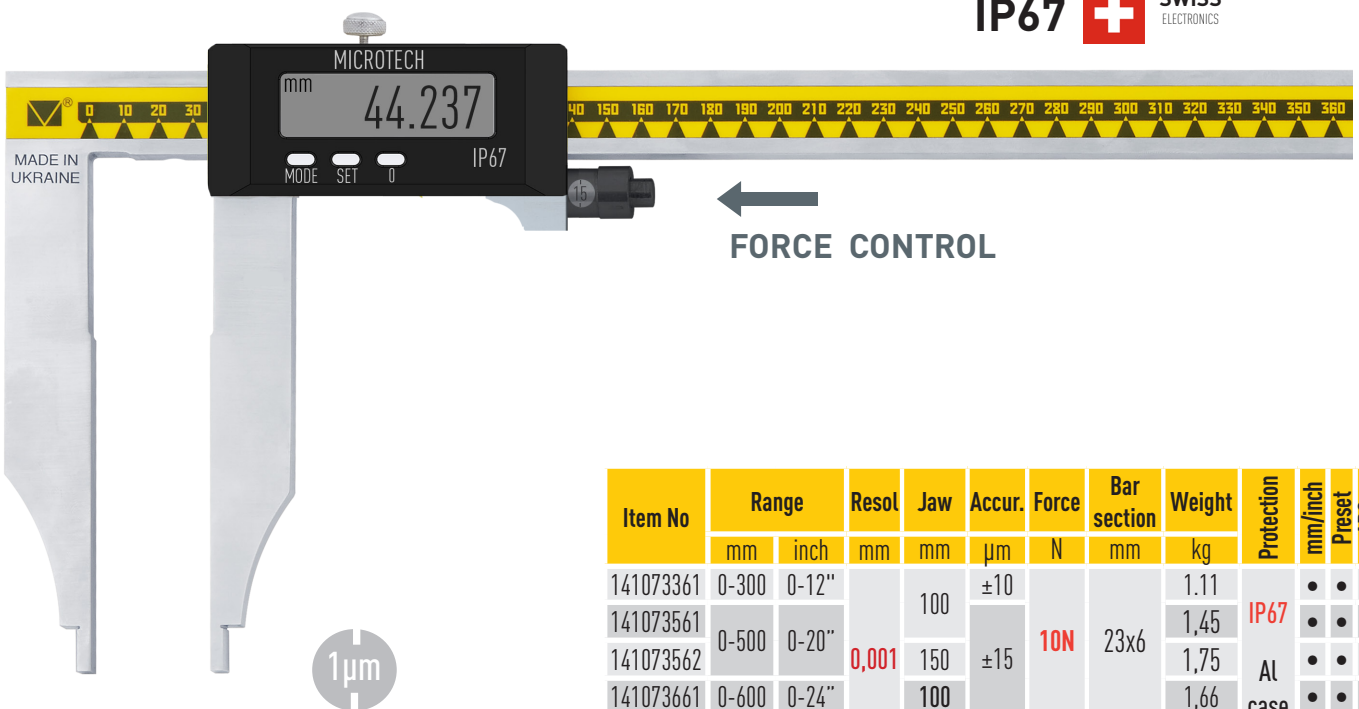

Item No	Range		Resol	Jaw	Accur.	Force	Bar section	Weight	Protection	mm/inch	Preset	ABS
	mm	inch										
141073361	0-300	0-12"	0,001	100	±10	10N	23x6	1,11	IP67 Al case	• • •	• • •	• • •
141073561	0-500	0-20"		150	±15			1,45				
141073562								1,75				
141073661	0-600	0-24"		100	±20	15N	32x7	1,66				
141073762	0-1000	0-40"		150				3,32				

# WIRELESS MICRON LONG JAW DIGITAL CALIPER IP67

MICROTECH 

- MICRON Long jaw digital caliper with waterproof IP67 Swiss electronics with PRESET function
- SWISS electronics in Aluminium casing with 0.001mm resolution
- **3 MODES DATA TRANSFER:** WIRELESS to MDS app (Windows, Android, iOS, MacOS); WIRELESS HID, WIRELESS HID+MAC
- Calibration certificate included (ISO17025 (Ilac MRA))

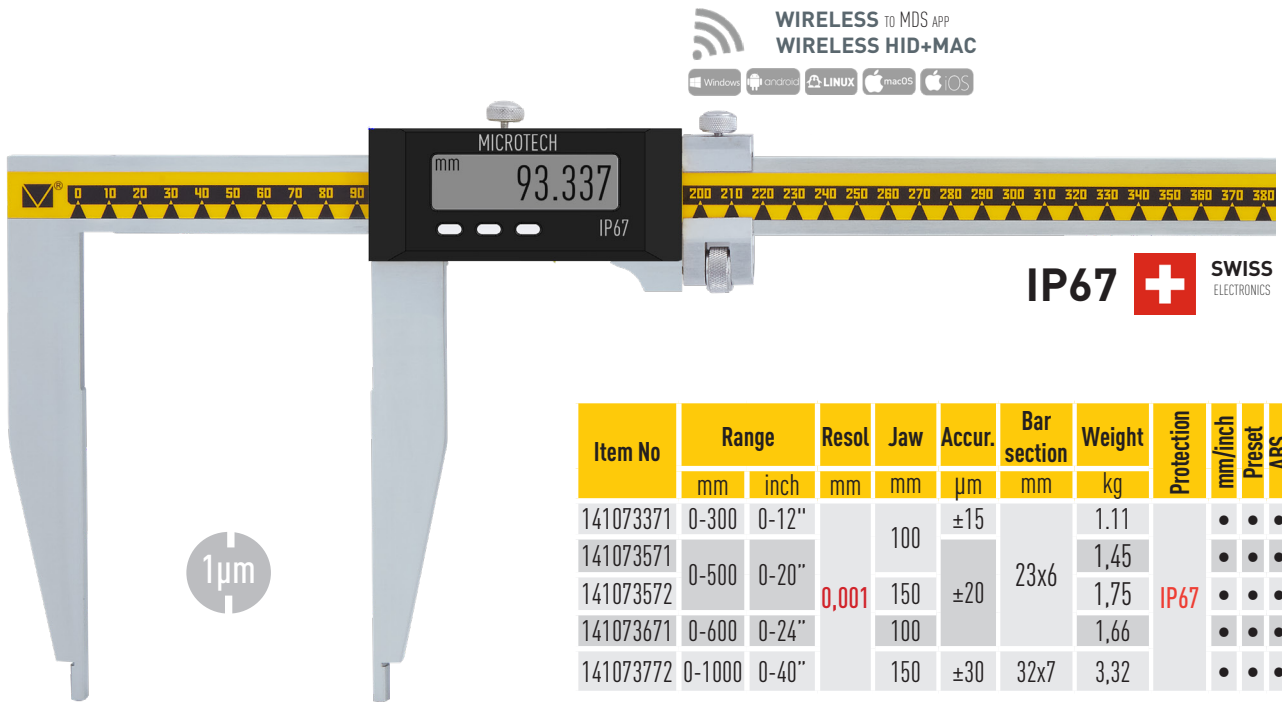

WIRELESS TO MDS APP  
WIRELESS HID+MAC

Windows Android LINUX macOS iOS

MICROTECH  
mm 93.337  
IP67

IP67  SWISS ELECTRONICS

Item No	Range		Resol	Jaw	Accur.	Bar section	Weight	Protection	mm/inch	Preset	ABS	WIRELESS
	mm	inch										
141073371	0-300	0-12"	0,001	100	±15	23x6	1,11	IP67	•	•	•	•
141073571	0-500	0-20"		150	±20		1,45		•	•	•	•
141073572							1,75		•	•	•	•
141073671	0-600	0-24"		100	±30		1,66		•	•	•	•
141073772	0-1000	0-40"		150		32x7	3,32		•	•	•	•

1µm

# WIRELESS MICRON FORCE LONG JAW DIGITAL CALIPER IP67

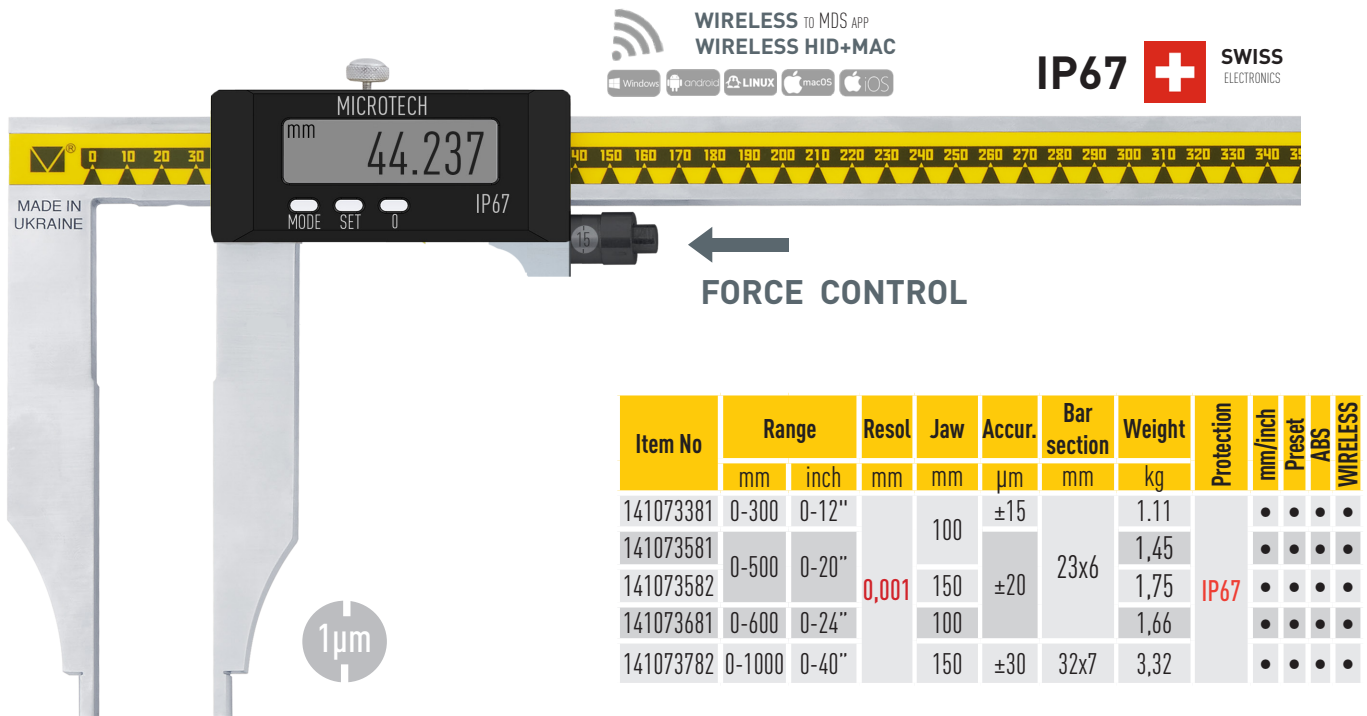

WIRELESS TO MDS APP  
WIRELESS HID+MAC

Windows Android LINUX macOS iOS

MICROTECH  
mm 44.237  
IP67

IP67  SWISS ELECTRONICS

MADE IN UKRAINE

MODE SET 0

FORCE CONTROL

Item No	Range		Resol	Jaw	Accur.	Bar section	Weight	Protection	mm/inch	Preset	ABS	WIRELESS
	mm	inch										
141073381	0-300	0-12"	0,001	100	±15	23x6	1,11	IP67	•	•	•	•
141073581	0-500	0-20"		150	±20		1,45		•	•	•	•
141073582							1,75		•	•	•	
141073681	0-600	0-24"		100	±30		1,66		•	•	•	•
141073782	0-1000	0-40"		150		32x7	3,32		•	•	•	•

1µm

## OPTIONAL ACCESSORIES

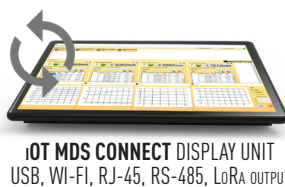

DOWNLOAD APP



MADE IN UKRAINE

- Industry 4.0 adopted Tablet caliper with computerized MICS system with 2.4" color Touchscreen
- Functions: On-line Graphic, Analog scale, Go/NoGo, Max/Min, Formula, Timer, Linear correction, Temperature correction
- Measuring HUB: Wireless MICROTECH instrument connection, Synchronization, 2D mode, 2D Graph, Probe mode, Compensation
- Memory manager: 2000 values, Folders system, Statistics mode, Memory data transfer
- E-Force control module with Force selection 1-20N, color indication, AUTO-Force mode, Force indication
- **4 MODES DATA TRANSFER:** WIRELESS to MDS app (Windows, Android, iOS, MacOS); WIRELESS HID, WIRELESS HID+MAC, USB HID
- Top quality Aluminium housing (CNC machined solid block)
- Calibration certificate included (ISO17025 (Ilac MRA))

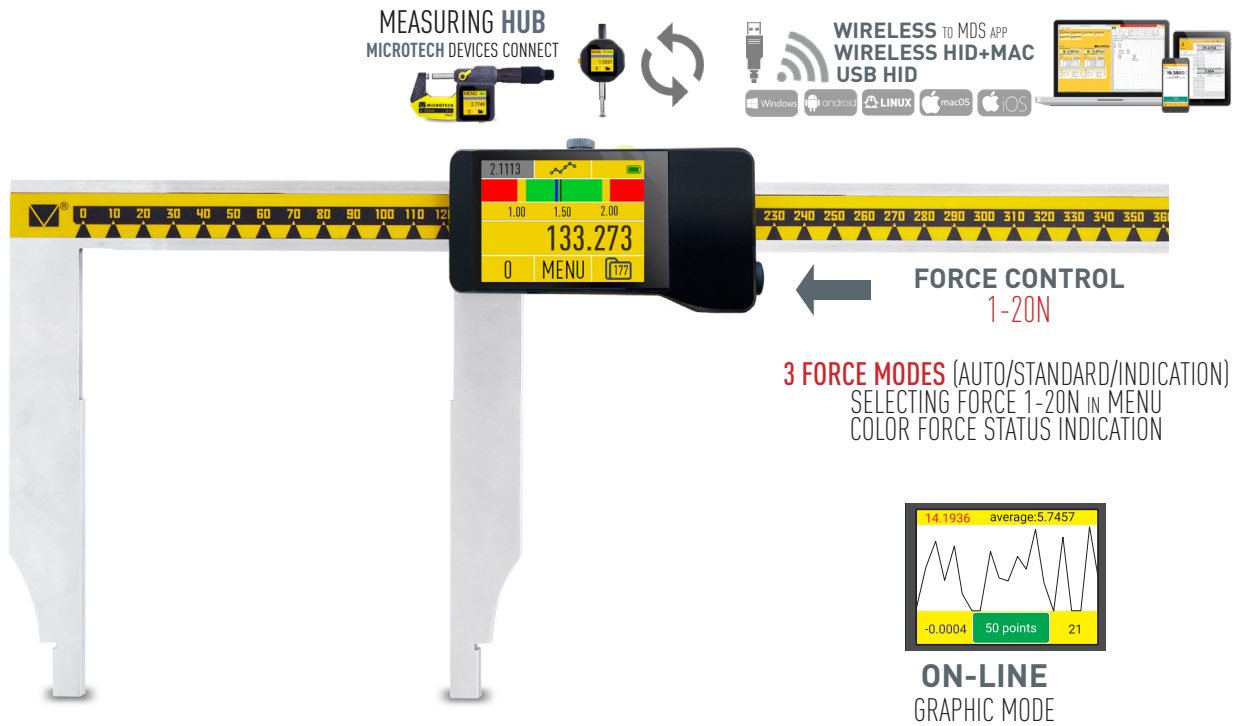

Item No	Range		Resol.	Jaws	Accuracy	eForce	Measuring HUB	Analog scale	Graphic	Preset	Go/NoGo	Max/Min	Formula	Timer	Temp comp	Linear corr	Calibr date	Recharge	Memory	WIRELESS	USB HID	FW update				
	mm	inch																					mm	mm	µm	N
141005216	0-500	0-20"	0,01	100	±30	1-20	•	•	•	•	•	•	•	•	•	•	•	•	•	Folders / 2000 val	Long range / HID	•	•			
141005226				150	±30		•	•	•	•	•	•	•	•	•	•	•	•	•			•	•	•	•	•
141005256				300	±30		•	•	•	•	•	•	•	•	•	•	•	•	•			•	•	•	•	•
141006216	0-630	0-25"		100	±30		•	•	•	•	•	•	•	•	•	•	•	•	•			•	•	•	•	•
141010216				150	±40		•	•	•	•	•	•	•	•	•	•	•	•	•			•	•	•	•	•
141010256	0-1000	0-40"		300	±50		•	•	•	•	•	•	•	•	•	•	•	•	•			•	•	•	•	•
141015216				150	±50		•	•	•	•	•	•	•	•	•	•	•	•	•			•	•	•	•	•
141015256	0-1500	0-60"		300	±60		•	•	•	•	•	•	•	•	•	•	•	•	•			•	•	•	•	•
141020216				150	±50		•	•	•	•	•	•	•	•	•	•	•	•	•			•	•	•	•	•
141020256	0-2000	0-80"		300	±60		•	•	•	•	•	•	•	•	•	•	•	•	•			•	•	•	•	•
141025256			300	±80	•	•	•	•	•	•	•	•	•	•	•	•	•	•	•	•	•	•				
141030256	0-3000	0-120"	300	±90	•	•	•	•	•	•	•	•	•	•	•	•	•	•	•	•	•	•				
141040256			300	±110	•	•	•	•	•	•	•	•	•	•	•	•	•	•	•	•	•	•				
141050256	0-5000	0-200'	300	±130	•	•	•	•	•	•	•	•	•	•	•	•	•	•	•	•	•	•				

**OPTIONAL ACCESSORIES**

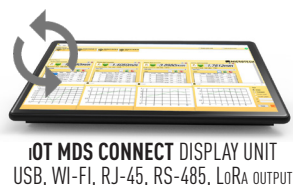

**DOWNLOAD APP**



# MICRON TABLET LONG JAW CALIPER



MEASURING HUB  
MICROTECH DEVICES CONNECT



WIRELESS TO MDS APP  
WIRELESS HID+MAC  
USB HID

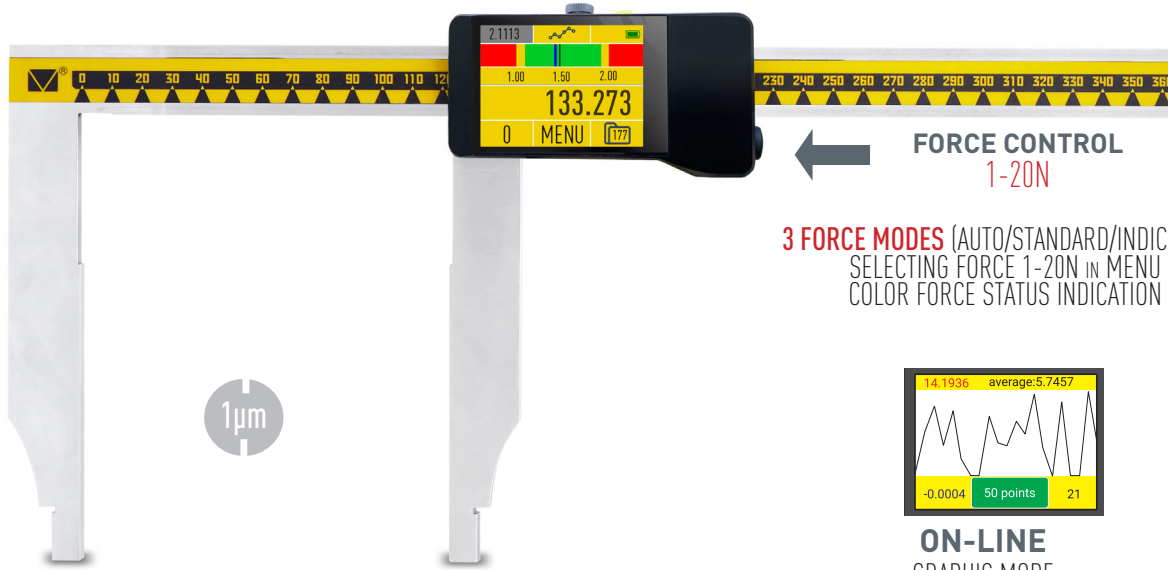

FORCE CONTROL  
1-20N

3 FORCE MODES (AUTO/STANDARD/INDICATION)  
SELECTING FORCE 1-20N IN MENU  
COLOR FORCE STATUS INDICATION

1µm

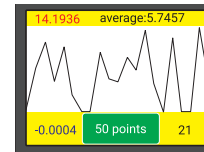

ON-LINE  
GRAPHIC MODE

Item No	Range		Resol.	Jaws	Accuracy	eForce	Measuring HUB	Analog scale	Graphic	Preset	Go/NoGo	Max/Min	Formula	Timer	Temp comp	Linear corr	Calibr date	Recharge	Memory	WIRELESS	USB HID	FW update	
	mm	inch																					mm
141005217			0,001	100	±20	1-20	•	•	•	•	•	•	•	•	•	•	•	•	•	•	•	•	
141005227	0-500	0-20"		150	±20		•	•	•	•	•	•	•	•	•	•	•	•	•	•	•	•	•
141005257				300	±25		•	•	•	•	•	•	•	•	•	•	•	•	•	•	•	•	•
141006217	0-630	0-25"		100	±20		•	•	•	•	•	•	•	•	•	•	•	•	•	•	•	•	•
141010217				150	±30		•	•	•	•	•	•	•	•	•	•	•	•	•	•	•	•	•
141010257	0-1000	0-40"		300	±40		•	•	•	•	•	•	•	•	•	•	•	•	•	•	•	•	•

# MICRON TABLET E-FORCE CALIPER POINTS JAWS

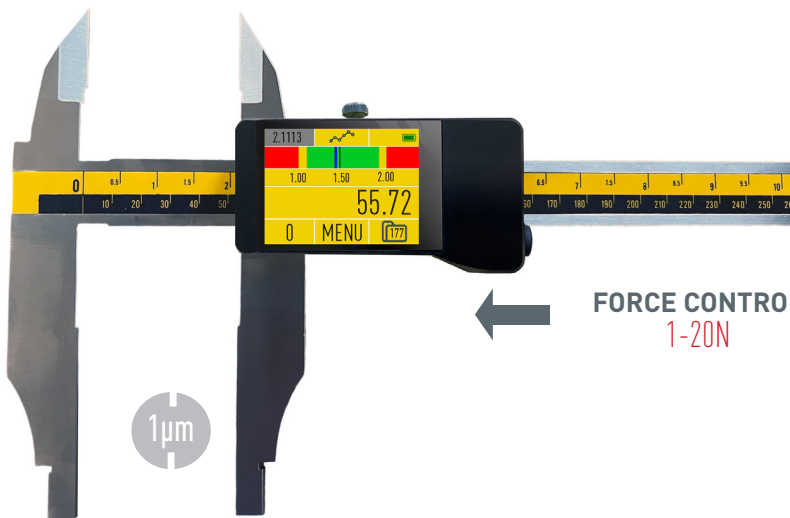

FORCE CONTROL  
1-20N

1µm

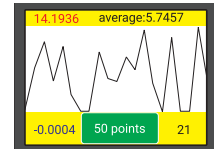

ON-LINE  
GRAPHIC MODE

Item No	Range		Reso- lution	Accu- racy*	Force	Jaws	Preset	Go/NoGo	Max/Min	Formula	Timer	Temp comp	Linear corr	Calibr date	Recharge	Auto off	Password	Memory	Folders	Statistics	WIRELESS	USB HID	FW update
	mm	inch																					
141077521A	0-500	0-20"	0,01	±30	1-20	100/40	•	•	•	•	•	•	•	•	•	•	•	•	•	•	•	•	
141097521A			0,001	±20		•	•	•	•	•	•	•	•	•	•	•	•	•	•	•	•	•	

- Extra Long jaw digital caliper with waterproof **IP67** Swiss electronics in Al case
- Jaw length up to 1000m
- Aluminium construction with precision linear guides
- **Calibration** certificate included (ISO17025 (Ilac MRA))

**IP67**  **SWISS**  
ELECTRONICS



**CUSTOM RANGE AND JAWS FOR REQUEST**

Item No	Range		Resol.	Jaws	Accuracy	Weight	Protection	mm/inch	Preset	ABS	Display
	mm	inch	mm	mm	µm	kg					
142408445	0-800	0-32"	0,001	400	±25	3,9	IP67 Al case	•	•	•	Big screen Swiss electronics IP67 in Al case
142408444			0,01		±30	3,9		•	•	•	
142411445	0-1000	0-40'	0,001	400	±30	4,3		•	•	•	
142411444			0,01		±40	4,3		•	•	•	
142411464				600	±50	4,7		•	•	•	
142418445	0-1800	0-60"	0,001	400	±40	6,2		•	•	•	
142418444			600		±50	6,2		•	•	•	
142418464				600	±60	6,6		•	•	•	
142120144	0-2000	0-80"	0,01	400	±60	17,5		•	•	•	
142120164				600	±85	18,0		•	•	•	
142120104				1000	±120	19,0		•	•	•	
142125144	0-2500	0-100"	0,01	400	±90	20,0		•	•	•	
142125164				600	±105	20,5		•	•	•	
142125104				1000	±140	21,5		•	•	•	
142130144	0-3000	0-120"	0,01	400	±100	24,0		•	•	•	
142130164				600	±110	24,5		•	•	•	
142130104				1000	±160	25,5	•	•	•		
142135144	0-3500	0-140"	0,01	400	±120	26,5	•	•	•		
142135164				600	±160	27,0	•	•	•		
142135104				1000	±240	28,0	•	•	•		

**OPTIONAL ACCESSORIES**

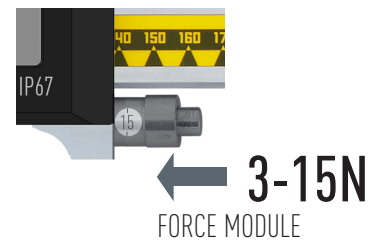

- Extra Long jaw digital caliper with waterproof IP67 Swiss electronics in Al case
- Jaw length up to 1000m
- Aluminium construction with precision linear guides
- **3 MODES DATA TRANSFER:** WIRELESS to MDS app (Windows, Android, iOS, MacOS); WIRELESS HID, WIRELESS HID+MAC
- Calibration certificate included (ISO17025 (Ilac MRA))

**IP67** **SWISS ELECTRONICS**

WIRELESS TO MDS APP  
WIRELESS HID+MAC



**CUSTOM RANGE AND JAWS FOR REQUEST**

Item No	Range		Resol.	Jaws	Accuracy	Weight	Protection	mm/inch	Preset	ABS	WIRELESS	Display	
	mm	inch											mm
142408447	0-800	0-32"	0,001	400	±25	3,9	IP67	•	•	•	•	Big screen Swiss electronics IP67 in Al case	
142408446			0,01		±30	3,9		•	•	•	•		
142411447	0-1000	0-40"	0,001	400	±30	4,3		•	•	•	•		
142411446			0,01		±40	4,3		•	•	•	•		
142411466			600	±50	4,7	•		•	•	•			
142418447	0-1800	0-60"	0,001	400	±40	6,2		Al case	•	•	•		•
142418446			600		±50	6,2			•	•	•		•
142418466			600	±60	6,6	•			•	•	•		
142120146	0-2000	0-80"	0,01	400	±60	17,5			•	•	•		•
142120166				600	±85	18,0			•	•	•		•
142120106				1000	±120	19,0			•	•	•		•
142125146	0-2500	0-100"	0,01	400	±90	20,0			•	•	•		•
142125166				600	±105	20,5	•		•	•	•		
142125106				1000	±140	21,5	•		•	•	•		
142130146	0-3000	0-120"	0,01	400	±100	24,0	•		•	•	•		
142130166				600	±110	24,5	•		•	•	•		
142130106				1000	±160	25,5	•		•	•	•		
142135146	0-3500	0-140"	0,01	400	±120	26,5	•	•	•	•			
142135166				600	±160	27,0	•	•	•	•			
142135106				1000	±240	28,0	•	•	•	•			

### OPTIONAL ACCESSORIES

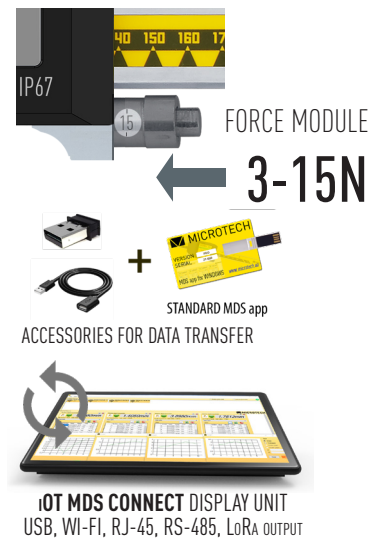

DOWNLOAD APP



- Industry 4.0 adopted Extra long jaw Tablet caliper with computerized MICS system with 2.4" color Touchscreen
- Patents US10184772, UA111194, UA112361, UA121681, UA2022205040
- Functions: On-line Graphic, Analog scale, Go/NoGo, Max/Min, Formula, Timer, Linear correction, Temperature correction
- Measuring HUB: Wireless MICROTECH instrument connection, Synchronization, 2D mode, 2D Graph, Probe mode, Compensation
- Aluminium construction with precision linear guides
- Memory manager: 2000 values, Folders system, Statistics mode, Memory data transfer
- **4 MODES DATA TRANSFER:** WIRELESS to MDS app (Windows, Android, iOS, MacOS); WIRELESS HID, WIRELESS HID+MAC, USB HID
- Calibration certificate included (ISO17025 (Ilac MRA))

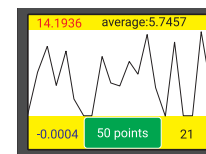

**ON-LINE GRAPHIC MODE**

Item No	Range		Resol.	Jaws	Accu- racy	Weight	Measuring HUB	Analog scale	Graphic	Preset	Go/NoGo	Max/Min	Formula	Timer	Temp comp	Linear corr	Calibr date	Recharge	Memory	WIRELESS	USB HID		
	mm	inch																				mm	mm
142408442	0-800	0-32"	0,01	400	±30	3,9	•	•	•	•	•	•	•	•	•	•	•	•	•	•	•	•	
142411442	0-1000	0-40"		400	±40	4,3	•	•	•	•	•	•	•	•	•	•	•	•	•	•	•	•	
142411462				600	±60	4,7	•	•	•	•	•	•	•	•	•	•	•	•	•	•	•	•	
142418442	0-1800	0-60"		400	±60	6.2	•	•	•	•	•	•	•	•	•	•	•	•	•	•	•	•	•
142418462				600	±80	6,6	•	•	•	•	•	•	•	•	•	•	•	•	•	•	•	•	•

**OPTIONAL ACCESSORIES**

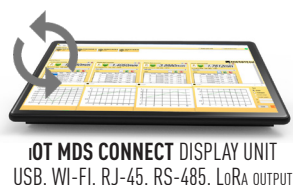

**DOWNLOAD APP**





# TABLET EXTRA LONG JAW CALIPER

- Industry 4.0 adopted Extra long jaw Tablet caliper with computerized MICS system with 2.4" color Touchscreen
- Patents US10184772, UA111194, UA112361, UA121681, UA2022205040
- Functions: On-line Graphic, Analog scale, Go/NoGo, Max/Min, Formula, Timer, Linear correction, Temperature correction
- Measuring HUB: Wireless MICROTECH instrument connection, Synchronization, 2D mode, 2D Graph, Probe mode, Compensation
- Aluminium construction with precision linear guides
- Memory manager: 2000 values, Folders system, Statistics mode, Memory data transfer
- **4 MODES DATA TRANSFER:** WIRELESS to MDS app (Windows, Android, iOS, MacOS); WIRELESS HID, WIRELESS HID+MAC, USB HID
- Calibration certificate included (ISO17025 (Ilac MRA))

WIRELESS TO MDS APP  
WIRELESS HID+MAC  
USB HID

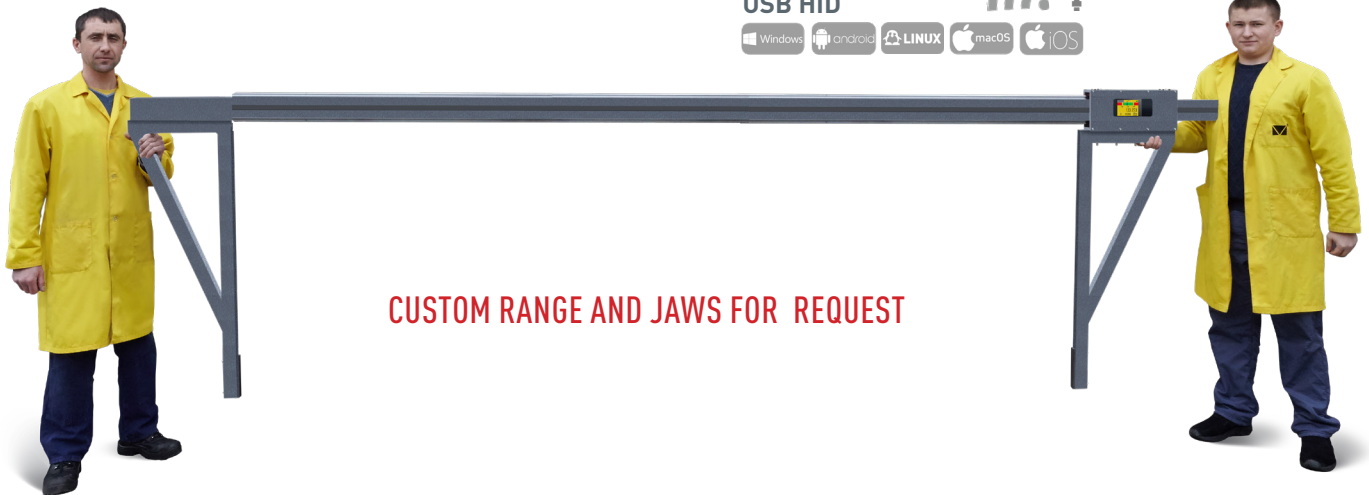

CUSTOM RANGE AND JAWS FOR REQUEST

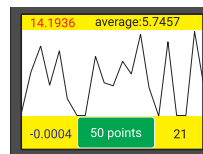

ON-LINE GRAPHIC MODE

Item No	Range		Resol.	Jaws	Accu- racy	Weight	Measuring HUB	Analog scale	Graphic	Preset	Go/NoGo	Max/Min	Formula	Timer	Temp comp	Linear corr	Calibr date	Recharge	Memory	WIRELESS	USB HID										
	mm	inch																				mm	mm	µm	kg						
142120142	0-2000	0-80"	0.01	400	±60	17,5	•	•	•	•	•	•	•	•	•	•	•	•	Folders / 2000 val Long range / HID	•	•										
142120162				600	±85	18,0	•	•	•	•	•	•	•	•	•	•	•	•				•									
142120102				1000	±120	19,0	•	•	•	•	•	•	•	•	•	•	•	•				•									
142125142	0-2500	0-100"		400	±90	20,0	•	•	•	•	•	•	•	•	•	•	•	•				•	Folders / 2000 val Long range / HID	•	•						
142125162				600	±105	20,5	•	•	•	•	•	•	•	•	•	•	•	•				•									
142125102				1000	±140	21,5	•	•	•	•	•	•	•	•	•	•	•	•				•									
142130142	0-3000	0-120"		400	±100	24,0	•	•	•	•	•	•	•	•	•	•	•	•				•				Folders / 2000 val Long range / HID	•	•			
142130162				600	±110	24,5	•	•	•	•	•	•	•	•	•	•	•	•				•									
142130102				1000	±160	25,5	•	•	•	•	•	•	•	•	•	•	•	•				•									
142135142	0-3500	0-140"		400	±120	26,5	•	•	•	•	•	•	•	•	•	•	•	•				•							Folders / 2000 val Long range / HID	•	•
142135162				600	±160	27,0	•	•	•	•	•	•	•	•	•	•	•	•				•									
142135102				1000	±240	28,0	•	•	•	•	•	•	•	•	•	•	•	•				•									

## OPTIONAL ACCESSORIES

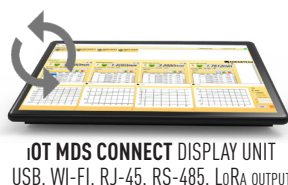

## DOWNLOAD APP



- Universal caliper with 3 pairs of measuring jaws for 5 types of measuring (internal & external point, groove, offset centerline)
- Digital IP54 or Waterproof **IP67** Swiss electronics with 0.01 or 0.001mm resolution
- **3 MODES DATA TRANSFER**: WIRELESS to MDS app (Windows, Android, iOS, MacOS); WIRELESS HID, WIRELESS HID+MAC
- Calibration certificate included (ISO17025 (Iac MRA))



Item No	Range		Reso- lution	Accu- racy	Anvils set			Depth	Force	Protection	Preset	Linear corr	WIRELESS	USB
	mm	inch	mm	µm	inside & outside groove	inside & outside point	disk D	mm	N					
<b>UNIVERSAL DIGITAL CALIPER IP54</b>														
141630151	0-150	0-6"	0,01	±30	5	D3x5	30	40	-	IP54	•			•
141630201	0-200	0-8"			8	D3x8	42	50			•		•	
141630301	0-300	0-12"			±40	10	D3x10	50			60	•		•
<b>UNIVERSAL DIGITAL CALIPER IP67</b>														
141630153	0-150	0-6"	0,01	±30	5	D3x5	30	40	-	IP67	•	•		
141630203	0-200	0-8"			8	D3x8	42	50			•	•		
141630303	0-300	0-12"			±40	10	D3x10	50			60	•	•	
<b>UNIVERSAL WIRELESS CALIPER IP67</b>														
141630154	0-150	0-6"	0,01	±30	5	D3x5	30	40	-	IP67	•	•	•	
141630204	0-200	0-8"			8	D3x8	42	50			•	•	•	
141630304	0-300	0-12"			±40	10	D3x10	50			60	•	•	•
<b>UNIVERSAL MICRON FORCE DIGITAL CALIPER IP67</b>														
141630156	0-150	0-6"	0,001	±15	5	D3x5	30	40	8/4	IP67	•	•		
141630206	0-200	0-8"			±20	8	D3x8	42			50	•	•	
141630306	0-300	0-12"			±25	10	D3x10	50			60	•	•	
<b>UNIVERSAL MICRON WIRELESS FORCE DIGITAL CALIPER IP67</b>														
141630155	0-150	0-6"	0,001	±15	5	D3x5	30	40	8/4	IP67	•	•	•	
141630205	0-200	0-8"			±20	8	D3x8	42			50	•	•	•
141630305	0-300	0-12"			±25	10	D3x10	50			60	•	•	•

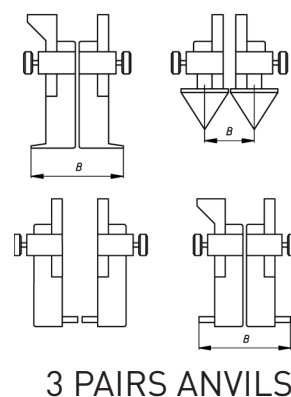

DOWNLOAD APP



- Universal caliper with 3 pairs of measuring jaws for 5 types of measuring (internal & external point, groove, offset centerline)
- Computerized **EINK** or **MICS** indication system Modifications with 0.005 or 0.001 mm resolution
- **3 MODES DATA TRANSFER**: WIRELESS to MDS app (Windows, Android, iOS, MacOS); WIRELESS HID, WIRELESS HID+MAC
- Calibration certificate included (ISO17025 (Ilac MRA))

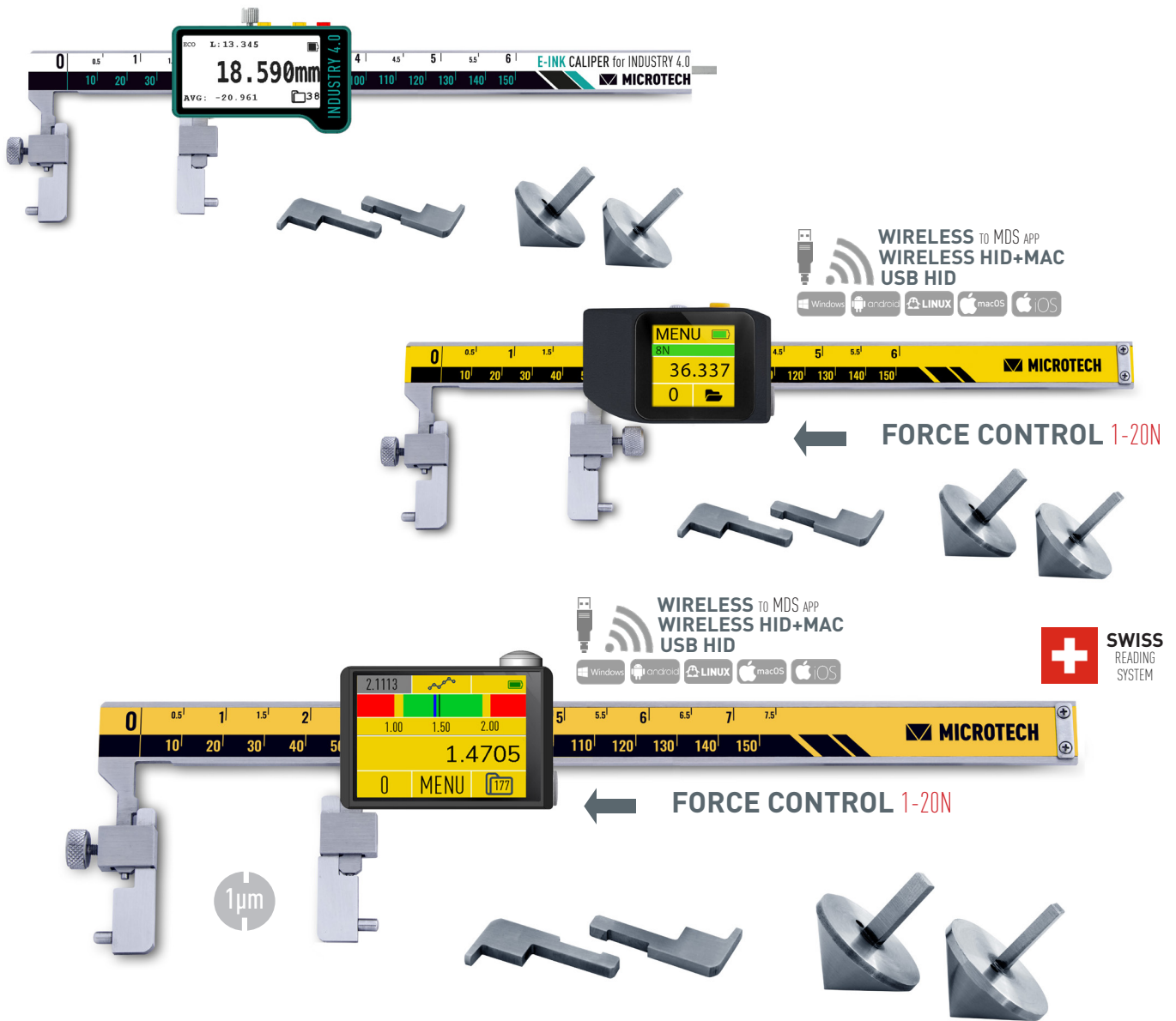

Item No	Range		Resolution	Accuracy	Anvils set			Depth	Force	Protection	Measuring HUB	Analog scale	Graphic	Preset	Go/NoGo	Max/Min	Formula	Timer	Temp comp	Linear corr	Calibr date	Recharge	Memory	WIRELESS	USB
	mm	inch			mm	µm	inside & outside groove																		
<b>UNIVERSAL EINK CALIPER</b>																									
141630159	0-150	0-6"	0,005	±20	5	D3x5	30	40	-	IP54				•	•	•	•	•	•	•	•	•	•	•	
141630209	0-200	0-8"			8	D3x8	42	50																	
141630309	0-300	0-12"			±30	10	D3x10	50																	60
<b>UNIVERSAL COMPUTERIZED CALIPER</b>																									
141630157	0-150	0-6"	0,005	±20	5	D3x5	30	40	1-20	IP54				•	•	•	•	•	•	•	•	•	•	•	
141630207	0-200	0-8"			±25	8	D3x8	42																	50
141630307	0-300	0-12"			±25	10	D3x10	50																	60
<b>UNIVERSAL MICRON COMPUTERIZED CALIPER</b>																									
141630158	0-150	0-6"	0,001	±15	5	D3x5	30	40	1-20	IP54	•	•	•	•	•	•	•	•	•	•	•	•	•	•	
141630208	0-200	0-8"			±20	8	D3x8	42																	50
141630308	0-300	0-12"			±25	10	D3x10	50																	60

- Interchangeable point caliper with 4 pairs of anvils for internal & external measurements
- Digital IP54 or Waterproof IP67 Swiss electronics with 0.01 or 0.001mm resolution
- **3 MODES DATA TRANSFER:** WIRELESS to MDS app (Windows, Android, iOS, MacOS); WIRELESS HID, WIRELESS HID+MAC
- Calibration certificate included (ISO17025 (Ilac MRA))

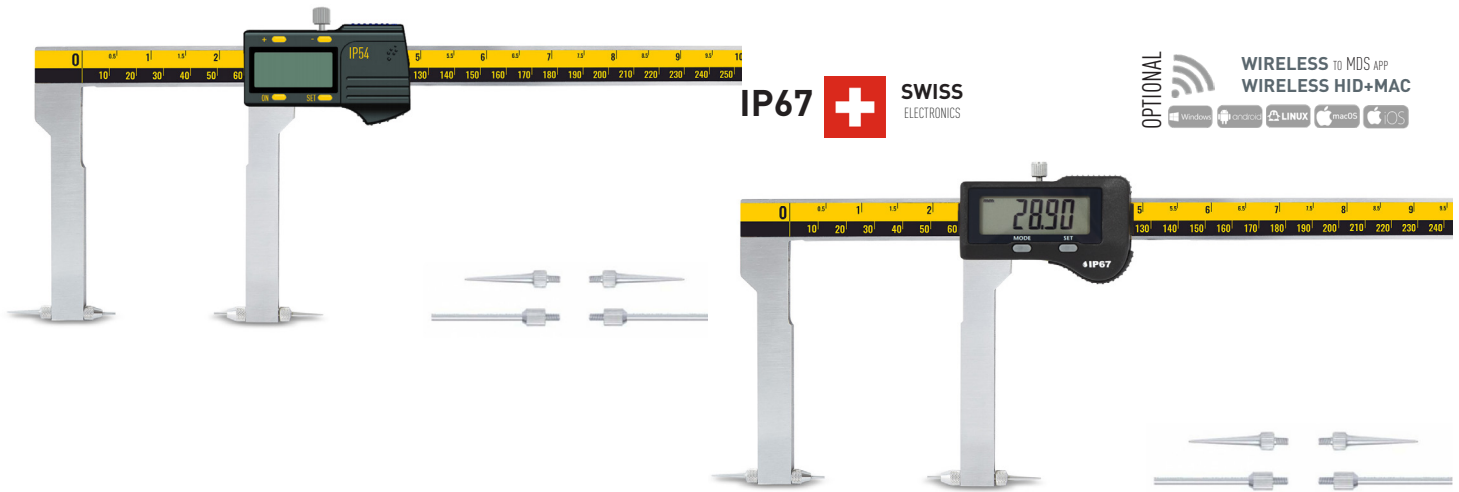

IP67  SWISS ELECTRONICS

OPTIONAL  WIRELESS TO MDS APP  
WIRELESS HID+MAC  



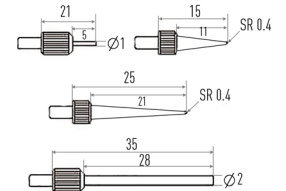

**DOUBLE FORCE**  
EXT 8N INT 4N

IP67  SWISS ELECTRONICS

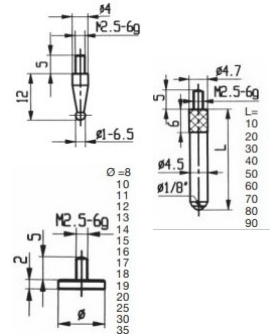

4 PAIR ANVILS



OPTIONAL ANVILS

Item No	Range		Depth	Reso- lution	Accu- racy	Anvils	Force	Protection	Preset	Go/NoGo	Max/Min	Formula	Timer	Temp comp	Linear corr	Calibr date	Recharge	Memory	WIRELESS	USB
	mm	inch																		
<b>INTERCHANGEABLE ANVIL DIGITAL CALIPER IP54</b>																				
141650301	0-300	0-12"	90	0.01	±40	4 pairs	-	IP54	•											•
141650501	0-500	0-20"	150		±50				•											
<b>INTERCHANGEABLE ANVIL DIGITAL CALIPER IP67</b>																				
141650303	0-300	0-12"	90	0.01	±40	4 pairs	-	IP67	•											
141650503	0-500	0-20"	150		±50				•											
<b>INTERCHANGEABLE ANVIL WIRELESS CALIPER IP67</b>																				
141650304	0-300	0-12"	90	0.01	±40	4 pairs	-	IP67	•											•
141650504	0-500	0-20"	150		±50				•											
<b>INTERCHANGEABLE ANVIL MICRON FORCE DIGITAL CALIPER IP67</b>																				
141650306	0-300	0-12"	90	0,001	±25	4 pairs	8/4	IP67	•											
141650506	0-500	0-20"	150		±30				•											
<b>INTERCHANGEABLE ANVIL WIRELESS MICRON FORCE DIGITAL CALIPER IP67</b>																				
141650305	0-300	0-12"	90	0,001	±25	4 pairs	8/4	IP67	•											•
141650505	0-500	0-20"	150		±30				•											

DOWNLOAD APP



- Interchangeable point caliper with 4 pairs of anvils for internal & external measurements
- Computerized **EINK** or **MICS** indication system Modifications with 0.005 or 0.001mm resolution
- **3 MODES DATA TRANSFER:** **WIRELESS** to MDS app (Windows, Android, iOS, MacOS); **WIRELESS HID, WIRELESS HID+MAC**
- **Calibration** certificate included (ISO17025 (Ilac MRA))

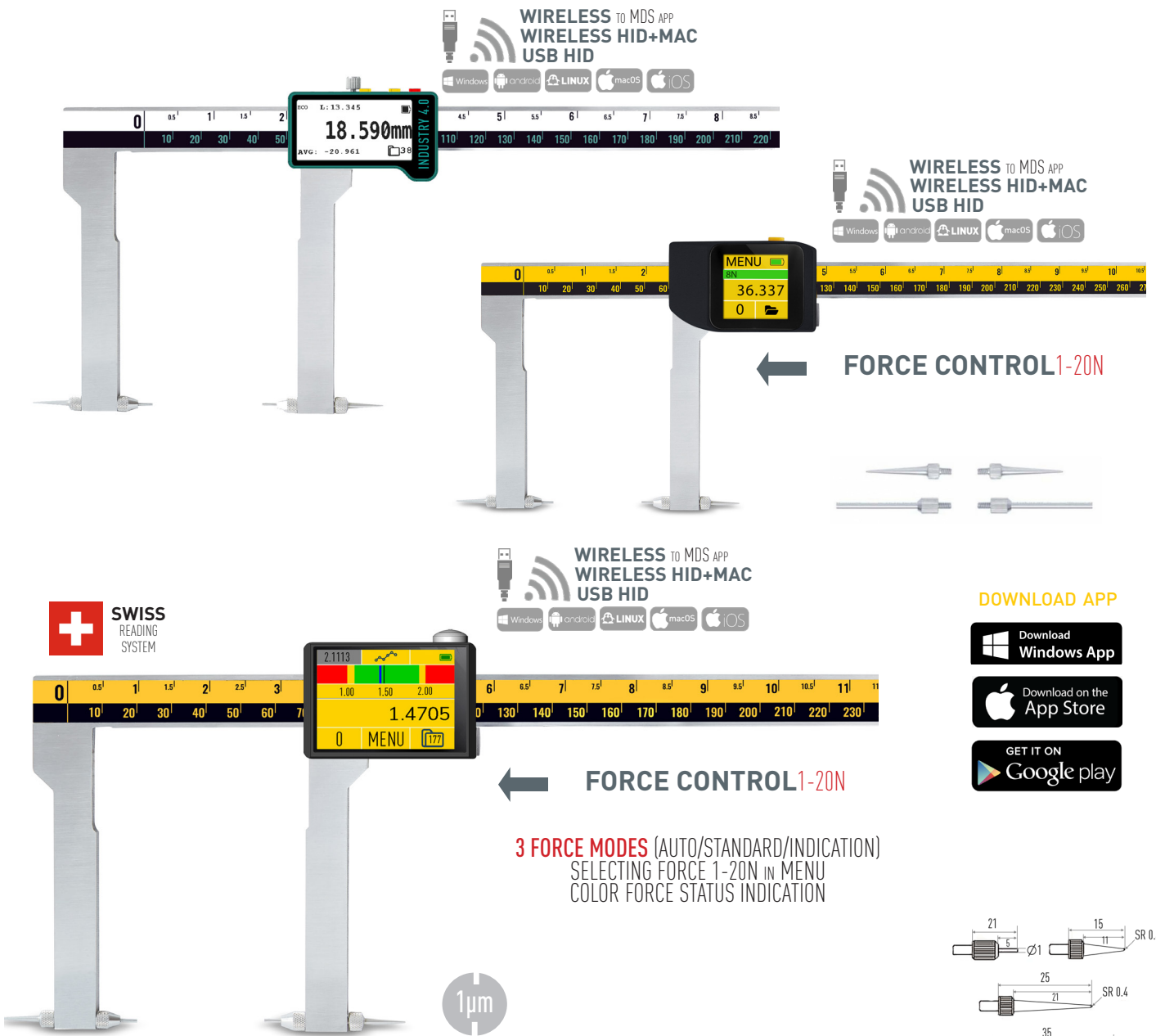

DOWNLOAD APP



**3 FORCE MODES** (AUTO/STANDARD/INDICATION)  
SELECTING FORCE 1-20N IN MENU  
COLOR FORCE STATUS INDICATION

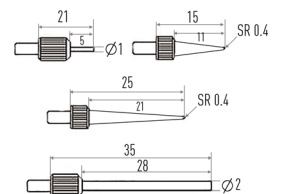

4 PAIR ANVILS

Item No	Range		Depth	Reso- lution	Accu- racy	Anvils	Force	Protection	Preset	Go/NoGo	Max/Min	Formula	Timer	Temp comp	Linear corr	Calibr date	Recharge	Memory	WIRELESS	USB
	mm	inch																		
<b>INTERCHANGEABLE ANVIL EINK CALIPER IP54</b>																				
141650309	0-300	0-12"	90	0,005	±25			IP54	•	•	•	•	•	•	•	•	•	•		•
<b>INTERCHANGEABLE ANVIL COMPUTERIZED CALIPER IP54</b>																				
141650307	0-300	0-12"	90	0,005	±25			IP54	•	•	•	•	•	•	•	•	•	•		•
141650507	0-500	0-20"	150	0,01	±30	4 pairs	1-20	IP54	•	•	•	•	•	•	•	•	•	•	Folders / 2000 val	•
<b>INTERCHANGEABLE ANVIL MICRON COMPUTERIZED CALIPER IP54</b>																				
141650308	0-300	0-12"	90	0,001	±25	4 pairs	1-20	IP54	•	•	•	•	•	•	•	•	•	•		•
141650508	0-500	0-20"	150		±30	4 pairs	1-20	IP54	•	•	•	•	•	•	•	•	•	•	Long range / HID	•

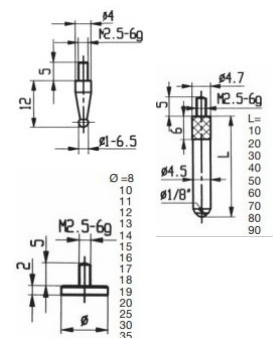

OPTIONAL ANVILS

- Outside groove caliper with flat points
- Digital IP54 or Waterproof IP67 Swiss electronics with 0.01 or 0.001mm resolution
- **3 MODES DATA TRANSFER:** WIRELESS to MDS app (Windows, Android, iOS, MacOS); WIRELESS HID, WIRELESS HID+MAC
- Calibration certificate included (ISO17025 (Ilac MRA))



Item No	Range		Reso- lution	Accu- racy	Force	Protection	Preset	Go/NoGo	Max/Min	Formula	Timer	Temp comp	Linear corr	Calibr date	Recharge	Memory	WIRELESS	USB HID
	mm	inch	mm	µm	N													
<b>OUTSIDE GROOVE DIGITAL CALIPER IP54</b>																		
141430150	0-150	0-6"		±30														•
141430200	0-200	0-8"	0,01	±30	-	IP54												•
141430300	0-300	0-12"		±30														•
<b>OUTSIDE GROOVE DIGITAL CALIPER IP67</b>																		
141430153	0-150	0-6"		±30			•											•
141430203	0-200	0-8"	0,01	±30	-	IP67	•											•
141430303	0-300	0-12"		±30			•											•
<b>OUTSIDE GROOVE WIRELESS CALIPER IP67</b>																		
141430154	0-150	0-6"		±30			•											•
141430204	0-200	0-8"	0,01	±30	-	IP67	•											•
141430304	0-300	0-12"		±30			•											•
<b>OUTSIDE GROOVE MICRON FORCE DIGITAL CALIPER IP67</b>																		
141430156	0-150	0-6"		±10			•											•
141430206	0-200	0-8"	0,001	±15	8/4	IP67	•											•
141430306	0-300	0-12"		±20			•											•
<b>OUTSIDE GROOVE WIRELESS MICRON FORCE DIGITAL CALIPER IP67</b>																		
141430155	0-150	0-6"		±10			•											•
141430205	0-200	0-8"	0,001	±15	8/4	IP67	•											•
141430305	0-300	0-12"		±20			•											•

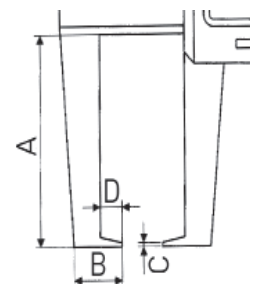
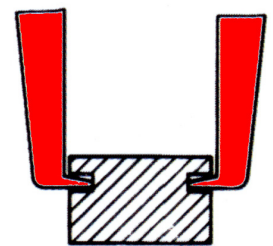

	A	B	C	D
mm	mm	mm	mm	mm
0-150	25	9	1	5
0-200	25	9	1.5	8
0-300	43	16	1.5	8

- Outside groove caliper with flat points
- Computerized **EINK** or **MICS** indication system Modifications with 0.005 or 0.001mm resolution
- **3 MODES DATA TRANSFER:** **WIRELESS** to MDS app (Windows, Android, iOS, MacOS); **WIRELESS HID, WIRELESS HID+MAC**
- Calibration certificate included (ISO17025 (Ilac MRA))

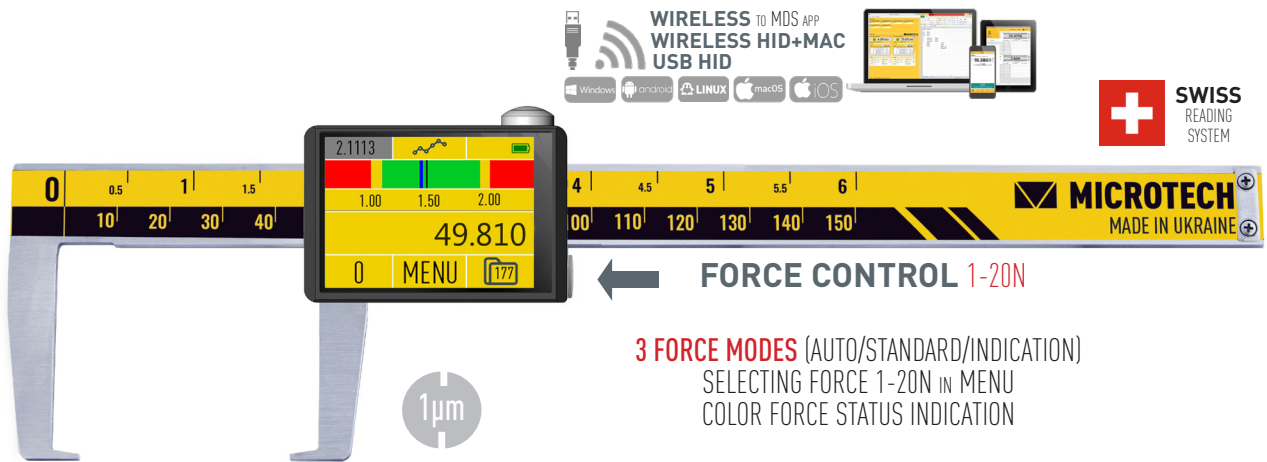
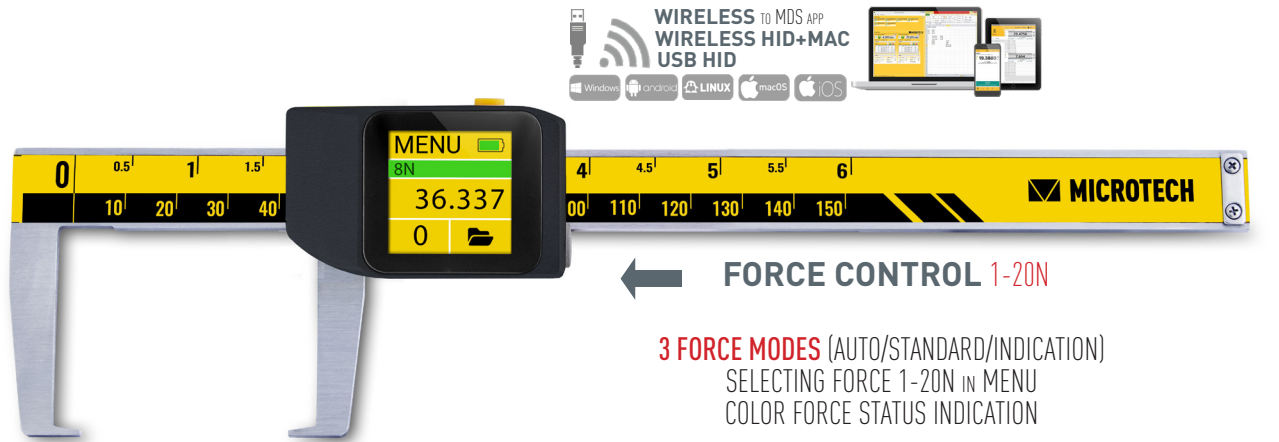

**ON-LINE GRAPHIC MODE**

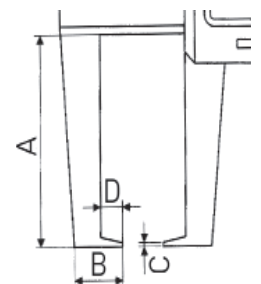
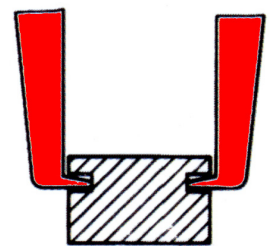
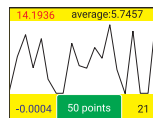

Item No	Range		Reso- lution	Accu- racy	Force	Protection	Preset	Go/NoGo	Max/Min	Formula	Timer	Temp comp	Linear corr	Calibr date	Recharge	Memory	WIRELESS	USB HID	
	mm	inch	mm	µm	N														
<b>OUTSIDE GROOVE COMPUTERIZED CALIPER IP54</b>																			
141430157	0-150	0-6"		±20			•	•	•	•	•	•	•	•	•	•	•	•	•
141430207	0-200	0-8"	0,005	±25	1-20	IP54	•	•	•	•	•	•	•	•	•	•	•	•	•
141430307	0-300	0-12"		±25			•	•	•	•	•	•	•	•	•	•	•	•	•
<b>OUTSIDE GROOVE MICRON COMPUTERIZED CALIPER IP54</b>																			
141430158	0-150	0-6"		±10			•	•	•	•	•	•	•	•	•	•	•	•	•
141430208	0-200	0-8"	0,001	±15	1-20	IP54	•	•	•	•	•	•	•	•	•	•	•	•	•
141430308	0-300	0-12"		±20			•	•	•	•	•	•	•	•	•	•	•	•	•

	A	B	C	D
mm	mm	mm	mm	mm
0-150	25	9	1	5
0-200	25	9	1.5	8
0-300	43	16	1.5	8

- Digital Outside point caliper with or without FORCE control
- Digital Waterproof IP67 Swiss electronics with 0.01 or 0.001mm resolution
- **3 MODES DATA TRANSFER:** WIRELESS to MDS app (Windows, Android, iOS, MacOS); WIRELESS HID, WIRELESS HID+MAC
- Calibration certificate included (ISO17025 (Ilac MRA))



**IP67**  
 **SWISS**  
 ELECTRONICS

Item No	Range		Resolu- tion	Jaws		Accu- racy	Force	Protection	Preset	Linear corr	WIRELESS
	mm	inch		Depth	D point						
<b>OUTSIDE POINT DIGITAL CALIPER IP67</b>											
141403143	0-300	0-12"	0,01	90	1	±30	12	IP67	•	•	•
141405143	0-500	0-20"		150	1	±40			•	•	•
141405153				300	3	±70			•	•	•
141410153	0-1000	0-40"							•	•	•
<b>WIRELESS OUTSIDE POINT WIRELESS CALIPER IP67</b>											
141403144	0-300	0-12"	0,01	90	1	±30	12	IP67	•	•	•
141405144	0-500	0-20"		150	1	±40			•	•	•
141405154				300	3	±70			•	•	•
141410154	0-1000	0-40"							•	•	•
<b>OUTSIDE POINT MICRON FORCE DIGITAL CALIPER IP67</b>											
141403145	0-300	0-12"	0,001	90	1	±15	12	IP67	•	•	•
141405145	0-500	0-20"		150	1	±25			•	•	•
141405155				300	3	±40			•	•	•
141410155	0-1000	0-40"							•	•	•
<b>OUTSIDE POINT WIRELESS MICRON FORCE DIGITAL CALIPER IP67</b>											
141403147	0-300	0-12"	0,001	90	1	±15	12	IP67	•	•	•
141405147	0-500	0-20"		150	1	±25			•	•	•
141405157				300	3	±40			•	•	•
141410157	0-1000	0-40"							•	•	•

CUSTOM RANGE AND JAWS FOR REQUEST

OPTIONAL ACCESSORIES

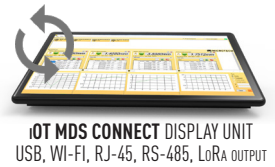

DOWNLOAD APP





- Computerized Outside point caliper with e-Force control 1-20N
- Computerized **MICS** indication system Modifications with 0.01 or 0.001mm resolution
- **3 MODES DATA TRANSFER**: WIRELESS to MDS app (Windows, Android, iOS, MacOS); WIRELESS HID, WIRELESS HID+MAC
- Calibration certificate included (ISO17025 (Ilac MRA))

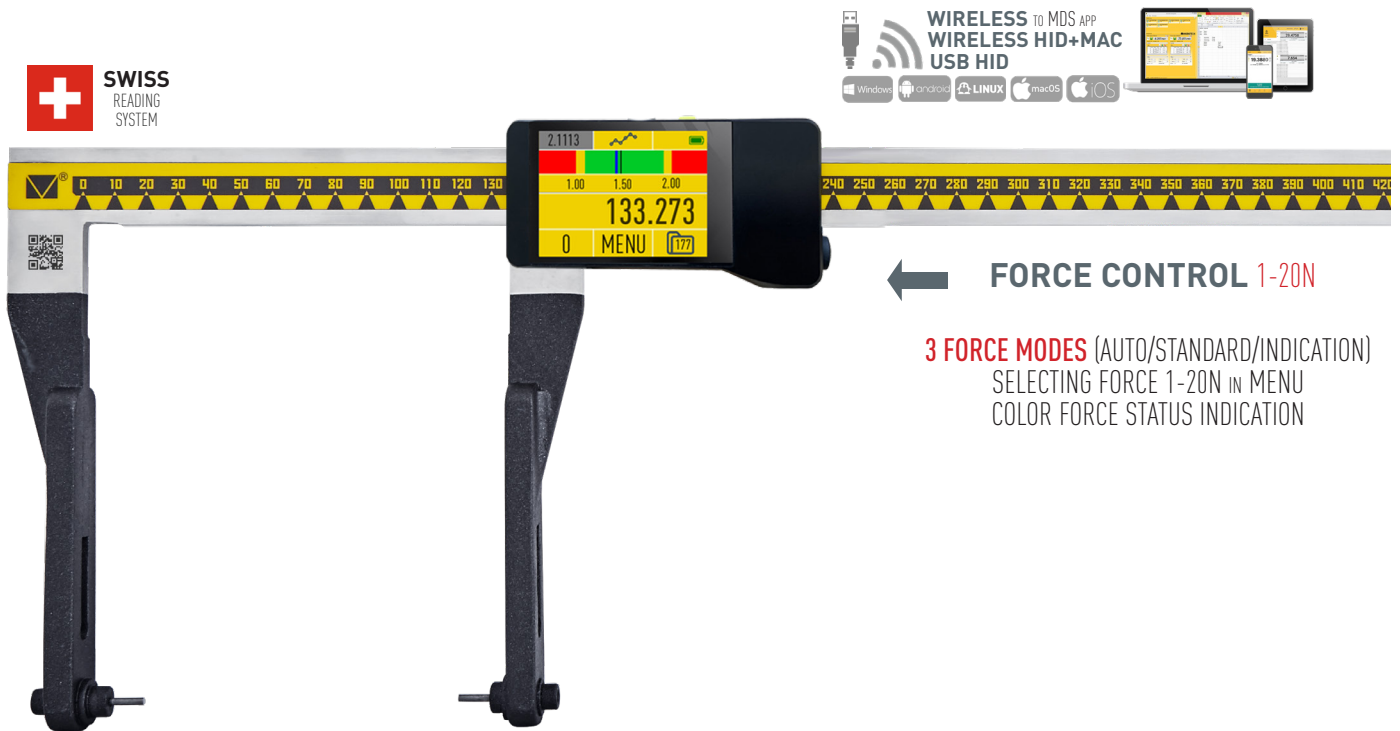

**FORCE CONTROL 1-20N**

**3 FORCE MODES** (AUTO/STANDARD/INDICATION)  
SELECTING FORCE 1-20N IN MENU  
COLOR FORCE STATUS INDICATION

1µm

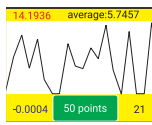

**ON-LINE GRAPHIC MODE**

**OPTIONAL ACCESSORIES**

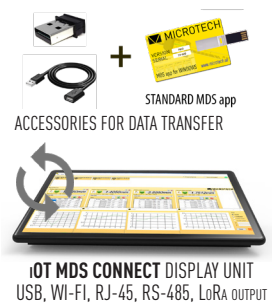

Item No	Range		Resolu- tion	Jaws		Accu- racy	Force	Protection	Measuring HUB	Analog scale	Graphic	Preset	Go/NoGo	Max/Min	Formula	Timer	Temp comp	Linear corr	Calibr date	Recharge	Memory	WIRELESS	USB HID		
	mm	inch		Depth	D point																			µm	N
<b>OUTSIDE POINT COMPUTERIZED CALIPER IP54</b>																									
141403146	0-300	0-12"	0.005	90	1	±25																			
141405146	0-500	0-20"	0,01	150	1	±40	1-20	IP54																	
141405156				300	3																				
141410156	0-1000	0-40"		300	3	±60																			
<b>OUTSIDE POINT COMPUTERIZED CALIPER IP54</b>																									
141403148	0-300	0-12"	0,001	90	1	±15	1-20	IP54																	
141405148	0-500	0-20"		150	1	±25																			
141405158				300	3																				
141410158	0-1000	0-40"			300	3			±40																

- Inside groove caliper with Double internal jaws (30+70mm)
- Digital IP54 or Waterproof IP67 Swiss electronics with 0.01 or 0.001mm resolution
- **3 MODES DATA TRANSFER:** WIRELESS to MDS app (Windows, Android, iOS, MacOS); WIRELESS HID, WIRELESS HID+MAC
- Calibration certificate included (ISO17025 (Ilac MRA))

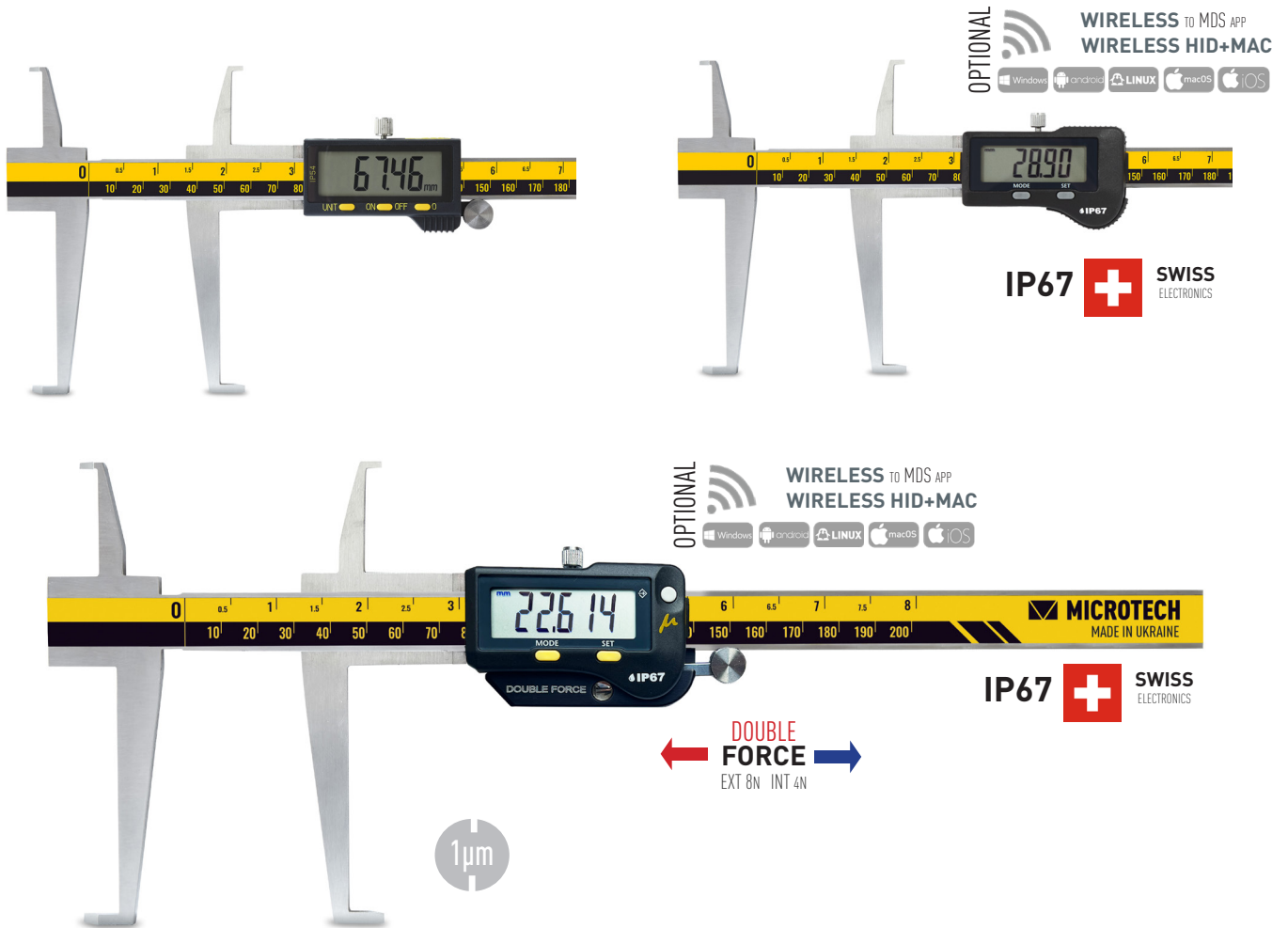

Item No	Range				Jaws		Pins		Reso- lution	Accu- racy	FORCE	Protection	Preset	WIRELESS	USB HID
	upper		lower		upper	lower	upper	lower							
	mm	inch	mm	inch	mm	mm	mm	mm							
<b>INSIDE GROOVE DIGITAL CALIPER IP54</b>															
141220200	9-200	0.4-8"	17-200	0,7-8"	30	70	3,5x1,5	8,5x2,5	0,01	±30		IP54			•
141220300	9-300	0.4-12"	17-300	0,7-12"						±40					•
<b>INSIDE GROOVE DIGITAL CALIPER IP67</b>															
141220203	9-200	0.4-8"	17-200	0,7-8"	30	70	3,5x1,5	8,5x2,5	0,01	±30		IP67	•		
141220303	9-300	0.4-12"	17-300	0,7-12"						±40			•		
<b>INSIDE GROOVE WIRELESS CALIPER IP67</b>															
141220204	9-200	0.4-8"	17-200	0,7-8"	30	70	3,5x1,5	8,5x2,5	0,01	±30		IP67	•	•	
141220304	9-300	0.4-12"	17-300	0,7-12"						±40			•	•	
<b>INSIDE GROOVE MICRON FORCE CALIPER IP67</b>															
141220206	9-200	0.4-8"	17-200	0,7-8"	30	70	3,5x1,5	8,5x2,5	0,001	±20	8/4	IP67	•		
141220306	9-300	0.4-12"	17-300	0,7-12"						±25			•		
<b>INSIDE GROOVE WIRELESS MICRON FORCE CALIPER IP67</b>															
141220205	9-200	0.4-8"	17-200	0,7-8"	30	70	3,5x1,5	8,5x2,5	0,001	±20	8/4	IP67	•	•	
141220305	9-300	0.4-12"	17-300	0,7-12"						±25			•	•	

DOWNLOAD APP



- Inside groove caliper with Double internal jaws (30+70mm)
- Computerized **EINK** or **MICS** indication system Modifications with 0.005 or 0.001mm resolution
- **3 MODES DATA TRANSFER:** WIRELESS to MDS app (Windows, Android, iOS, MacOS); WIRELESS HID, WIRELESS HID+MAC
- Calibration certificate included (ISO17025 (Ilac MRA))

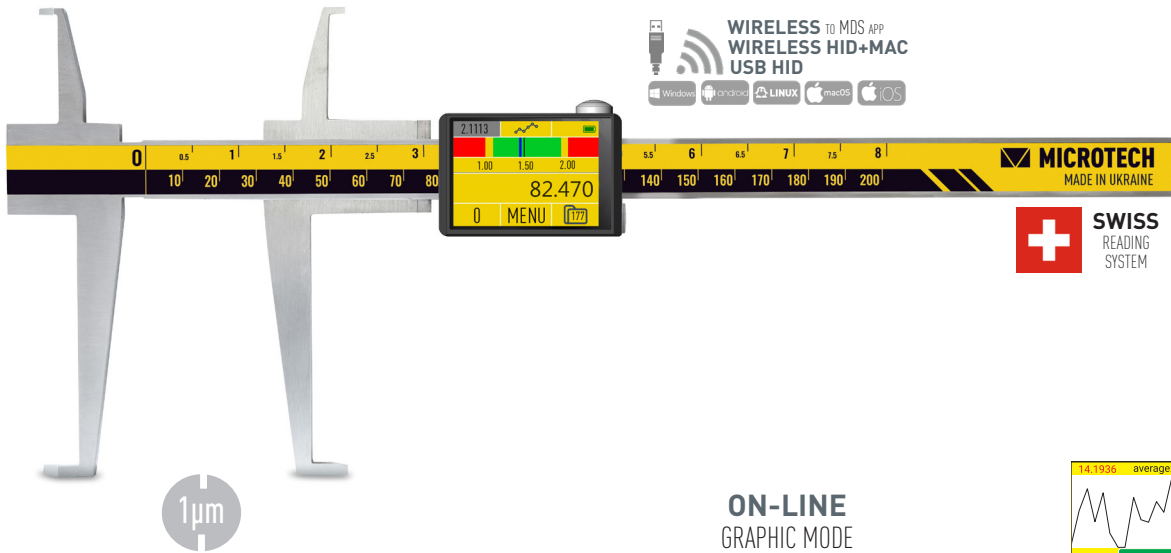
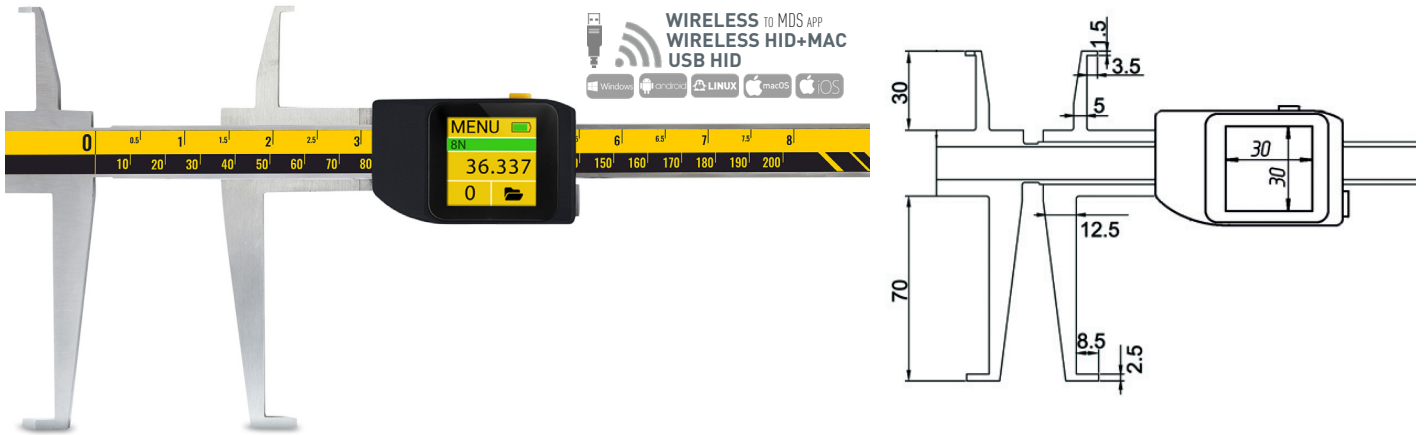

ON-LINE GRAPHIC MODE

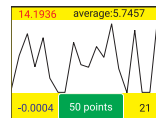

Item No	Range				Jaws		Pins		Reso- lution	Accu- racy	FORCE	Protection	Preset	Go/NoGo	Max/Min	Formula	Timer	Temp comp	Calibr date	Memory	WIRELESS	USB HID
	upper		lower		upper	lower	upper	lower														
	mm	inch	mm	inch	mm	mm	mm	mm														
<b>INSIDE GROOVE COMPUTERIZED CALIPER IP54</b>																						
141220207	9-200	0.4-8"	17-200	0,7-8"	30	70	3,5x1,5	8,5x2,5	0,005	±20	-	IP54	•	•	•	•	•	•	•	•	•	•
141220307	9-300	0.4-12"	17-300	0,7-12"						±25			•	•	•	•	•	•	•	•	•	
<b>INSIDE GROOVE COMPUTERIZED CALIPER IP54</b>																						
141220208	9-200	0.4-8"	17-200	0,7-8"	30	70	3,5x1,5	8,5x2,5	0,001	±20	-	IP54	•	•	•	•	•	•	•	•	•	•
141220308	9-300	0.4-12"	17-300	0,7-12"						±25			•	•	•	•	•	•	•	•	•	•

## OPTIONAL ACCESSORIES

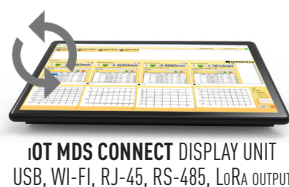

## DOWNLOAD APP



- Inside point caliper
- Digital IP67 or Computerized MICS indication system Modification with Long range Wireless, Wireless HID or USB HID data transfer to Windows, Android, iOS, macOS, Linux systems direct to any app.
- Calibration certificate included (ISO17025 (Ilac MRA))



**CUSTOM RANGE AND JAWS FOR REQUEST**

Item No	Range		Resolu- tion	Jaws		Accu- racy	Measuring HUB	Analog scale	line Graphic	Preset	Go/NoGo	Max/Min	Formula	Timer	Temp comp	Linear corr	Calibr date	Recharge	Memory	WIRELESS	USB HID	
	mm	inch		Depth	D point																	mm
<b>INSIDE POINT DIGITAL CALIPER IP67</b>																						
141305143	42-542	1.7-22"	0,01	150	1	±50				•												
141305153	75-575	3-23"		300	3						•											
141310153	85-1000	4-44"					±80				•											
<b>INSIDE POINT WIRELESS CALIPER IP67</b>																						
141305144	42-542	1.7-22"	0,01	150	1	±50				•											•	
141305154	75-575	3-23"		300	3						•											
141310154	85-1000	4-44"					±80				•											
<b>INSIDE POINT COMPUTERIZED CALIPER IP54</b>																						
141305146	42-52	1.7-22"	0,01	150	1	±40	•	•	•	•	•	•	•	•	•	•	•	•	•	•	•	
141305156	75-575	3-23"		300	3			•	•	•	•	•	•	•	•	•	•	•	•	•	•	•
141310156	85-1085	4-44"					±60	•	•	•	•	•	•	•	•	•	•	•	•	•	•	•

**OPTIONAL ACCESSORIES**

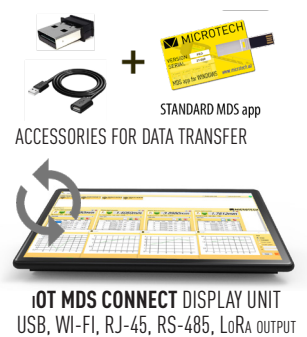

**IoT MDS CONNECT DISPLAY UNIT**  
USB, WI-FI, RJ-45, RS-485, LoRa OUTPUT

**DOWNLOAD APP**



# SMALL GROOVES DIGITAL CALIPER IP67

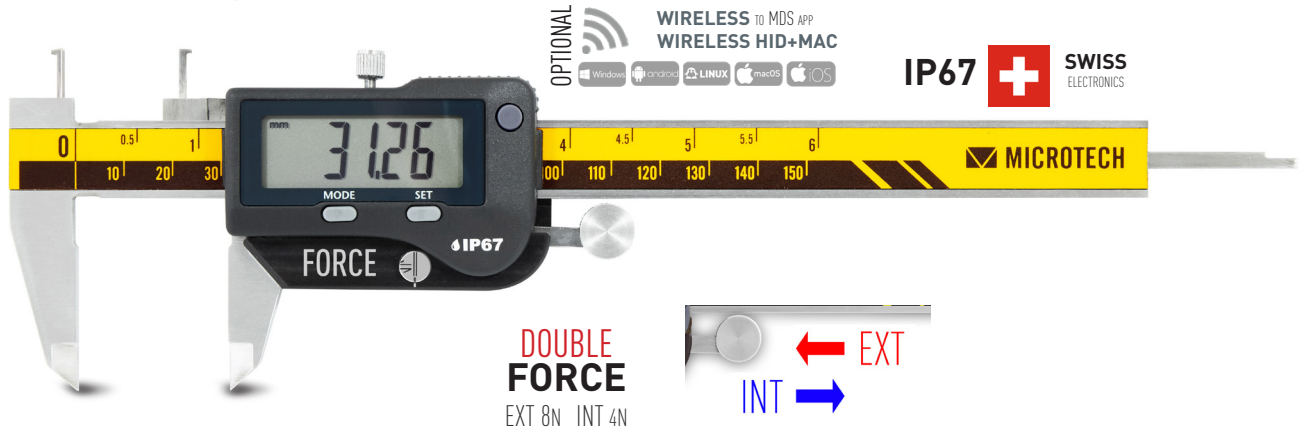
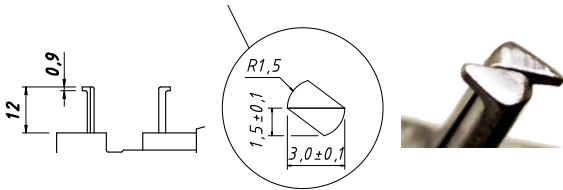

OPTIONAL WIRELESS TO MDS APP WIRELESS HID+MAC  
    

IP67  SWISS ELECTRONICS

Item No	Range				Resolution	Double force	Accuracy	Protection	mm/inch	Preset	Auto on/off	WIRELESS
	External		Internal									
	mm	inch	mm	inch								
141830156					0,001		±15		•	•	•	
141830153	0-150	0-6"	3-150	0,12-6"	0,01	8 ext	±20	IP67	•	•	•	
141830154						4 int	±20		•	•	•	•

DOWNLOAD APP



# FLAT INTERNAL JAWS DIGITAL CALIPER

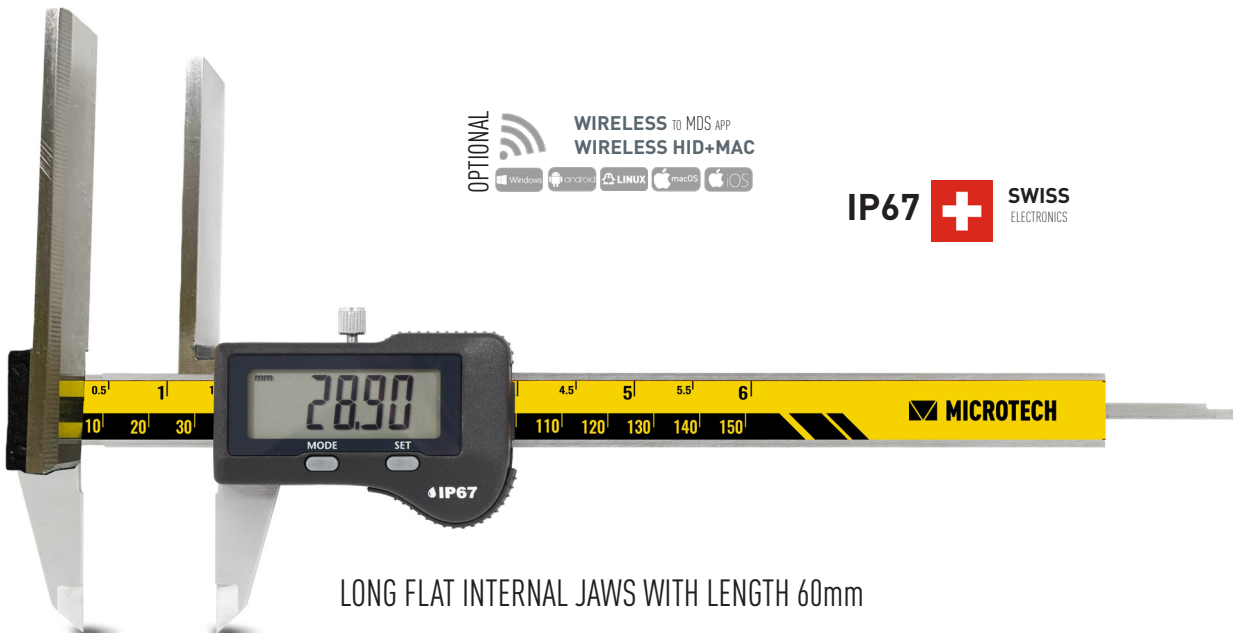

OPTIONAL WIRELESS TO MDS APP WIRELESS HID+MAC  
    

IP67  SWISS ELECTRONICS

Item No	Range		Resolution	Double force	Accuracy	Jaws		Proof	Display	WIRELESS
	mm	inch				External	Internal			
	mm	mm				mm	mm			
141840156			0,001	8/4	±20				Swiss Digit	
141840153	0-150	0-6"	0,01	-	±30	40	60	IP67	height 11mm	
141840154					±30					•

DOWNLOAD APP



- Long internal Jaw calipers (Internal jaw 41.5mm)
- Digital IP54 / IP67 or Computerized **MICS** indication system Modification with Long range Wireless, Wireless HID or USB HID data transfer to Windows, Android, iOS, macOS, Linux systems direct to any app.
- **Calibration** certificate included (ISO17025 (Ilac MRA))



Item No	Range		Reso- lution	Accuracy	Jaws		Protection	mm/inch	Preset	Go/NoGo	Max/Min	Formula	Timer	Temp comp	Linear corr	Calibr date	Recharge	Memory	USB	WIRELESS
	mm	inch			mm	µm														
<b>LONG INTERNAL JAW DIGITAL CALIPER IP54</b>																				
141130151	0-150	0-6"	0,01	±30	40	41.5	IP54	•	•											•
141130301	0-300	0-12"		±40				•	•											
<b>LONG INTERNAL JAW DIGITAL CALIPER IP67</b>																				
141130153	0-150	0-6"	0,01	±30	40	41.5	IP67	•	•											
141130303	0-300	0-12"		±40				•	•											
<b>LONG INTERNAL JAW WIRELESS CALIPER IP67</b>																				
141130154	0-150	0-6"	0,01	±30	40	41.5	IP67	•	•											•
141130304	0-300	0-12"		±40				•	•											
<b>LONG INTERNAL JAW COMPUTERIZED CALIPER</b>																				
141130156	0-150	0-6"	0,005	±20	40	41.5	IP54	•	•	•	•	•	•	•	•	•	•	•	•	•
141130306	0-300	0-12"		±30				•	•	•	•	•	•	•	•	•	•	•	•	•

**OPTIONAL ACCESSORIES**

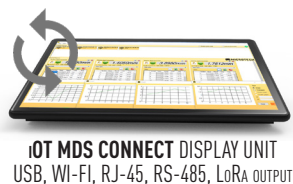

**DOWNLOAD APP**



# KNIFE EDGE INSIDE CALIPER

- Knife edge inside caliper with jaw length 100 or 150 mm
- Digital IP54 / IP67 or Computerized **MICS** indication system Modification with **Long range** Wireless, Wireless HID or USB HID data transfer to Windows, Android, iOS, macOS, Linux systems direct to any app.
- **Calibration** certificate included (ISO17025 (Ilac MRA))



Item No	Range		Resolution	Accuracy	Depth	Protection	Preset	Go/NoGo	Max/Min	Formula	Timer	Temp comp	Linear corr	Calibr date	FW update	Recharge	Memory	WIRELESS	USB	
	mm	inch																		mm
<b>KNIFE EDGE INSIDE DIGITAL CALIPER IP54</b>																				
141210200	22-200	0.8-8"	0,01	±30	100	IP54														•
141210300	22-300	0.8-12"		±50	150															
<b>KNIFE EDGE INSIDE DIGITAL CALIPER IP67</b>																				
141210203	22-200	0.8-8"	0,01	±30	100	IP67	•						•							
141210303	22-300	0.8-12"		±50	150		•							•						
<b>KNIFE EDGE INSIDE WIRELESS CALIPER IP67</b>																				
141210204	22-200	0.8-8"	0,01	±30	100	IP67	•						•							•
141210304	22-300	0.8-12"		±50	150		•							•						
<b>KNIFE EDGE INSIDE COMPUTERIZED CALIPER IP54</b>																				
141210207	22-200	0.8-8"	0,005	±20	100	IP54	•	•	•	•	•	•	•	•	•	•	•	•	•	•
141210307	22-300	0.8-12"		±40	150		•	•	•	•	•	•	•	•	•	•	•	•	•	•

## OPTIONAL ACCESSORIES

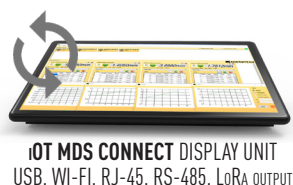

## DOWNLOAD APP



# GEAR TOOTH DIGITAL CALIPER IP54

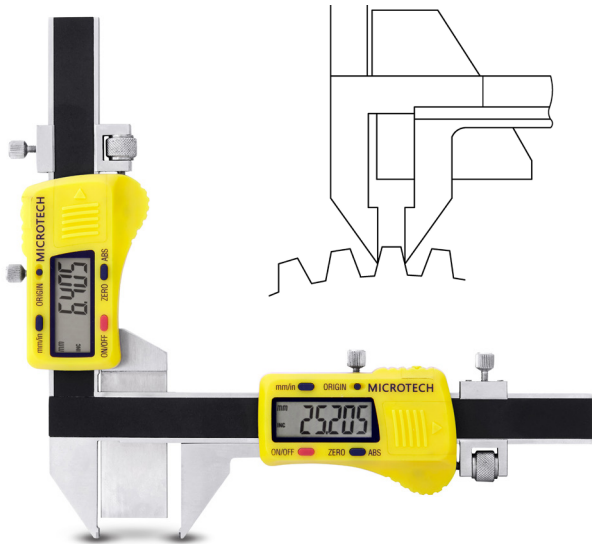

- Gear tooth digital caliper
- Digital IP54 electronics with 0.005mm resolution
- Calibration certificate included (ISO17025 (Ilac MRA))

Item No	Range	Resolution	Proof	Display
	mm	mm		
142022600	M1-25	0,005	IP54	Digit height 9mm
142025000	M5-50			

# MICRON GEAR TOOTH DIGITAL CALIPER IP67



- MICRON Gear tooth digital caliper
- Digital SWISS IP67 electronics with 0.001mm resolution
- Calibration certificate included (ISO17025 (Ilac MRA))

Item No	Range	Resolution	Protection	Preset
	mm	mm		
142022605	M1-25	0,001	IP67	•
142025005	M5-50			

# MICRON WIRELESS GEAR TOOTH DIGITAL CALIPER IP67



Item No	Range	Resolution	Protection	Preset	WIRELESS
	mm	mm			
142022604	M1-25	0,001	IP67	•	•
142025004	M5-50				

DOWNLOAD APP



MADE IN UKRAINE



- OFFSET caliper for measure hard to get dimensions
- Digital IP54 / IP67 or Computerized **MICS** indication system Modification with Long range Wireless, Wireless HID or USB HID data transfer to Windows, Android, iOS, macOS, Linux systems direct to any app.
- **4 MODES DATA TRANSFER:** WIRELESS to MDS app (Windows, Android, iOS, MacOS); WIRELESS HID, WIRELESS HID+MAC, USB HID
- **Calibration** certificate included (ISO17025 (Ilac MRA))



Item No	Range	Jaws		Reso- lution	Accu- racy	Force	Protection	Preset	Go/NoGo	Max/Min	Formula	Timer	Temp comp	Linear corr	Calibr date	FW update	Recharge	Memory	WIRELESS	USB	
		slide	fix																		
	mm	mm	mm	mm	µm	N															
<b>OFFSET DIGITAL CALIPER IP54</b>																					
141740150	0-150	110	40	0,01	±30	IP54															•
141740300	0-300	130	60		±40																
<b>OFFSET DIGITAL CALIPER IP67</b>																					
141740153	0-150	110	40	0,01	±30	IP67	•														
141740303	0-300	130	60		±40			•													
<b>OFFSET WIRELESS CALIPER IP67</b>																					
141740154	0-150	110	40	0,01	±30	IP67	•														•
141740304	0-300	130	60		±40			•													
<b>OFFSET COMPUTERIZED CALIPER IP54</b>																					
141740157	0-150	110	40	0,005	±20	IP54	•	•	•	•	•	•	•	•	•	•	•	•	•	•	•
141740307	0-300	130	60		±30		1-20	•	•	•	•	•	•	•	•	•	•	•	•	•	•

## OPTIONAL ACCESSORIES

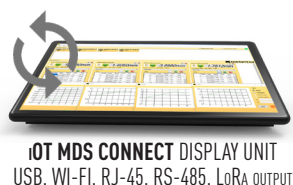

## DOWNLOAD APP



- OFFSET CENTERLINE caliper for hole center distance measurements
- Digital IP54 or IP67 SWISS electronics with PRESET function
- MODIFICATION with **WIRELESS** data transfer **3 MODES DATA TRANSFER**: WIRELESS to MDS app (Windows, Android, iOS, MacOS); WIRELESS HID, WIRELESS HID+MAC
- Calibration certificate included (ISO17025 (Ilac MRA))



**IP67**  **SWISS ELECTRONICS**

Item No	Range		Reso- lution	Accu- racy	Anvil D		Protection	Preset	USB	WIRELESS
	mm	inch			standard	option				
	mm	µm			mm	mm				
<b>OFFSET CENTERLINE DIGITAL CALIPER IP54</b>										
141730151	10-160	0.4-6.4"	0,01	±30	10	20, 35	IP54	•	•	
141730201	10-210	0.4-8.4"						•	•	
141730301	10-310	0.4-12.4"						•	•	
<b>OFFSET CENTERLINE DIGITAL CALIPER IP67</b>										
141730153	10-160	0.4-6.4"	0,01	±30	10	20, 35	IP67	•		
141730203	10-210	0.4-8.4"						•		
141730303	10-310	0.4-12.4"						•		
141730513	20-520	0.8-20.4"		±40	20	35, 50		•		
141731013	20-1020	0.8-40.4"		±50				•		
141731513	20-1520	0.8-40.4"		±60				•		
141732013	20-2020	0.8-60.4"		±70				•		
141733013	20-3020	0.8-80.4"				•				
<b>OFFSET CENTERLINE WIRELESS CALIPER IP67</b>										
141730154	10-160	0.4-6.4"	0,01	±30	10	20, 35	IP67	•		•
141730204	10-210	0.4-8.4"						•		•
141730304	10-310	0.4-12.4"						•		•
141730514	20-520	0.8-20.4"		±40	20	35, 50		•		•
141731014	20-1020	0.8-40.4"		±50				•		•
141731514	20-1520	0.8-40.4"		±60				•		•
141732014	20-2020	0.8-60.4"		±70				•		•
141733014	20-3020	0.8-80.4"				•		•		



**CUSTOM RANGE AND ANVILS FOR REQUEST**

**MADE IN UKRAINE**

# MICRON OFFSET CENTERLINE FORCE CALIPER

MICROTECH 

- OFFSET CENTERLINE caliper for hole center distance measurements
- Double Force control module with 8N external and 4N internal FORCE (Patents US10429165, UA146381)
- **MICRON** IP67 SWISS electronics with PRESET function
- MODIFICATION with **WIRELESS** data transfer **3 MODES DATA TRANSFER**: WIRELESS to MDS app (Windows, Android, iOS, MacOS); WIRELESS HID, WIRELESS HID+MAC
- Calibration certificate included (ISO17025 (Ilac MRA))



IP67  SWISS ELECTRONICS

Item No	Range		Reso- lution	Accu- racy	Anvil D		Force	Protection	Preset	WIRELESS
	mm	inch			standard	option				
<b>OFFSET CENTERLINE MICRON FORCE DIGITAL CALIPER IP67</b>										
141730156	10-160	0.4-6.4"	0,001	±20	10	20, 35	EXT 8 INT 4	IP67	•	•
141730206	10-210	0.4-8.4"								
141730306	10-310	0.4-12.4"		±30	20	35, 50	EXT 12			
141730516	20-520	0.8-20.4"								
141731016	20-1020	0.8-40.4"								
<b>OFFSET CENTERLINE WIRELESS MICRON FORCE CALIPER IP67</b>										
141730155	10-160	0.4-6.4"	0,001	±20	10	20, 35	EXT 8 INT 4	IP67	•	•
141730205	10-210	0.4-8.4"								
141730305	10-310	0.4-12.4"		±30	20	35, 50	EXT 12			
141730515	20-520	0.8-20.4"								
141731015	20-1020	0.8-40.4"								



ANVIL D=35MM  
**CUSTOM RANGE AND ANVILS FOR REQUEST**

## OPTIONAL ACCESSORIES

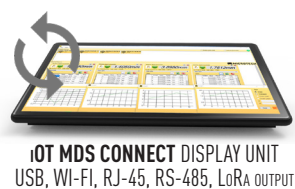

## DOWNLOAD APP



MADE IN UKRAINE

- OFFSET CENTERLINE caliper for hole center distance measurements
- Computerized **MICS** indication system Modification with Long range Wireless, Wireless HID or USB HID data transfer to Windows, Android, iOS, macOS, Linux systems direct to any app.
- Calibration certificate included (ISO17025 (Iac MRA))

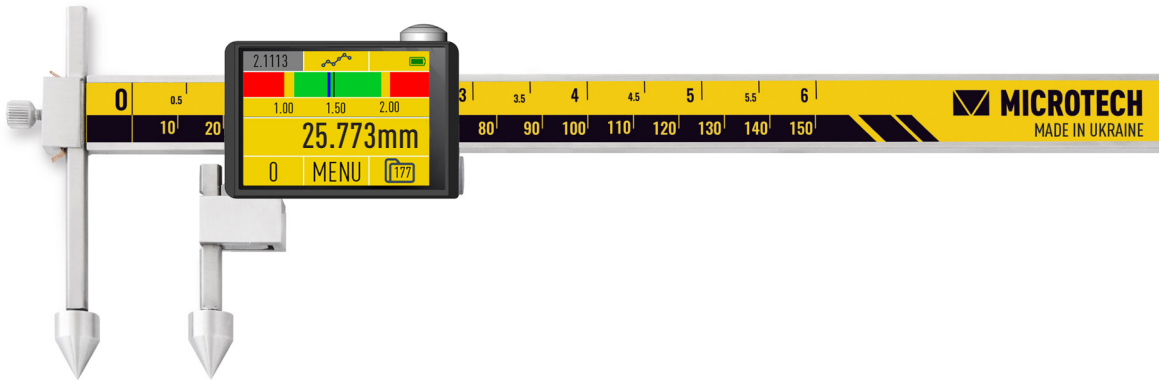
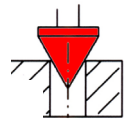
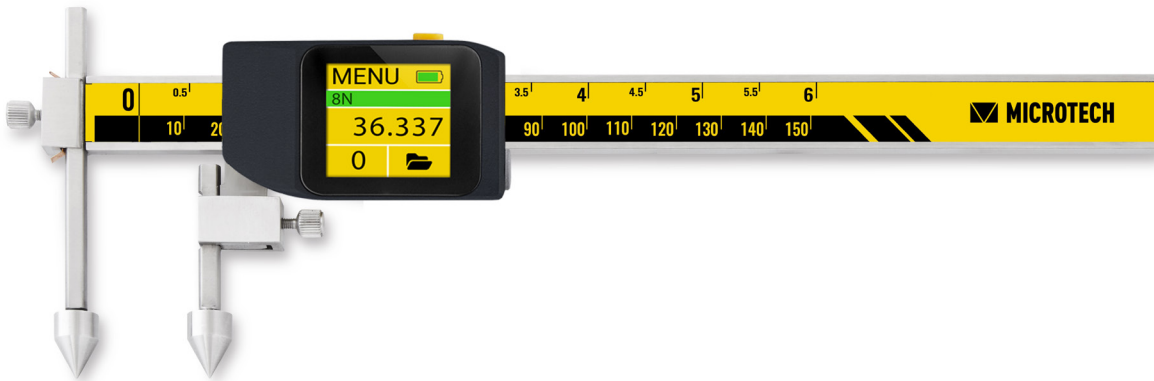

Item No	Range		Reso- lution	Accu- racy	Anvil D		Force	Protection	Preset	Go/NoGo	Max/Min	Formula	Timer	Temp comp	Linear corr	Calibr date	FW update	Recharge	Memory	WIRELESS	USB					
	mm	inch			mm	mm																mm				
141730157	10-160	0.4-6.4"	0,005	±20	10	20, 35	1-20	IP54	•	•	•	•	•	•	•	•	•	•	•	•	•	•				
141730207	10-210	0.4-8.4"		±25	20	35, 50			•	•	•	•	•	•	•	•	•	•	•	•	•	•	•	•		
141270307	10-310	0.4-12.4"		±30					•	•	•	•	•	•	•	•	•	•	•	•	•	•	•	•	•	•
141730517	20-520	0.8-20.4"	0,01	±40	20	35, 50	1-20	IP54	•	•	•	•	•	•	•	•	•	•	•	•	•	•				
141731017	20-1020	0.8-40.4"		±50					•	•	•	•	•	•	•	•	•	•	•	•	•	•	•	•	•	•
141731517	20-1520	0.8-40.4"		±60					•	•	•	•	•	•	•	•	•	•	•	•	•	•	•	•	•	•
141732017	20-2020	0.8-60.4"	0,001	±70	20	35, 50	1-20	IP54	•	•	•	•	•	•	•	•	•	•	•	•	•	•				
141733017	20-3020	0.8-80.4"		±15					•	•	•	•	•	•	•	•	•	•	•	•	•	•	•	•	•	•
<b>MICRON OFFSET CENTERLINE CALIPER</b>																										
141730158	10-160	0.4-6.4"	0,001	±20	10	20, 35	1-20	IP54	•	•	•	•	•	•	•	•	•	•	•	•	•	•				
141730208	10-210	0.4-8.4"		±20	20	35, 50			•	•	•	•	•	•	•	•	•	•	•	•	•	•	•	•		
141270308	10-310	0.4-12.4"		±20					•	•	•	•	•	•	•	•	•	•	•	•	•	•	•	•	•	•
141730518	20-520	0.8-20.4"	0,001	±30	20	35, 50	1-20	IP54	•	•	•	•	•	•	•	•	•	•	•	•	•	•				
141731018	20-1020	0.8-40.4"		±30					•	•	•	•	•	•	•	•	•	•	•	•	•	•	•	•	•	•



**OPTIONAL ACCESSORIES**

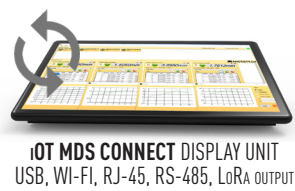
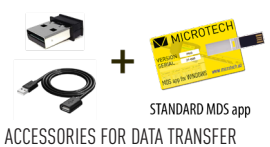

DOWNLOAD APP



- OFFSET corner caliper
- IP67 SWISS electronics with PRESET function
- MODIFICATION with **WIRELESS** data transfer **3 MODES DATA TRANSFER**: WIRELESS to MDS app (Windows, Android, iOS, MacOS); WIRELESS HID, WIRELESS HID+MAC
- Calibration certificate included (ISO17025 (Ilac MRA))



**IP67** **SWISS ELECTRONICS**

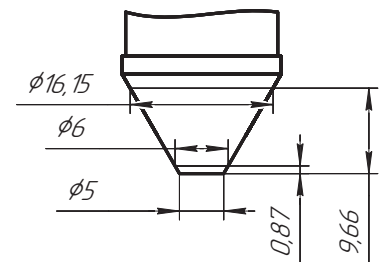
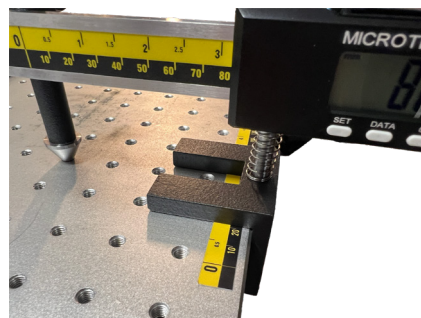
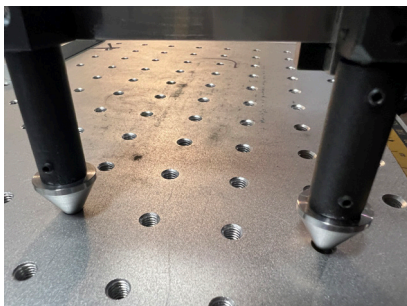

Item No	Range	Jaws		Resolution	Accuracy	Protection	Preset	WIRELESS
		slide	fix					
	mm	mm	mm	mm	$\mu$ m			
<b>OFFSET DIGITAL CALIPER IP67</b>								
141743553	0-500	110	40	0,01	$\pm 30$	IP67	•	
141743953	0-1000				$\pm 40$		•	
<b>OFFSET WIRELESS CALIPER IP67</b>								
141743554	0-500	110	40	0,01	$\pm 30$	IP67	•	•
141743954	0-1000				$\pm 40$		•	•

## OPTIONAL ACCESSORIES

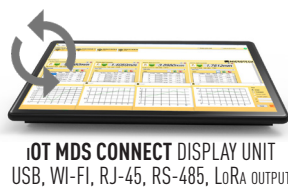

DOWNLOAD APP



- TUBE caliper for wall depth measurements
- Digital IP54 / IP67 or Computerized MICS indication system Modification with Long range Wireless, Wireless HID or USB HID data transfer to Windows, Android, iOS, macOS, Linux systems direct to any app.
- Calibration certificate included (ISO17025 (Ilac MRA))



Item No	Range		Reso- lution	Accu- racy	Anvil D	Force	Protection	Preset	Go/NoGo	Max/Min	Formula	Timer	Temp comp	Linear corr	Calibr date	Recharge	Memory	WIRELESS	USB
	mm	inch	mm	µm	mm	N													
<b>TUBE DIGITAL CALIPER IP54</b>																			
141230150	0-150	0-6"		±30															
141230200	0-200	0-8"	0,01	±30	4	-	IP54												
141230300	0-300	0-12"		±30															
<b>TUBE DIGITAL CALIPER IP67</b>																			
141230156	0-150	0-6"	0,001	±15		8/4		•											
141230153				±30	4			•											
141230203	0-200	0-8"	0,01	±30		-	IP67												
141230303	0-300	0-12"		±30				•											
<b>TUBE WIRELESS CALIPER IP67</b>																			
141230154	0-150	0-6"		±30				•											•
141230204	0-200	0-8"	0,01	±30	4	-	IP67												•
141230304	0-300	0-12"		±30				•											•
<b>TUBE COMPUTERIZED CALIPER IP54</b>																			
141230157	0-150	0-6"		±20				•	•	•	•	•	•	•	•	•	•	•	•
141230207	0-200	0-8"	0,005	±25	4	1-20	IP54	•	•	•	•	•	•	•	•	•	•	•	•
141230307	0-300	0-12"		±25				•	•	•	•	•	•	•	•	•	•	•	•
<b>MICRON TUBE COMPUTERIZED CALIPER IP54</b>																			
141230158	0-150	0-6"		±20				•	•	•	•	•	•	•	•	•	•	•	•
141230208	0-200	0-8"	0,001	±25	4	1-20	IP54	•	•	•	•	•	•	•	•	•	•	•	•
141230308	0-300	0-12"		±25				•	•	•	•	•	•	•	•	•	•	•	•

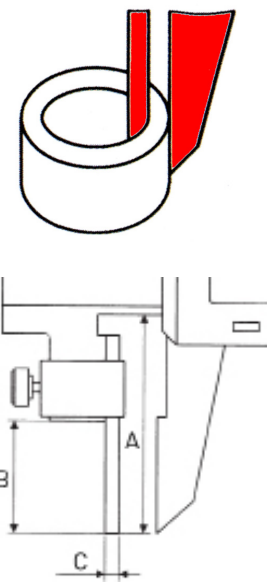

Range	A	B	C
mm	mm	mm	mm
0-150	46	30	4
0-200	50	40	4
0-300	50	40	4

- Metric and BSW, BSF, Tr **THREAD** measurements (internal & external)
- Interchangeable anvils pairs or anvils set
- **Double Force** control module with 8N external and 4N internal FORCE
- Patents US10429165, UA146381, UA202300560
- Waterproof **IP67** Swiss electronics with **PRESET** function
- **MODES DATA TRANSFER: WIRELESS** to MDS app (Windows, Android, iOS, MacOS); **WIRELESS HID, WIRELESS HID+MAC**
- Calibration certificate included (ISO17025 (Ilac MRA))

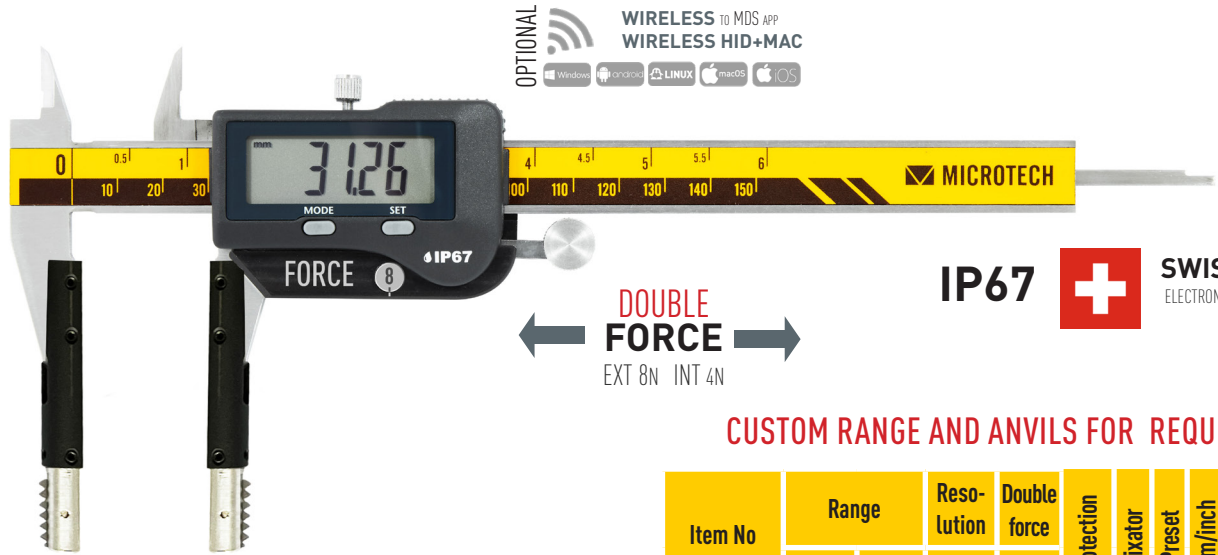

INTERNAL & EXTERNAL ANVILS ARE OPTIONAL

### CUSTOM RANGE AND ANVILS FOR REQUEST

Item No	Range		Reso- lution mm	Double force N	Protection	Fixator	Preset mm/inch	Auto on/off	WIRELESS
	mm	inch							
141076122T			0,001						
141078122T	0-150	0-6"	0,01	8 ext	IP-67				
141078192T			0,001	4 int					
141076322T			0,001						
141078322T	0-300	0-12"	0,01						
141078392T			0,01						

## THREAD ANVILS (PAIR)

Item No	Pitch	Angle	
	mm	grad	
141377110T	1,0	60°	
141377112T	1,25		
141377115T	1,5		
141377120T	2,0		
141377125T	2,5		
141377130T	3,0		
141377135T	3,5		
141377140T	4,0		
141377145T	4,5		
141377150T	5,0		
141377155T	5,5		
141377160T	6,0		
141377165T	6,5		
141377170T	7,0		
141377106T	SET Metric 60° 1,5-6mm (10pcs)		
141377107T	SET Metric 60° 1,5-7mm (12pcs)		

Item No	Pitch	Angle
	mm	grad
141377302T	2	Tr 30°
141377303T	3	
141377304T	4	
141377305T	5	
141377306T	6	
141377307T	7	
141377308T	8	
141377309T	9	
141377310T	10	
141377312T	12	
141377316T	16	
141377320T	20	
141377300T	SET Thread 30° 2-20mm (12pcs)	



Item No	Type	TPI	
141377211T	BSF 55°	11	
141377212T		10	
141377213T		9	
141377214T		8	
141377215T		7	
141377216T		6	
141377217T		5	
141377218T		4 1/2	
141377219T		4	
141377291T		SET BSF 55° 4-11 TPI (9pcs)	

Item No	Type	TPI
141377201T	BSW 55°	9
141377202T		8
141377203T		7
141377204T		6
141377205T		5
141377206T		4 1/2
141377207T		4
141377200T	SET BSW 55° 4-9 TPI (7pcs)	

- Waterproof **IP67** Swiss electronics with PRESET function
- High accuracy up to  $\pm 20\mu\text{m}$  on external jaws
- Calibration certificate included (ISO17025 (Ilac MRA))



**IP67**  **SWISS**  
ELECTRONICS

Item No	Range		Reso- lution	Accu- racy	Base	Protection	Preset
	mm	inch					
1432010153	0-150	0-6"	0,01	$\pm 20$	102	<b>IP67</b>	•
1432010203	0-200	0-8"		$\pm 30$			•
1432010303	0-300	0-12"		$\pm 40$			•
1432010503	0-500	0-20"		$\pm 50$	150		•
1432011003	0-1000	0-40"		$\pm 80$			•
1432012003	0-2000	0-80"		$\pm 100$			•
1432013003	0-3000	0-120"		$\pm 100$			•

**MICRON DEPTH** DIGITAL CALIPER IP67

- **MICRON** Waterproof **IP67** Swiss **MICRON** electronics with PRESET function
- High accuracy up to  $\pm 15\mu\text{m}$  on external jaws
- Calibration certificate included (ISO17025 (Ilac MRA))



**IP67**  **SWISS**  
ELECTRONICS

Item No	Range		Reso- lution	Accu- racy	Base	Protection	Preset
	mm	inch					
1432010156	0-150	0-6"	0,001	$\pm 15$	102	<b>IP67</b>	•
1432010206	0-200	0-8"		$\pm 20$			•
1432010306	0-300	0-12"		$\pm 30$			•
1432010506	0-500	0-20"		$\pm 30$			•



# WIRELESS DEPTH DIGITAL CALIPER IP67

- Waterproof IP67 Swiss electronics with PRESET function
- High accuracy up to  $\pm 20\mu\text{m}$  on external jaws
- **3 MODES DATA TRANSFER:** WIRELESS to MDS app (Windows, Android, iOS, MacOS); WIRELESS HID, WIRELESS HID+MAC
- Calibration certificate included (ISO17025 (Ilac MRA))



IP67 SWISS ELECTRONICS

Item No	Range		Reso- lution	Accu- racy	Base	Protection	Preset	WIRELESS
	mm	inch	mm	$\mu\text{m}$	mm			
1432010154	0-150	0-6"	0,01	$\pm 20$	102	IP67	•	•
1432010204	0-200	0-8"		$\pm 30$			•	•
1432010304	0-300	0-12"		$\pm 40$			•	•
1432010504	0-500	0-20"		$\pm 50$			•	•
1432011004	0-1000	0-40"	150	$\pm 80$	150	IP67	•	•
1432012004	0-2000	0-80"		$\pm 100$			•	•
1432013004	0-3000	0-120"		•			•	

# MICRON WIRELESS DEPTH DIGITAL CALIPER IP67

- MICRON Waterproof IP67 Swiss electronics with PRESET function
- High accuracy up to  $\pm 15\mu\text{m}$  on external jaws
- **3 MODES DATA TRANSFER:** WIRELESS to MDS app (Windows, Android, iOS, MacOS); WIRELESS HID, WIRELESS HID+MAC
- Calibration certificate included (ISO17025 (Ilac MRA))



IP67 SWISS ELECTRONICS

Item No	Range		Reso- lution	Accu- racy	Base	Protection	Preset	WIRELESS
	mm	inch	mm	$\mu\text{m}$	mm			
1432010155	0-150	0-6"	0,001	$\pm 15$	102	IP67	•	•
1432010205	0-200	0-8"		$\pm 20$			•	•
1432010305	0-300	0-12"		$\pm 30$			•	•
1432010505	0-500	0-20"		•			•	

DOWNLOAD APP



## OPTIONAL ACCESSORIES

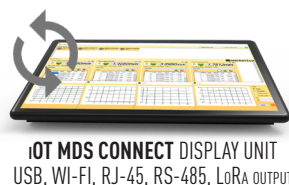

MADE IN UKRAINE

- High quality digital depth caliper **IP54** waterproof with optimal price level
- Micro USB data output (optional USB HID cable **29900830**)
- **Calibration** certificate included (ISO17025 (Ilac MRA))



Item No	Range		Reso- lution	Accu- racy	Base	Protection	USB
	mm	inch					
1432010152	0-150	0-6"	0,01	±20	102	IP54	•
1432010202	0-200	0-8"		±30			•
1432010302	0-300	0-12"		±30			•
1432010502	0-500	0-20"		±50			•

**OPTIONAL ACCESSORIES**



**141083000** USB HID DATA TRANSFER CABLE 2.5M  
DIRECT DATA TRANSFER, LIKE A KEYBOARD

**E-INK DEPTH** CALIPER

- **Industry 4.0** adopted Intelligent depth caliper with computerized MICS system (Patents US10184772, UA174949, UA126928)
- **ENERGY ECONOMY** 2.13" E-ink display (200+ working hours / 1 charging)
- **Functions:** Go/NoGo, Max/Min, Formula, Timer, Linear correction, Resolution selecting, Connection indication
- **Memory manager:** 1000 values, Statistics mode, Memory data transfer
- **4 MODES DATA TRANSFER:** WIRELESS to MDS app (Windows, Android, iOS, MacOS); WIRELESS HID, WIRELESS HID+MAC, USB HID
- **Calibration** certificate included (ISO17025 (Ilac MRA))

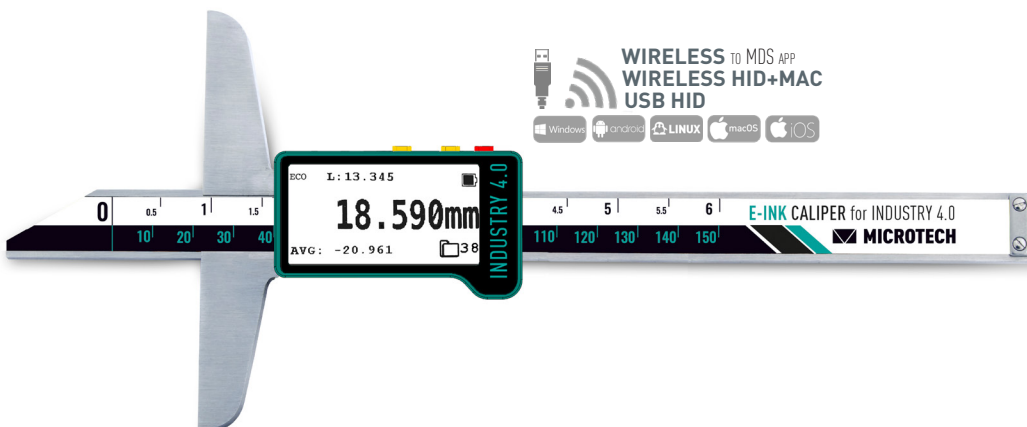

**DOWNLOAD APP**



Item No	Range		Reso- lution	Accu- racy	Base	Preset	Go/NoGo	Max/Min	Formula	Timer	Temp comp	Linear corr	Calibr date	Recharge	Memory	WIRELESS	USB	
	mm	inch																
1432010158	0-150	0-6"	0,005	±15	102	•	•	•	•	•	•	•	•	•	1000 val	•	•	
1432010208	0-200	0-8"		±20		•	•	•	•	•	•	•	•	•		•	•	•
1432010308	0-300	0-12"		±25		•	•	•	•	•	•	•	•	•		•	•	•

# COMPUTERIZED DEPTH CALIPER

- Industry 4.0 adopted depth caliper with computerized MICS system (Patents US10184772, UA174949, UA126928)
- Functions: Go/NoGo, Max/Min, Formula, Timer, Linear correction, Temperature correction, Resolution select, Connection indication
- Memory manager: 2000 values, Folders system, Statistics mode, Memory data transfer
- E-Force control module with Force selection 1-20N, color indication, AUTO-Force mode, Force indication
- **4 MODES DATA TRANSFER:** WIRELESS to MDS app (Windows, Android, iOS, MacOS); WIRELESS HID, WIRELESS HID+MAC, USB HID
- Calibration certificate included (ISO17025 (Ilac MRA))

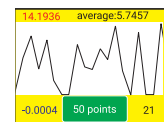

ON-LINE GRAPHIC MODE

Item No	Range		Resolution	Accuracy	Base	Preset	Go/NoGo	Max/Min	Formula	Timer	Temp comp	Linear corr	Calibr date	Recharge	Memory	WIRELESS	USB
	mm	inch															
1432010157	0-150	0-6"	0,005	±15	102	•	•	•	•	•	•	•	•	•	Folders / 2000 val	Long range / HID	Update
1432010207	0-200	0-8"		±20		•	•	•	•	•	•	•	•	•			
1432010307	0-300	0-12"		±25		•	•	•	•	•	•	•	•	•			
1432010507	0-500	0-20"	0,01	±40	150	•	•	•	•	•	•	•	•	•	Folders / 2000 val	Long range / HID	Update
1432011007	0-1000	0-40"		±50		•	•	•	•	•	•	•	•	•			
1432012007	0-2000	0-80"		±70		•	•	•	•	•	•	•	•	•			
1432013007	0-3000	0-1200"		±90		•	•	•	•	•	•	•	•				
MICRON COMPUTERIZED DEPTH CALIPER																	
1432010158	0-150	0-6"	0,001	±12	102	•	•	•	•	•	•	•	•	•	Folders / 2000 val	Long range / HID	Update
1432010208	0-200	0-8"		±15		•	•	•	•	•	•	•	•	•			
1432010308	0-300	0-12"		±15		•	•	•	•	•	•	•	•	•			
1432010508	0-500	0-20"		±25		•	•	•	•	•	•	•	•	•			
1432011008	0-1000	0-40"		±30		•	•	•	•	•	•	•	•	•			

DOWNLOAD APP



- Double hook depth calipers
- Digital IP54 / IP67 or Computerized MICS indication system Modification with Long range Wireless, Wireless HID or USB HID data transfer to Windows, Android, iOS, macOS, Linux systems direct to any app.
- Calibration certificate included (ISO17025 (Ilac MRA))



IP67  SWISS ELECTRONICS

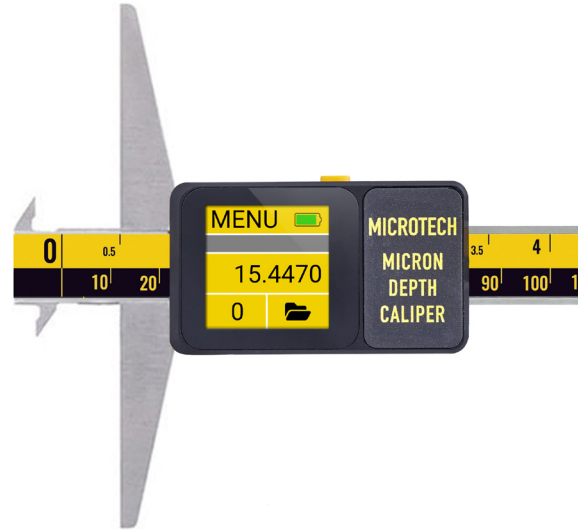
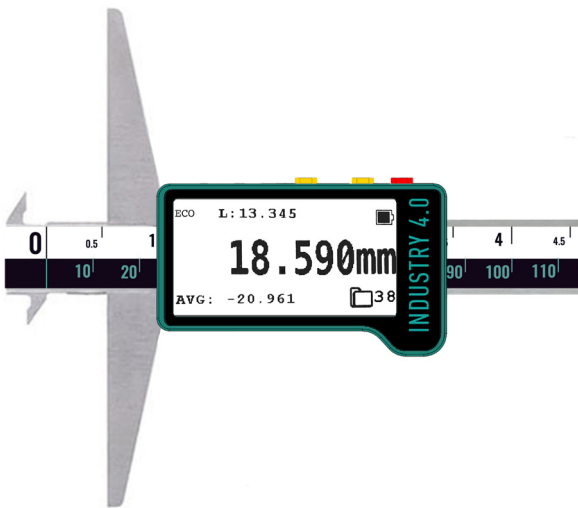

Item No	Range		Resolution	Accuracy	Base	Protection	Preset	Go/NoGo	Max/Min	Formula	Timer	Temp comp	Linear corr	Calibr date	Recharge	Memory	WIRELESS	USB	
	mm	inch																	mm
DIGITAL DEPTH CALIPER IP54 DOUBLE HOOK																			
1432020152	0-150	0-6"	0,01	±20	102	IP54													
1432020302	0-300	0-12"		±30															
DIGITAL DEPTH CALIPER IP67 DOUBLE HOOK																			
1432020153	0-150	0-6"	0,01	±20	102	IP67	•												
1432020303	0-300	0-12"					•												
WIRELESS DEPTH CALIPER IP67 DOUBLE HOOK																			
1432020154	0-150	0-6"	0,01	±20	102	IP67	•												
1432020304	0-300	0-12"					•												
E-INK DEPTH CALIPER IP54 DOUBLE HOOK																			
1432020158	0-150	0-6"	0,005	±15	102	IP54	•	•	•	•	•	•	•	•	•	•	•	•	•
1432020308	0-300	0-12"		±25			•	•	•	•	•	•	•	•	•	•	•	•	•
COMPUTERIZED DEPTH CALIPER IP54 DOUBLE HOOK																			
1432020157	0-150	0-6"	0,005	±15	102	IP54	•	•	•	•	•	•	•	•	•	•	•	•	•
1432020307	0-300	0-12"		±25			•	•	•	•	•	•	•	•	•	•	•	•	•

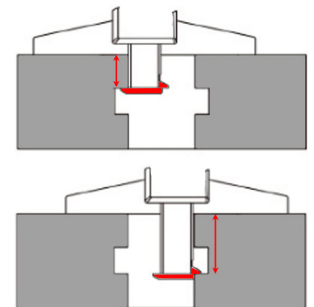

DOWNLOAD APP



- PIN tip depth calipers
- Digital IP67 or Computerized MICS indication system Modification with Long range Wireless, Wireless HID or USB HID data transfer to Windows, Android, iOS, macOS, Linux systems direct to any app.
- Calibration certificate included (ISO17025 (Ilac MRA))

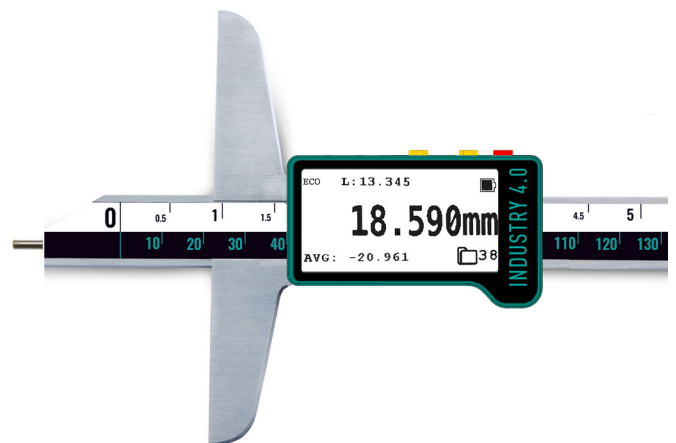

Item No	Range		Reso- lution	Accu- racy	Base	Pin	Protection	Preset	Go/NoGo	Max/Min	Formula	Timer	Temp comp	Linear corr	Calibr date	Recharge	Memory	WIRELESS	USB			
	mm	inch																				
<b>DIGITAL DEPTH CALIPER IP67 PIN TIP</b>																						
1432030153	0-150	0-6"	0,01	±20	102	D 1,5	IP67	•														
1432030303	0-300	0-12"		±30				•														
1432030503	0-500	0-20"		±40				•														
<b>WIRELESS DEPTH CALIPER IP67 PIN TIP</b>																						
1432030154	0-150	0-6"	0,01	±20	102	D 1,5	IP67	•											•			
1432030304	0-300	0-12"		±30				•														•
1432030504	0-500	0-20"		±40				•														•
<b>E-INK DEPTH CALIPER IP54 PIN TIP</b>																						
1432030158	0-150	0-6"	0,005	±15	102	D 1,5	IP54	•	•	•	•	•	•	•	•	•	•	•	•			
1432030308	0-300	0-12"		±25				•	•	•	•	•	•	•	•	•	•	•	•	•	•	•
<b>COMPUTERIZED DEPTH CALIPER IP54 PIN TIP</b>																						
1432030157	0-150	0-6"	0,005	±15	102	D 1,5	IP54	•	•	•	•	•	•	•	•	•	•	•	•			
1432030307	0-300	0-12"		±25				•	•	•	•	•	•	•	•	•	•	•	•	•	•	•
1432030507	0-500	0-20"		±30				•	•	•	•	•	•	•	•	•	•	•	•	•	•	•

DOWNLOAD APP



- MICRON Waterproof IP67 Swiss MICRON electronics with PRESET function
- High accuracy up to  $\pm 10\mu\text{m}$  on external jaws
- Calibration certificate included (ISO17025 (Ilac MRA))

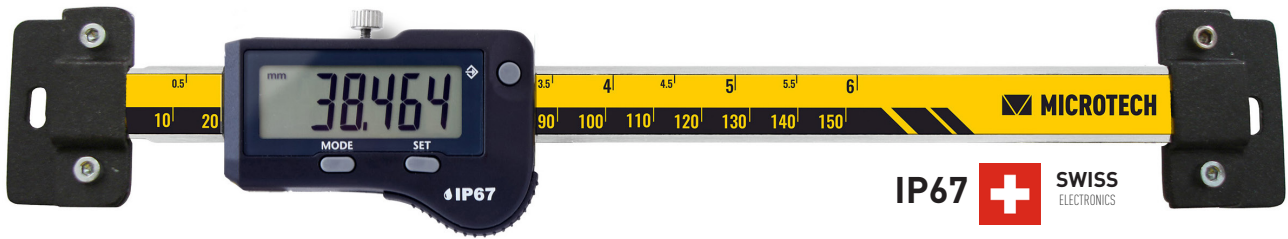

1  $\mu\text{m}$

Item No	Range		Reso- lution	Accu- racy	Protection	Preset
	mm	inch	mm	$\mu\text{m}$		
142501146	0-150	0-6"		$\pm 10$		•
142502146	0-200	0-8"	0,001	$\pm 12$	IP67	•
142503146	0-300	0-12"		$\pm 15$		•

MICRON WIRELESS READOUT LINEAR SCALE DIGITAL IP67

- MICRON Waterproof IP67 Swiss electronics with PRESET function
- High accuracy up to  $\pm 10\mu\text{m}$  on external jaws
- 3 MODES DATA TRANSFER: WIRELESS to MDS app (Windows, Android, iOS, MacOS); WIRELESS HID, WIRELESS HID+MAC
- Calibration certificate included (ISO17025 (Ilac MRA))



1  $\mu\text{m}$

IP67 SWISS ELECTRONICS

DOWNLOAD APP



OPTIONAL ACCESSORIES

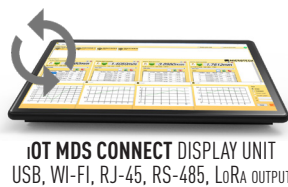
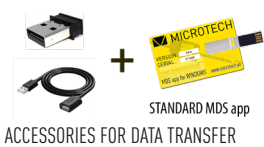

Item No	Range		Reso- lution	Accu- racy	Protection	Preset	WIRELESS
	mm	inch	mm	$\mu\text{m}$			
142501148	0-150	0-6"		$\pm 10$		•	•
142502148	0-200	0-8"	0,001	$\pm 12$	IP67	•	•
142503148	0-300	0-12"		$\pm 15$		•	•

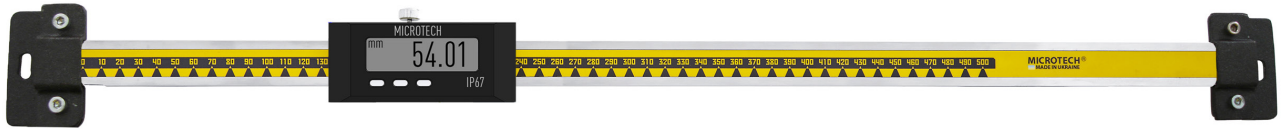

Item No	Range		Reso- lution	Accu- racy	Protection	Preset
	mm	inch				
142505147	0-500	0-20"	0,01	±40	IP67	•
142506147	0-600	0-24"		±50		•
142510147	0-1000	0-40"		±70		•
142515147	0-1500	0-60"		±80		•
142520147	0-2000	0-80"		±90		•
142525147	0-2500	0-100"		±100		•
142530147	0-3000	0-120"		±110		•
142540147	0-4000	0-160"		±120		•
142550147	0-5000	0-200"				•

**IP67** **SWISS ELECTRONICS**

## MICRON READOUT LINEAR SCALE DIGITAL IP67

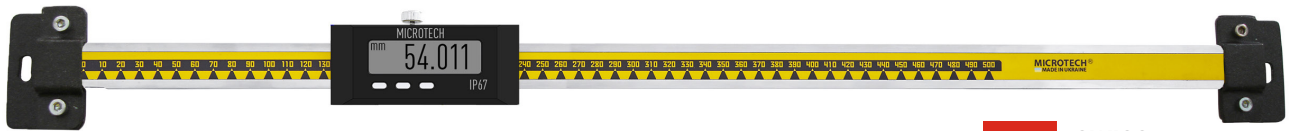

Item No	Range		Reso- lution	Accu- racy	Protection	Preset
	mm	inch				
142505146	0-500	0-20"	0,001	±20	IP67	•
142510146	0-1000	0-40"		±30		•
142515146	0-1500	0-60"		±40		•
142520146	0-2000	0-80"		±50		•



**IP67** **SWISS ELECTRONICS**

## MICRON WIRELESS READOUT LINEAR SCALE DIGITAL IP67

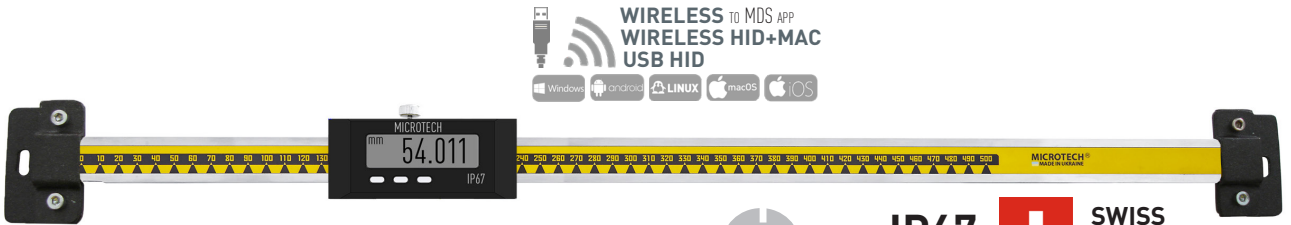

**IP67** **SWISS ELECTRONICS**

Item No	Range		Reso- lution	Accu- racy	Protection	Preset	WIRELESS
	mm	inch					
142505148	0-500	0-20"	0,001	±20	IP67	•	•
142510148	0-1000	0-40"		±30		•	•
142515148	0-1500	0-60"		±40		•	•
142520148	0-2000	0-80"		±50		•	•

### OPTIONAL ACCESSORIES



**IoT MDS CONNECT DISPLAY UNIT**  
USB, WI-FI, RJ-45, RS-485, LoRa OUTPUT

- Industry 4.0 adopted linear scale with computerized MICS system (Patents US10184772, UA174949, UA126928)
- Functions: Go/NoGo, Max/Min, Formula, Timer, Linear correction, Temperature correction, Resolution select, Connection indication
- Memory manager: 2000 values, Folders system, Statistics mode, Memory data transfer
- RANGE up to 5000 mm
- **4 MODES DATA TRANSFER:** WIRELESS to MDS app (Windows, Android, iOS, MacOS); WIRELESS HID, WIRELESS HID+MAC, USB HID
- Calibration certificate included (ISO17025 (Ilac MRA))

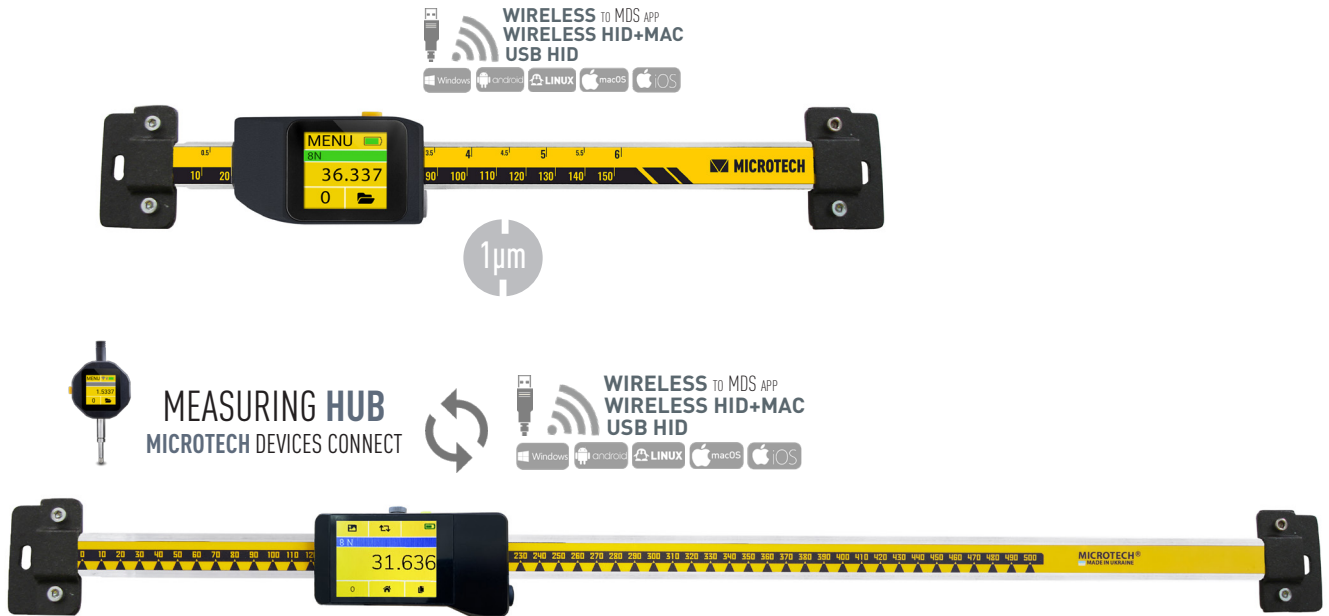

Item No	Range		Reso- lution	Accu- racy	Protection	Measuring HUB	Graphic	Analog scale	Preset	Go/NoGo	Max/Min	Formula	Timer	Temp comp	Linear corr	Calibr date	Recharge	Memory	WIRELESS	USB	
	mm	inch	mm	µm																	
142501140	0-150	0-6"	0,005	±10	IP54																
142502140	0-200	0-8"		±15																	
142503140	0-300	0-12"		±20																	
142505140	0-500	0-20"		±30																	
142510140	0-1000	0-40"		±40																	
142515140	0-1500	0-60"		±50																	
142520140	0-2000	0-80"		±60																	
142525140	0-2500	0-100"		±70																	
142530140	0-3000	0-120"		±80																	
142540140	0-4000	0-160"	±100																		
142550140	0-5000	0-200"	±110																		
<b>MICRON COMPUTERIZED READOUT LINEAR SCALE</b>																					
142501141	0-150	0-6"	0,001	±8	IP54																
142502141	0-200	0-8"		±12																	
142503141	0-300	0-12"		±15																	
142505141	0-500	0-20"		±20																	
142510141	0-1000	0-40"		±30																	
142515141	0-1500	0-60"		±35																	
142520141	0-2000	0-80"		±40																	

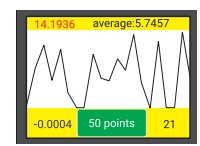

**ON-LINE GRAPHIC MODE**

**OPTIONAL ACCESSORIES**

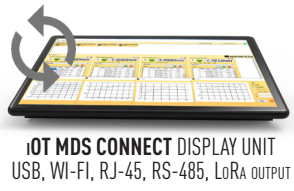
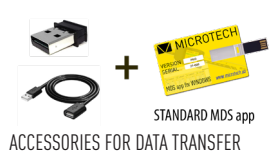

**DOWNLOAD APP**





# MICRON LINEAR SCALE WITH MAGNIFIER

- MICRON linear scale with IP67 Swiss electronics
- Magnifier 10x loupe with scale
- RANGE up to 3000 mm
- Calibration certificate included (ISO17025 (Ilac MRA))

IP67  SWISS ELECTRONICS

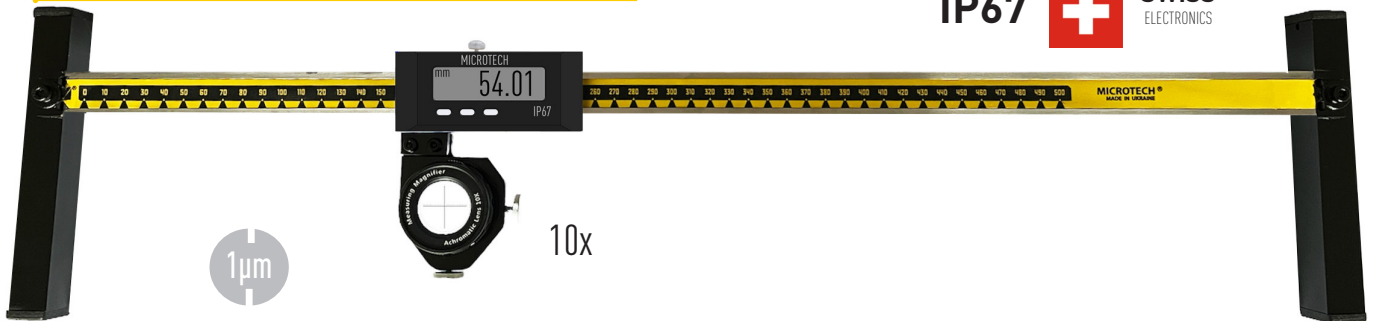

Item No	Range		Resolution	Accuracy	Vision	Protection	Preset	Max/Min
	mm	inch						
142505151	0-500	0-20"	0,001	±20	10x magnifier	IP67	•	•
142510151	0-1000	0-40"		±30			•	•
142515151	0-1500	0-60"		±40			•	•
142520151	0-2000	0-80"		±50			•	•
142530151	0-3000	0-120"		±70			•	•

## OPTIONAL ACCESSORIES



20x, 25x MAGNIFIER

# MICRON WIRELESS LINEAR SCALE WITH MAGNIFIER

- MICRON linear scale with IP67 Swiss electronics
- Magnifier 10x loupe with scale
- RANGE up to 3000 mm
- **3 MODES DATA TRANSFER:** WIRELESS to MDS app (Windows, Android, iOS, MacOS); WIRELESS HID, WIRELESS HID+MAC
- Calibration certificate included (ISO17025 (Ilac MRA))

IP67  SWISS ELECTRONICS

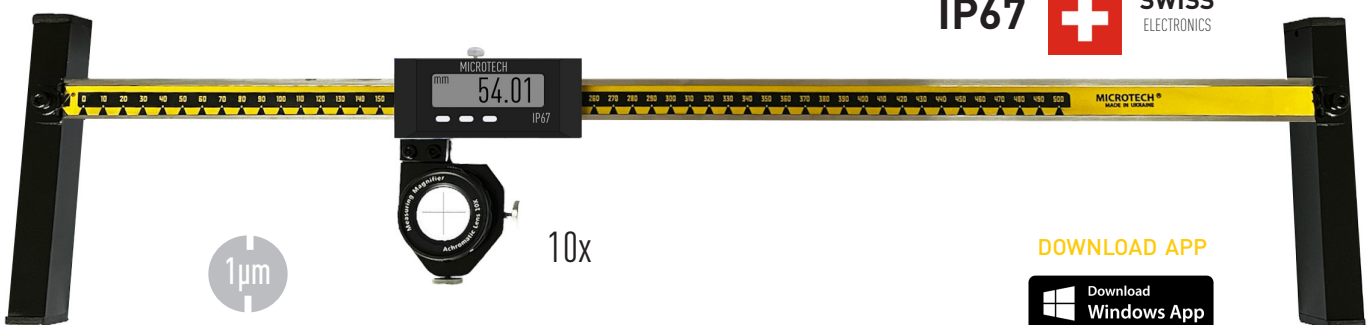

Item No	Range		Resolution	Accuracy	Vision	Protection	Preset	Max/Min	WIRELESS
	mm	inch							
142505152	0-500	0-20"	0,001	±20	10x magnifier	IP67	•	•	•
142510152	0-1000	0-40"		±30			•	•	
142515152	0-1500	0-60"		±40			•	•	
142520152	0-2000	0-80"		±50			•	•	
142530152	0-3000	0-120"		±70			•	•	

## DOWNLOAD APP



## OPTIONAL ACCESSORIES



IoT MDS CONNECT DISPLAY UNIT  
USB, WI-FI, RJ-45, RS-485, LoRa OUTPUT

- Industry 4.0 adopted linear scale with computerized MICS system (Patents US10184772, UA174949, UA126928)
- Magnifier 10x loupe with scale
- Functions: Go/NoGo, Max/Min, Formula, Timer, Linear correction, Temperature correction, Resolution select, Connection indication
- Memory manager: 2000 values, Folders system, Statistics mode, Memory data transfer
- RANGE up to 3000 mm
- **4 MODES DATA TRANSFER:** WIRELESS to MDS app (Windows, Android, iOS, MacOS); WIRELESS HID, WIRELESS HID+MAC, USB HID
- Calibration certificate included (ISO17025 (Iltac MRA))

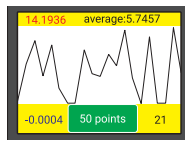
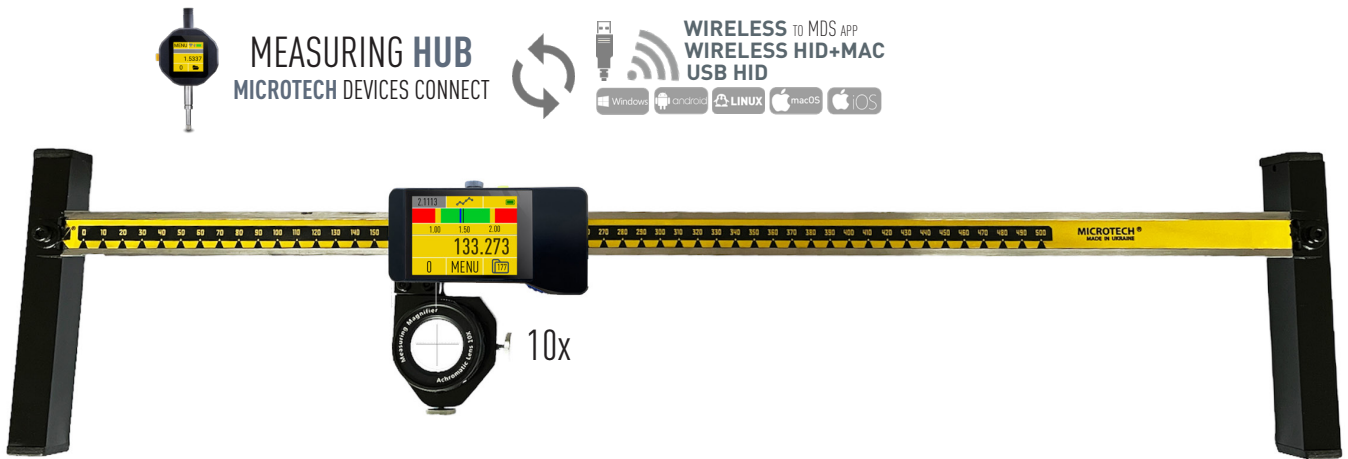

**ON-LINE GRAPHIC MODE**



**CUSTOM RANGE AND CONFIGURATION FOR REQUEST**

Item No	Range		Reso- lution mm	Accu- racy µm	Vision	Protection	2D connection	Graphic	Analog scale	Preset	Go/NoGo	Max/Min	Formula	Timer	Temp comp	Linear corr	Calibr date	Recharge	Memory	Folders	WIRELESS	USB HID					
	mm	inch																									
142505156	0-500	0-20"	0,01	±30	10x magnifier	IP54	•	•	•	•	•	•	•	•	•	•	•	•	2000 val	•	•	•					
142510156	0-1000	0-06"		±40			•	•	•	•	•	•	•	•	•	•	•	•		•	•	•	•	•			
142515156	0-1500	0-60"		±50			•	•	•	•	•	•	•	•	•	•	•	•		•	•	•	•	•	•		
142520156	0-2000	0-80"		±70			•	•	•	•	•	•	•	•	•	•	•	•		•	•	•	•	•	•	•	
142530156	0-3000	0-120"		±80			•	•	•	•	•	•	•	•	•	•	•	•		•	•	•	•	•	•	•	•
142505157	0-500	0-20"	0,001	±20	10x magnifier	IP54	•	•	•	•	•	•	•	•	•	•	•	•	2000 val	•	•	•					
142510157	0-1000	0-06"		±25			•	•	•	•	•	•	•	•	•	•	•	•		•	•	•	•	•	•	•	
142515157	0-1500	0-60"		±30			•	•	•	•	•	•	•	•	•	•	•	•		•	•	•	•	•	•	•	•
142520157	0-2000	0-80"		±40			•	•	•	•	•	•	•	•	•	•	•	•		•	•	•	•	•	•	•	•
142530157	0-3000	0-120"		±50			•	•	•	•	•	•	•	•	•	•	•	•		•	•	•	•	•	•	•	•

**OPTIONAL ACCESSORIES**

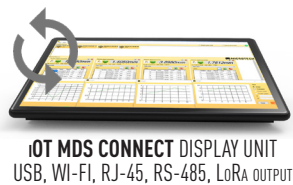

**DOWNLOAD APP**



- Industry 4.0 adopted linear scale with computerized MICS system (Patents US10184772, UA174949, UA126928)
- ROLL SLIDING SYSTEM
- MICROSCOPE with 7" display and 12Mp camera
- Functions: Go/NoGo, Max/Min, Formula, Timer, Linear correction, Temperature correction, Resolution select, Connection indication
- Memory manager: 2000 values, Folders system, Statistics mode, Memory data transfer
- RANGE up to 3500 mmm
- **4 MODES DATA TRANSFER:** WIRELESS to MDS app (Windows, Android, iOS, MacOS); WIRELESS HID, WIRELESS HID+MAC, USB HID
- Calibration certificate included (ISO17025 (Ilac MRA))

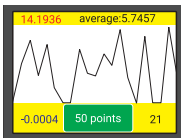

**ON-LINE GRAPHIC MODE**

WIRELESS TO MDS APP  
WIRELESS HID+MAC  
USB HID



**ROLL SLIDING SYSTEM**  
- Light aluminium base  
- 2x steel roll for easy sliding



**CUSTOM RANGE AND CONFIGURATION FOR REQUEST**

Item No	Range		Reso- lution	Accu- racy	Vision	Roll system	Fine adjust	Measuring HUB	Graphic	Analog scale	Preset	Go/NoGo	Max/Min	Formula	Timer	Temp comp	Linear corr	Calibr date	Recharge	Memory	Folders	WIRELESS	USB HID	
	mm	inch																						mm
142505158	0-550	0-22"	0,001	±20	Digital 7"LED 12Mp	•	•	•	•	•	•	•	•	•	•	•	•	•	•	2000 val	•	•	•	
142510158	0-1150	0-46"		±30		•	•	•	•	•	•	•	•	•	•	•	•	•	•		•	•	•	•
142515158	0-1500	0-60"		±40		•	•	•	•	•	•	•	•	•	•	•	•	•	•		•	•	•	•
142520158	0-2000	0-80"		±50		•	•	•	•	•	•	•	•	•	•	•	•	•	•		•	•	•	•
142525158	0-2500	0-100"		±55		•	•	•	•	•	•	•	•	•	•	•	•	•	•		•	•	•	•
142530158	0-3000	0-120"		±60		•	•	•	•	•	•	•	•	•	•	•	•	•	•		•	•	•	•
142535158	0-3500	0-140"		±65		•	•	•	•	•	•	•	•	•	•	•	•	•	•		•	•	•	•

**OPTIONAL ACCESSORIES**

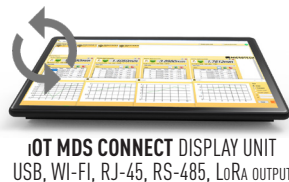

**DOWNLOAD APP**





- Bore calipers for bore reading without removing the bar
- **MICRON** Swiss Digital IP67 electronics with PRESET function.
- Calibration certificate included (ISO17025 (Ilac MRA))

Item No	Range				Reso- lution	Accu- racy	Jaws		Preset
	Internal		External				Down	Depth	
	mm	inch	mm	inch					
141851126	22-300	0.9-12"	0-300	0-6"		±40	40	50	•
141851156	24-500	1-20"	0-500	0-20"	0,001	±60	60	60	•
141851166	30-600	1.2-24"	0-600	0-24"		±90	90	100	•

BORE COMPUTERIZED CALIPER

- Bore calipers for bore reading without removing the bar
- Computerized **MICS** indication system Modification with Long range Wireless, Wireless HID or USB HID data transfer to Windows, Android, iOS, macOS, Linux systems direct to any app.
- Calibration certificate included (ISO17025 (Ilac MRA))



WIRELESS TO MDS APP  
WIRELESS HID+MAC  
USB HID

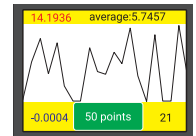

ON-LINE GRAPHIC MODE

Item No	Range				Reso- lution	Accu- racy	Jaws		Constant Force	Measuring HUB	Analog scale	Graphic	Preset	Go/NoGo	Max/Min	Formula	Timer	Temp comp	Linear corr	Calibr date	Recharge	Memory	WIRELESS	USB
	Internal		External				Down	Depth																
	mm	inch	mm	inch																				
141851127	22-300	0.9-12"	0-300	0-6"		±30	40	50	•	•	•	•	•	•	•	•	•	•	•	•	•	•	•	•
141851157	24-500	1-20"	0-500	0-20"	0,01	±40	60	60	•	•	•	•	•	•	•	•	•	•	•	•	•	•	•	•
141851167	30-600	1.2-24"	0-600	0-24"		±70	90	100	•	•	•	•	•	•	•	•	•	•	•	•	•	•	•	•
MICRON BORE COMPUTERIZED CALIPERS																								
141851128	22-300	0.9-12"	0-300	0-6"		±30	40	50	•	•	•	•	•	•	•	•	•	•	•	•	•	•	•	•
141851158	24-500	1-20"	0-500	0-20"	0,001	±40	60	60	•	•	•	•	•	•	•	•	•	•	•	•	•	•	•	•
141851168	30-600	1.2-24"	0-600	0-24"		±70	90	100	•	•	•	•	•	•	•	•	•	•	•	•	•	•	•	•

DOWNLOAD APP



# CONSTANT FORCE BORE CALIPER

- Bore calipers for bore reading without removing the bar
- CONSTANT Force module for high accuracy and repeatability
- Computerized **MICS** indication system Modification with **Long range** Wireless, Wireless HID or USB HID data transfer to Windows, Android, iOS, macOS, Linux systems direct to any app.
- Calibration certificate included (ISO17025 (Iac MRA))

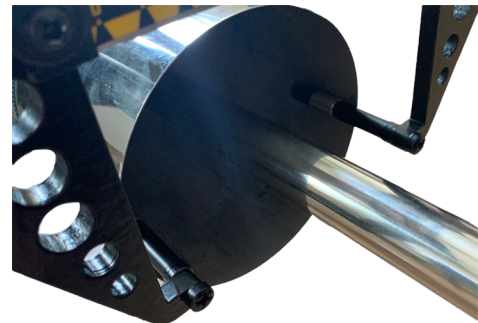
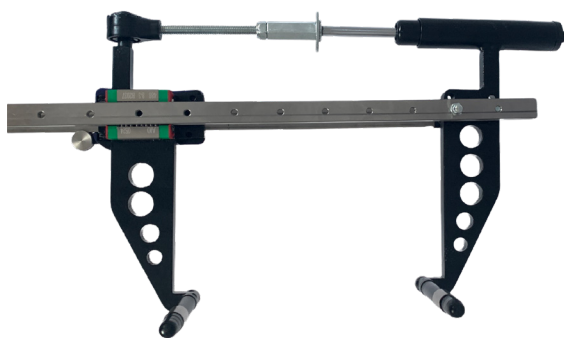
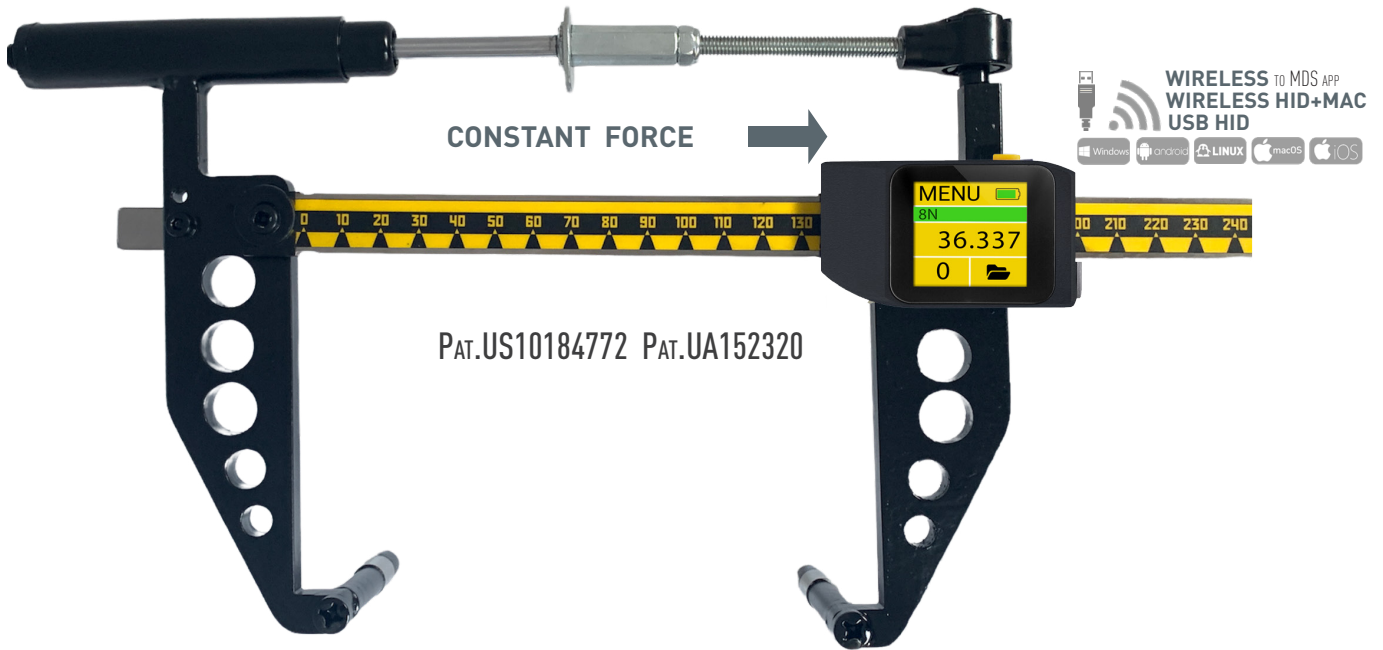

Item No	Range		Reso- lution	Accu- racy	Jaws			Max bore D	Roll system	Constant Force	Measuring HUB	Analog scale	Graphic	Preset	Go/NoGo	Max/Min	Formula	Timer	Temp comp	Linear corr	Calibr date	Recharge	Memory	WIRELESS	USB
	Internal				Down	Depth	Anvil D																		
	mm	inch																							
141851037	20-300	0.9-12"	0,01	±20	100	60	10	180	•	•	•	•	•	•	•	•	•	•	•	•	•	•	•	•	•
141851057	30-500	1-20"		±35	150	100	14	270	•	•	•	•	•	•	•	•	•	•	•	•	•	•	•	•	•
141851107	50-1000	2-40"		±40	150	100	14	270	•	•	•	•	•	•	•	•	•	•	•	•	•	•	•	•	•
141851157	1000-1500	40-60"		±45	200	150	18	370	•	•	•	•	•	•	•	•	•	•	•	•	•	•	•	•	•
141851207	1500-2000	60-80"		±55	250	150	18	460	•	•	•	•	•	•	•	•	•	•	•	•	•	•	•	•	•
141851257	2000-2500	80-100"		±60	300	200	26	550	•	•	•	•	•	•	•	•	•	•	•	•	•	•	•	•	•

## OPTIONAL ACCESSORIES

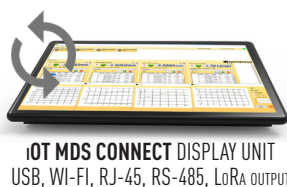

## DOWNLOAD APP



- Industry 4.0 adopted Tablet height gauge with computerized MICS system with 2.4" color Touchscreen
- Patents US10184772, UA144230, UA126928, UA99686, UA2022050400
- Functions: On-line Graphic, Analog scale, Go/NoGo, Max/Min, Formula, Timer, Linear correction, Temperature correction
- Measuring HUB: Wireless MICROTECH instrument connection, Synchronization, 2D mode, 2D Graph, Probe mode, Compensation
- Memory manager: 2000 values, Folders system, Statistics mode, Memory data transfer
- E-Force control module with Force selection 1-20N, color indication, AUTO-Force mode
- **4 MODES DATA TRANSFER:** WIRELESS to MDS app (Windows, Android, iOS, MacOS); WIRELESS HID, WIRELESS HID+MAC, USB HID
- Calibration certificate included (ISO17025 (Ilac MRA))



WIRELESS TO MDS APP  
WIRELESS HID+MAC  
USB HID

Windows Android LINUX macOS iOS

MEASURING HUB  
MICROTECH DEVICES CONNECT

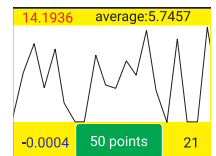

**ON-LINE GRAPHIC MODE**

Item No	Range		Resol.	Accur.	2D connect	Measuring HUB	Graphic	Analog scale	Preset	Go/NoGo	Max/Min	Formula	Timer	Temp comp	Linear corr	Calibr date	Recharge	Memory	WIRELESS	USB
	mm	inch																		
144303260	0-300	0-12"	0,001	±20	•	•	•	•	•	•	•	•	•	•	•	•	•	Folders / 2000 val	Long range / HID	USB HID / Update
144305260	0-500	0-20"		±30	•	•	•	•	•	•	•	•	•	•	•	•	•			
144310260	0-1000	0-40"		±50	•	•	•	•	•	•	•	•	•	•	•	•	•			
144315260	0-1500	0-60"	0,01	±60	•	•	•	•	•	•	•	•	•	•	•	•	•	Folders / 2000 val	Long range / HID	USB HID / Update
144320260	0-2000	0-80"		±80	•	•	•	•	•	•	•	•	•	•	•	•	•			

**OPTIONAL ACCESSORIES**

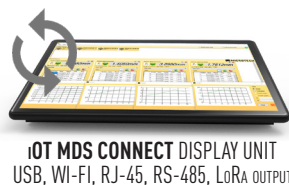

**DOWNLOAD APP**



- Industry 4.0 adopted Tablet Force height gauge with computerized MICS system with 2.4" color Touchscreen
- Patents US10184772, UA144230, UA126928, UA99686, UA2022050400
- Functions: On-line Graphic, Analog scale, Go/NoGo, Max/Min, Formula, Timer, Linear correction, Temperature correction
- Measuring HUB: Wireless MICROTECH instrument connection, Synchronization, 2D mode, 2D Graph, Probe mode, Compensation
- Memory manager: 2000 values, Folders system, Statistics mode, Memory data transfer
- E-Force control module with Force selection 1-20N, color indication, AUTO-Force mode
- **4 MODES DATA TRANSFER:** WIRELESS to MDS app (Windows, Android, iOS, MacOS); WIRELESS HID, WIRELESS HID+MAC, USB HID
- Calibration certificate included (ISO17025 (Ilac MRA))

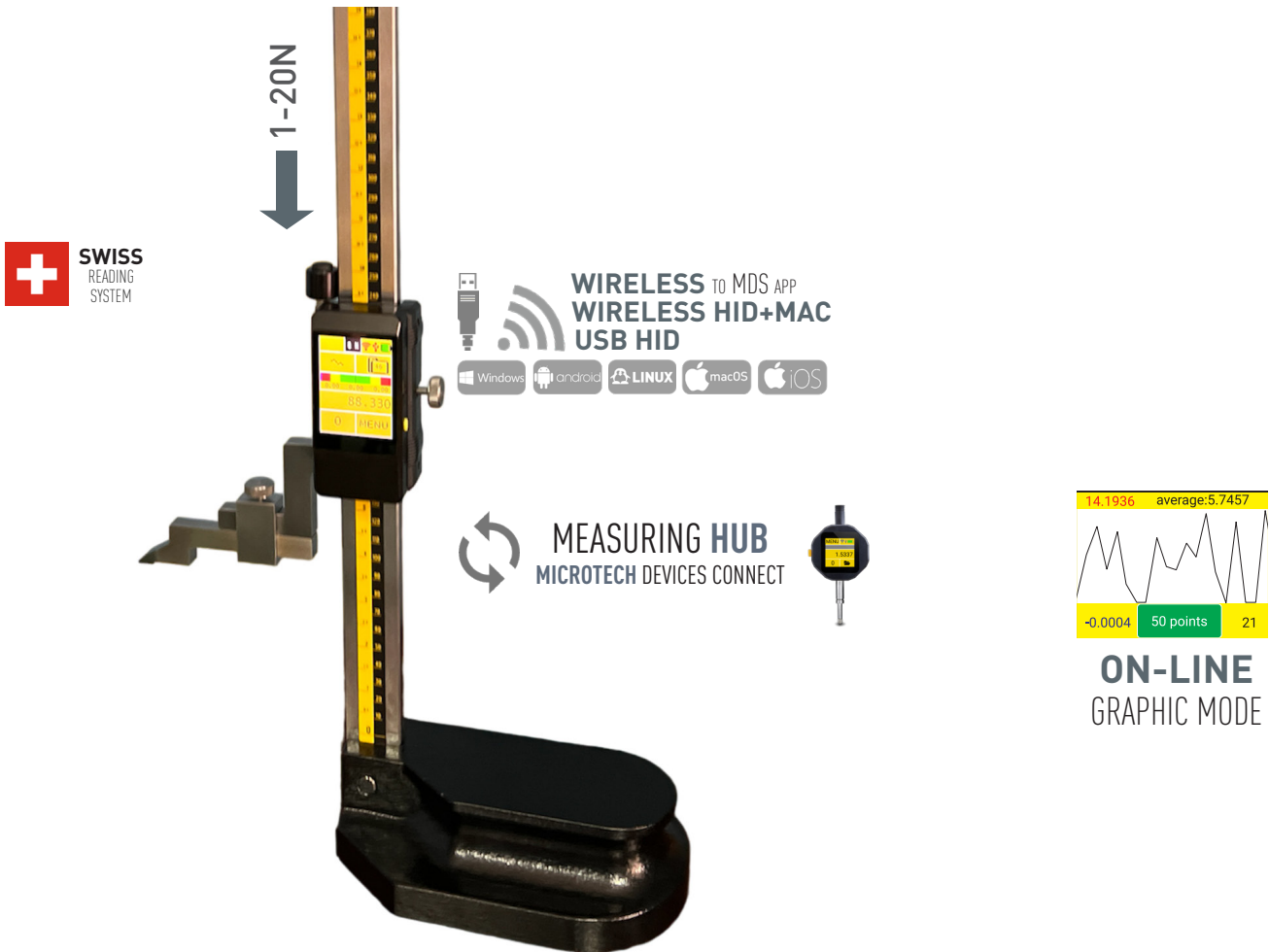

Item No	Range		Resol.	Accur.	eForce control	2D connect	Measuring HUB	Graphic	Analog scale	Preset	Go/NoGo	Max/Min	Formula	Timer	Temp comp	Linear corr	Calibr date	Recharge	Memory	WIRELESS	USB			
	mm	inch																				mm	µm	N
144303263	0-300	0-12"	0,001	±15	1-20N	•	•	•	•	•	•	•	•	•	•	•	•	•	•	•	•	•		
144305263	0-500	0-20"		±20		•	•	•	•	•	•	•	•	•	•	•	•	•	•	•	•	•	•	
144310263	0-1000	0-40"		±30		•	•	•	•	•	•	•	•	•	•	•	•	•	•	•	•	•	•	•
144315263	0-1500	0-60"		±45		•	•	•	•	•	•	•	•	•	•	•	•	•	•	•	•	•	•	•
144320263	0-2000	0-80"		±60		•	•	•	•	•	•	•	•	•	•	•	•	•	•	•	•	•	•	•

### OPTIONAL ACCESSORIES

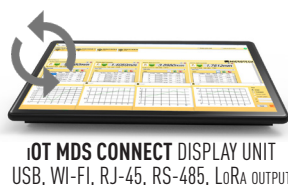

### DOWNLOAD APP



- Industry 4.0 adopted Tablet double column micron height gauge with computerized MICS system with 3.5" color Touchscreen
- Patents US10184772, UA144230, UA126928, UA2022050400
- Functions: On-line Graphic, Analog scale, Go/NoGo, Max/Min, Formula, Timer, Linear correction, Temperature correction
- Measuring HUB: Wireless MICROTECH instrument connection, Synchronization, 2D mode, 2D Graph, Probe mode, Compensation
- Memory manager: 2000 values, Folders system, Statistics mode, Memory data transfer
- **4 MODES DATA TRANSFER:** WIRELESS to MDS app (Windows, Android, iOS, MacOS); WIRELESS HID, WIRELESS HID+MAC, USB HID
- Calibration certificate included (ISO17025 (Ilac MRA))



Item No	Range	Resolut.	Accu- racy	2D connection	Measuring HUB	Graphic	Analog scale	Preset	Go/NoGo	Max/Min	Formula	Timer	Temp comp	Linear corr	Calibr date	Recharge	Memory	WIRELESS	USB	
	mm	mm	µm																	
144303271	0-300		±15	•	•	•	•	•	•	•	•	•	•	•	•	•	•	•	•	•
144306271	0-600	<b>0,001</b>	±20	•	•	•	•	•	•	•	•	•	•	•	•	•	•	•	•	•
144310271	0-1000		±30	•	•	•	•	•	•	•	•	•	•	•	•	•	•	•	•	•

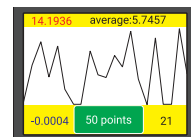

**ON-LINE GRAPHIC MODE**

**OPTIONAL ACCESSORIES**

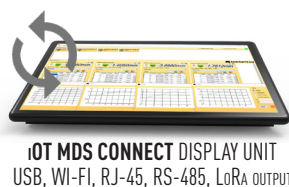

**DOWNLOAD APP**





- Industry 4.0 adopted Tablet double column micron height gauge with computerized MICS system with 3.5" color Touchscreen
- MANUAL 2D MEASURING with CONTACT or NON-CONTACT (Laser) axis
- Patents US10184772, UA144230, UA126928, UA2022050400
- Functions: On-line Graphic, Analog scale, Go/NoGo, Max/Min, Formula, Timer, Linear correction, Temperature correction
- Measuring HUB: Wireless MICROTECH instrument connection, Synchronization, 2D mode, 2D Graph, Probe mode, Compensation
- Memory manager: 2000 values, Folders system, Statistics mode, Memory data transfer
- 4 MODES DATA TRANSFER: WIRELESS to MDS app (Windows, Android, iOS, MacOS); WIRELESS HID, WIRELESS HID+MAC, USB HID
- Calibration certificate included (ISO17025 (Ilac MRA))



WIRELESS TO MDS APP  
WIRELESS HID+MAC  
USB HID

Windows Android LINUX macOS iOS

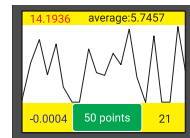

ON-LINE GRAPHIC MODE

Item No	Range		Resolut.		Accu- racy	2D connection	Measuring HUB	Graphic	Analog scale	Preset	Go/NoGo	Max/Min	Formula	Timer	Memory	WIRELESS	USB	
	Z	X	Z	X														
	mm	mm	mm	mm														
144303371	0-300	0-25	0,001	0,0001	±15	•	•	•	•	•	•	•	•	•	Folders / 2000 val	Long range / HID	USB HID / Update	
144306371	0-600				±20	•	•	•	•	•	•	•	•	•				•
144306372		0-50			•	•	•	•	•	•	•	•	•	•				
144310371	0-25	•			•	•	•	•	•	•	•	•	•	•				
144310372	0-1000	0-50			•	•	•	•	•	•	•	•	•	•				•
144310373	0-100	0-100			•	•	•	•	•	•	•	•	•	•				•

DOWNLOAD APP

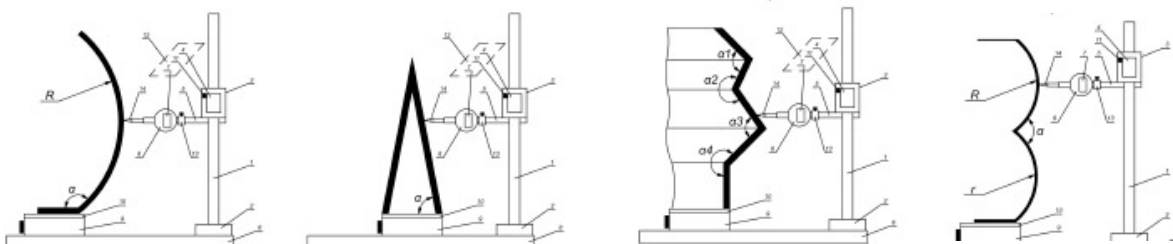

- Industry 4.0 adopted Tablet double column micron height gauge with computerized MICS system with 3.5" color Touchscreen
- Touch-trigger Probe (Standard or Precision modification)
- Interchangeable stylus
- Patents US10184772, UA144230, UA126928, UA2022050400
- Functions: On-line Graphic, Analog scale, Go/NoGo, Max/Min, Formula, Timer, Linear correction, Temperature correction
- Measuring HUB: Wireless MICROTECH instrument connection, Synchronization, 2D mode, 2D Graph, Probe mode, Compensation
- Memory manager: 2000 values, Folders system, Statistics mode, Memory data transfer
- **4 MODES DATA TRANSFER:** WIRELESS to MDS app (Windows, Android, iOS, MacOS); WIRELESS HID, WIRELESS HID+MAC, USB HID
- Calibration certificate included (ISO17025 (Iac MRA))



STANDARD TOUCH PROBE TTP-01  
**3D TOUCH**  
5 AXIS TOUCH



WIRELESS TO MDS APP  
WIRELESS HID+MAC  
USB HID



MEASURING HUB  
MICROTECH DEVICES CONNECT



Item No	Range	Resolut.	Accur.	Touch Probe	Stylus		2D connection	Measuring HUB	Graphic	Analog scale	Preset	Go/NoGo	Max/Min	Formula	Timer	Temp comp	Linear corr	Calibr date	Memory	WIRELESS	USB			
	mm	mm	µm																					
144303281	20-320		±10	TTP-01	D2mm L22mm	steel	•	•	•	•	•	•	•	•	•	•	•	•	•	•	•	•		
144306281	20-620	<b>0,001</b>	±15				•	•	•	•	•	•	•	•	•	•	•	•	•	•	•	•	•	•
144310281	20-1020		±20				•	•	•	•	•	•	•	•	•	•	•	•	•	•	•	•	•	•

**OPTIONAL ACCESSORIES**

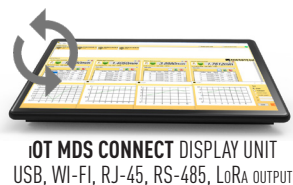

**DOWNLOAD APP**



- Industry 4.0 adopted Motorized Tablet micron height gauge with computerized MICS system with 3.5" color Touchscreen
- Motorized column and Granite base
- Touch-trigger Probe TTP-03
- Interchangeable stylus
- External display with motorized column operating, indication, data output
- Patents US10184772, UA144230, UA126928, UA2022050400
- Functions: On-line Graphic, Analog scale, Go/NoGo, Max/Min, Formula, Timer, Linear correction, Temperature correction
- Measuring HUB: Wireless MICROTECH instrument connection, Synchronization, 2D mode, 2D Graph, Probe mode, Compensation
- Memory manager: 2000 values, Folders system, Statistics mode, Memory data transfer
- **4 MODES DATA TRANSFER:** WIRELESS to MDS app (Windows, Android, iOS, MacOS); WIRELESS HID, WIRELESS HID+MAC, USB HID
- Calibration certificate included (ISO17025 (Ilac MRA))

## EXTERNAL DISPLAY

- MOTORIZED COLUMN OPERATING
- MULTI-TOUCH FOR IMPROVING ACCURACY
- GRAPHIC MODE
- GEOMETRIC MEASURING
- PROGRAMMABLE MEASURINGS



PRECISION TOUCH PROBE TTP-03  
**3D TOUCH**  
5 AXIS TOUCH

↑  
MOTORIZED  
↓

WIRELESS TO MDS APP  
WIRELESS HID+MAC  
USB HID



MEASURING HUB  
MICROTECH DEVICES CONNECT

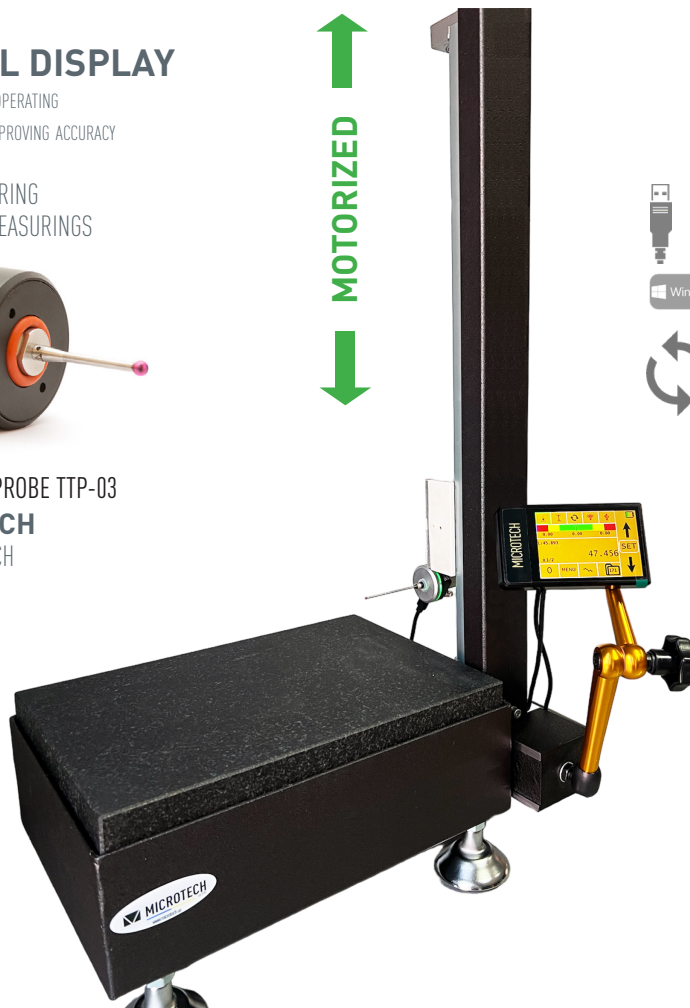

MOTORIZED  
WITH AUTO MODE

## CUSTOM RANGE AND GRANITE BASE SIZE FOR REQUEST

Item No	Range Z axis	Resolut.	Accur.	Granite base	Touch Probe	Stylus	2D connection	Measuring HUB	Graphic	Analog scale	Preset	Go/NoGo	Max/Min	Formula	Timer	Temp comp	Linear corr	Calibr date	Recharge	Memory	WIRELESS	USB	
	mm																						mm
144304278	0-400		±5				•	•	•	•	•	•	•	•	•	•	•	•	•	•	•	•	•
144307278	0-700	<b>0,0001</b>	±8	300x200	TTP-03	D4mm L22mm	ruby	•	•	•	•	•	•	•	•	•	•	•	•	•	•	•	•
144311278	0-1000		±12					•	•	•	•	•	•	•	•	•	•	•	•	•	•	•	•

- Industry 4.0 adopted sub-micron micrometer with computerized MICS system with 2,4" color Touchscreen
- **WIDE RANGE (50mm) with NON-ROTATING SPINDLE**
- **SWISS** reading system
- **Functions:** Go/NoGo, Max/Min, Formula, Timer, Linear correction, Temperature correction, Resolution selecting, Connection indication
- **Memory manager:** 2000 values, Folders system, Statistics mode, Memory data transfer
- **4 MODES DATA TRANSFER:** WIRELESS to MDS app (Windows, Android, iOS, MacOS); WIRELESS HID, WIRELESS HID+MAC, USB HID
- Top quality Aluminium housing and handle (CNC machined solid block)
- Calibration certificate included (ISO17025 (Ilac MRA))

**NON-ROTATING  
0-50MM RANGE**

MEASURING HUB  
MICROTECH DEVICES CONNECT



WIRELESS TO MDS APP  
WIRELESS HID+MAC  
USB HID

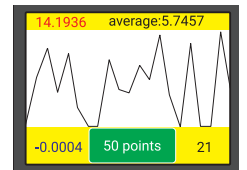
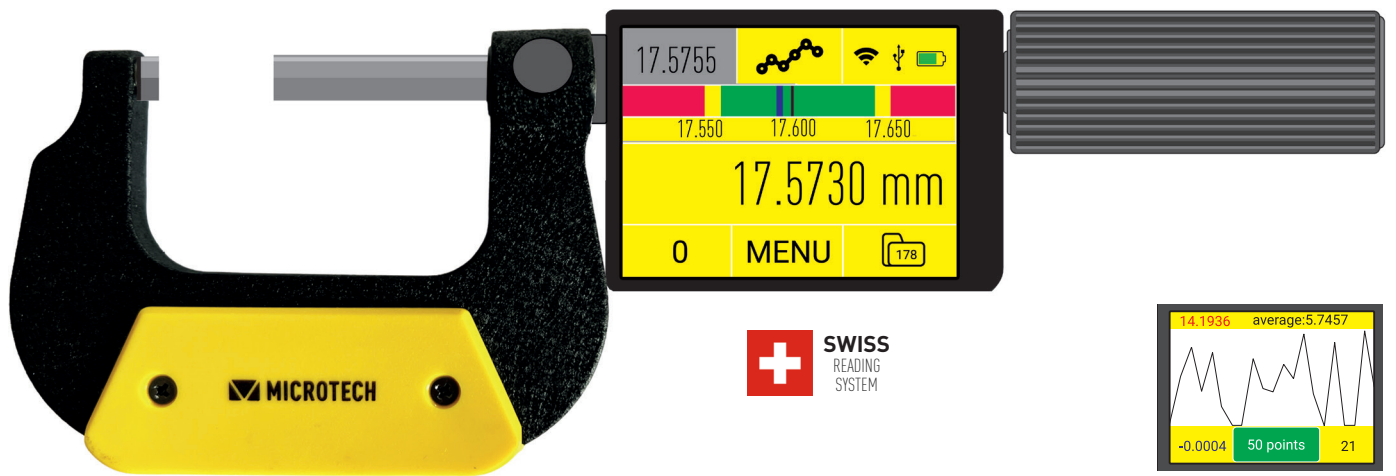

**ON-LINE  
GRAPHIC MODE**



RELEASE MARCH 2025

Item No	Range	Resolution	Accuracy	Repeat-ability	Measuring HUB	Graphic	Analog scale	Preset	Go/NoGo	Max/Min	Formula	Timer	Temp comp	Linear corr	Calibr date	Recharge	Memory	WIRELESS	USB		
																				mm	µm
110170519	0-50	0,0005	±2	0,5	•	•	•	•	•	•	•	•	•	•	•	•	•	•	•		
110171019	50-100		±3		•	•	•	•	•	•	•	•	•	•	•	•	•	•	•	•	
110171519	100-150		±3	1,0	•	•	•	•	•	•	•	•	•	•	•	•	•	•	•	•	
110172019	150-200		±4		•	•	•	•	•	•	•	•	•	•	•	•	•	•	•	•	•
110172519	200-250		±4		•	•	•	•	•	•	•	•	•	•	•	•	•	•	•	•	•
110173019	250-300		±5		•	•	•	•	•	•	•	•	•	•	•	•	•	•	•	•	•
110173519	300-350		±5		•	•	•	•	•	•	•	•	•	•	•	•	•	•	•	•	•
110174019	350-400		±5		•	•	•	•	•	•	•	•	•	•	•	•	•	•	•	•	•
110174519	400-450		±6		•	•	•	•	•	•	•	•	•	•	•	•	•	•	•	•	•
110175019	450-500		±6		•	•	•	•	•	•	•	•	•	•	•	•	•	•	•	•	•

OPTIONAL ACCESSORIES

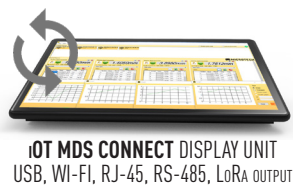

DOWNLOAD APP



- Industry 4.0 adopted sub-micron micrometer with computerized MICS system with 2,4" color Touchscreen
- **WIDE RANGE (40mm) with NON-ROTATING SPINDLE**
- Functions: Go/NoGo, Max/Min, Formula, Timer, Linear correction, Temperature correction, Resolution selecting, Connection indication
- Memory manager: 2000 values, Folders system, Statistics mode, Memory data transfer
- **4 MODES DATA TRANSFER:** WIRELESS to MDS app (Windows, Android, iOS, MacOS); WIRELESS HID, WIRELESS HID+MAC, USB HID
- Top quality Aluminium housing and handle (CNC machined solid block)
- Calibration certificate included (ISO17025 (Ilac MRA))

## NON-ROTATING

MEASURING HUB  
MICROTECH DEVICES CONNECT



WIRELESS TO MDS APP  
WIRELESS HID+MAC  
USB HID

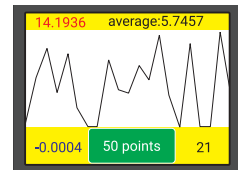

ON-LINE GRAPHIC MODE

Item No	Range	Resolution	Accuracy	Repeat-ability	Measuring HUB	Graphic	Analog scale	Preset	Go/NoGo	Max/Min	Formula	Timer	Temp comp	Linear corr	Calibr date	Recharge	Memory	WIRELESS	USB
	mm	mm	µm	µm															
110170409	0-40	0,001	±2	0,5	•	•	•	•	•	•	•	•	•	•	•	•	•	•	•

## OPTIONAL ACCESSORIES

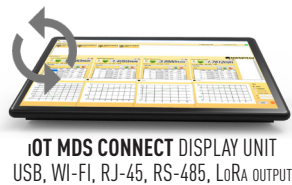

## DOWNLOAD APP



- Industry 4.0 adopted sub-micron Tablet micrometer with computerized MICS system with 2.4" color Touchscreen
- Patents UA126928, UA99686, UA2022050400
- Functions: On-line Graphic, Analog scale, Go/NoGo, Max/Min, Formula, Timer, Linear correction, Temperature correction
- Measuring HUB: Wireless MICROTECH instrument connection, Synchronization, 2D mode, 2D Graph, Probe mode, Compensation
- Memory manager: 2000 values, Folders system, Statistics mode, Memory data transfer
- **4 MODES DATA TRANSFER:** WIRELESS to MDS app (Windows, Android, iOS, MacOS); WIRELESS HID, WIRELESS HID+MAC, USB HID
- Top quality Aluminium housing (CNC machined solid block)
- Calibration certificate included (ISO17025 (Ilac MRA))

MEASURING HUB  
MICROTECH DEVICES CONNECT



WIRELESS TO MDS APP  
WIRELESS HID+MAC  
USB HID



0,1 μm

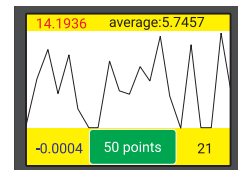

**ON-LINE GRAPHIC MODE**

Item No	Range		Reso- lution	Accu- racy	Repea- tability	Measuring HUB	Graphic	Analog scale	Preset	Go/NoGo	Max/Min	Formula	Timer	Temp comp	Linear corr	Calibr date	Recharge	Memory	WIRELESS	USB		
	mm	inch																			mm	μm
110180259	0-25	0-1"	0,0001	±1,0	0,5	•	•	•	•	•	•	•	•	•	•	•	•	•	•	•	•	
110180509	25-50	1-2"		±1,3	0,5	•	•	•	•	•	•	•	•	•	•	•	•	•	•	•	•	•
110180759	50-75	2-3"		±1,5	0,8	•	•	•	•	•	•	•	•	•	•	•	•	•	•	•	•	•
110181009	75-100	3-4"		±1,8	0,8	•	•	•	•	•	•	•	•	•	•	•	•	•	•	•	•	•
110181259	100-125	4-5"		±2,3	1,0	•	•	•	•	•	•	•	•	•	•	•	•	•	•	•	•	•
110181509	125-150	5-6"		±2,5	1,0	•	•	•	•	•	•	•	•	•	•	•	•	•	•	•	•	•
110181759	150-175	6-7"		±3,0	1,0	•	•	•	•	•	•	•	•	•	•	•	•	•	•	•	•	•
110182009	175-200	7-8"		±3,0	1,0	•	•	•	•	•	•	•	•	•	•	•	•	•	•	•	•	•
110182259	200-225	8-9"		±3,0	1,0	•	•	•	•	•	•	•	•	•	•	•	•	•	•	•	•	•
110182509	225-250	9-10"		±3,0	1,0	•	•	•	•	•	•	•	•	•	•	•	•	•	•	•	•	•
110182759	250-275	10-11"		±3,0	1,0	•	•	•	•	•	•	•	•	•	•	•	•	•	•	•	•	•
110183009	275-300	11-12"		±3,0	1,0	•	•	•	•	•	•	•	•	•	•	•	•	•	•	•	•	•
110183509	300-350	12-14"		±4,5	1,0	•	•	•	•	•	•	•	•	•	•	•	•	•	•	•	•	•
110183909	350-400	14-16"		±5,0	1,0	•	•	•	•	•	•	•	•	•	•	•	•	•	•	•	•	•

**TABLET MICROMETER SETS**

110181119	0-100	0-4"	TABLET micrometer - 4pcs; Setting rods -3pcs																		
110181519	0-150	0-6"	TABLET micrometer - 6pcs; Setting rods -5pcs																		
110182119	0-200	0-8"	TABLET micrometer - 8pcs; Setting rods -7pcs																		
110183119	0-300	0-12'	TABLET micrometer - 12pcs; Setting rods -11pcs																		
110184119	0-400	0-16"	TABLET micrometer - 14pcs; Setting rods -13pcs																		

DOWNLOAD APP



- Industry 4.0 adopted sub-micron micrometer with computerized MICS system with 1,54" color Touchscreen
- Functions: Go/NoGo, Max/Min, Formula, Timer, Linear correction, Temperature correction, Resolution selecting, Connection indication
- Memory manager: 2000 values, Folders system, Statistics mode, Memory data transfer
- **4 MODES DATA TRANSFER:** WIRELESS to MDS app (Windows, Android, iOS, MacOS); WIRELESS HID, WIRELESS HID+MAC, USB HID
- Top quality Aluminium housing (CNC machined solid block)
- Calibration certificate included (ISO17025 (Ilac MRA))



Item No	Range		Reso- lution	Accu- racy	Repeat- ability	Preset	Go/NoGo	Max/Min	Formula	Timer	Temp comp	Linear corr	Calibr date	Recharge	Memory	WIRELESS	USB
	mm	inch															
110180258	0-25	0-1"	0,0001	±1,5	0,5	•	•	•	•	•	•	•	•	•	•	•	•
110180508	25-50	1-2"		±1,6	0,5	•	•	•	•	•	•	•	•	•	•	•	•
110180758	50-75	2-3"		±1,8	0,8	•	•	•	•	•	•	•	•	•	•	•	•
110181008	75-100	3-4"		±2,0	0,8	•	•	•	•	•	•	•	•	•	•	•	•
110181258	100-125	4-5"		±2,5	1,0	•	•	•	•	•	•	•	•	•	•	•	•
110181508	125-150	5-6"		±3,0	1,0	•	•	•	•	•	•	•	•	•	•	•	•
110181758	150-175	6-7"		±3,5	1,0	•	•	•	•	•	•	•	•	•	•	•	•
110182008	175-200	7-8"		±3,5	1,0	•	•	•	•	•	•	•	•	•	•	•	•
110182258	200-225	8-9"		±4,0	1,0	•	•	•	•	•	•	•	•	•	•	•	•
110182508	225-250	9-10"		±4,0	1,0	•	•	•	•	•	•	•	•	•	•	•	•
110182758	250-275	10-11"		±4,0	1,0	•	•	•	•	•	•	•	•	•	•	•	•
110183008	275-300	11-12"		±4,0	1,0	•	•	•	•	•	•	•	•	•	•	•	•

### OPTIONAL ACCESSORIES

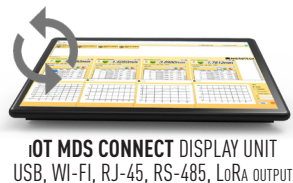

### DOWNLOAD APP



- **Industry 4.0** adopted sub-micron Tablet micrometer with computerized MICS system with 2.4" color Touchscreen
- Bench configuration for laboratory using
- **Functions:** On-line Graphic, Analog scale, Go/NoGo, Max/Min, Formula, Timer, Linear correction, Temperature correction
- **Measuring HUB:** Wireless MICROTECH instrument connection, Synchronization, 2D mode, 2D Graph, Probe mode, Compensation
- **Memory manager:** 2000 values, Folders system, Statistics mode, Memory data transfer
- **4 MODES DATA TRANSFER:** WIRELESS to MDS app (Windows, Android, iOS, MacOS); WIRELESS HID, WIRELESS HID+MAC, USB HID
- Top quality Aluminium housing (CNC machined solid block)
- **Calibration** certificate included (ISO17025 (Ilac MRA))

**MEASURING HUB**  
MICROTECH DEVICES CONNECT



WIRELESS TO MDS APP  
WIRELESS HID+MAC  
USB HID



0,1µm

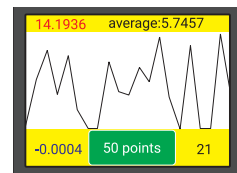

**ON-LINE GRAPHIC MODE**

Item No	Range				Resol.	Accur.	Non-rotating	Measuring HUB	Graphic	Analog scale	Preset	Go/NoGo	Max/Min	Formula	Timer	Temp comp	Linear corr	Calibr date	Recharge	Memory	WIRELESS	USB	
	Stand		Micrometer head																				
	mm	inch	mm	inch																			
110180278	0-25	0-1"	0-25	0-1"	0,0001	±1.0	•	•	•	•	•	•	•	•	•	•	•	•	•	•	•	•	•
110180288						±1.3	•	•	•	•	•	•	•	•	•	•	•	•	•	•	•	•	•
110180578	0-50	0-2"	0-50	0-2"	0,0005	±1.5	•	•	•	•	•	•	•	•	•	•	•	•	•	•	•	•	•
110180588						±2,0	•	•	•	•	•	•	•	•	•	•	•	•	•	•	•	•	•

**OPTIONAL ACCESSORIES**



**IoT MDS CONNECT DISPLAY UNIT**  
USB, WI-FI, RJ-45, RS-485, LoRa OUTPUT



**IoT DATA BUTTON**



**MICROMETER STAND**

**DOWNLOAD APP**





# WIDE RANGE SUB-MICRON MICROMETER WITH INTERCHANGEABLE ANVILS

- Industry 4.0 adopted sub-micron WIDE range micrometer with computerized MICS system with 2.4" color Touchscreen
- Interchangeable anvils (5pcs) for Wide measuring range 150mm
- Functions: On-line Graphic, Analog scale, Go/NoGo, Max/Min, Formula, Timer, Linear correction, Temperature correction
- Measuring HUB: Wireless MICROTECH instrument connection, Synchronization, 2D mode, 2D Graph, Probe mode, Compensation
- Memory manager: 2000 values, Folders system, Statistics mode, Memory data transfer
- **4 MODES DATA TRANSFER:** WIRELESS to MDS app (Windows, Android, iOS, MacOS); WIRELESS HID, WIRELESS HID+MAC, USB HID
- Top quality Aluminium housing (CNC machined solid block)
- Calibration certificate included (ISO17025 (Ilac MRA))

0,1µm

MEASURING HUB  
MICROTECH DEVICES CONNECT

WIRELESS TO MDS APP  
WIRELESS HID+MAC  
USB HID

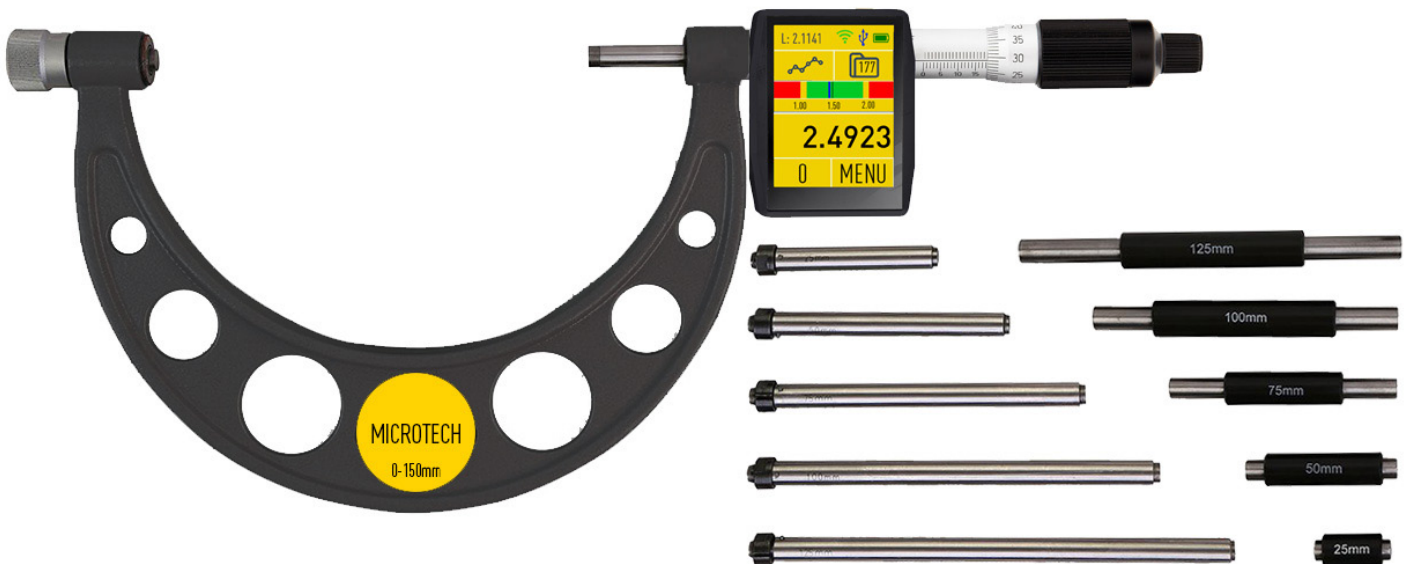

Item No	Range		Micro-meter head range	Reso-lution	Accu-racy	Repeat-ability	Anvils	Setting rods	Measuring HUB	Graphic	Analog scale	Preset	Go/NoGo	Max/Min	Formula	Timer	Temp comp	Linear corr	Calibr date	Recharge	Memory	WIRELESS	USB
	mm	inch																					
110181539	0-150	0-2"	25	0,0001	±3.5	1	5	5	•	•	•	•	•	•	•	•	•	•	•	•	•	•	•
110183039	150-300	2-4"			±4	1	5	5	•	•	•	•	•	•	•	•	•	•	•	•	•	•	•

## OPTIONAL ACCESSORIES



IoT MDS CONNECT DISPLAY UNIT  
USB, WI-FI, RJ-45, RS-485, LoRa OUTPUT



IoT DATA BUTTON



MICROMETER STAND

## DOWNLOAD APP



- High accuracy up to  $\pm 2\mu\text{m}$  (in 2 times better than DIN 863-1)
- Friction thimble micrometer head
- Functions: mm/inch, origin, hold
- Aluminium housing with IP65 protection
- **Calibration** certificate included (ISO17025 (Iac MRA))



Item No	Range		Reso- lution		Accu- racy		Anvil D	Protection	mm/ inch	ABS/ INC	HOLD
	mm	inch	mm	$\mu\text{m}$	mm						
110180254	0-25	0-1"	0,001	$\pm 2$	6.5	IP65	•	•	•		
110180504	25-50	1-2"		$\pm 2$			•	•	•		
110180754	50-75	2-3"		$\pm 2$			•	•	•		
110181004	75-100	3-4"		$\pm 3$			•	•	•		
110181254	100-125	4-5"		$\pm 4$			•	•	•		
110181504	125-150	5-6"		$\pm 4$			•	•	•		
110181754	150-175	6-7"		$\pm 4$			•	•	•		
110182004	175-200	7-8"		$\pm 4$			•	•	•		
110182254	200-225	8-9"		$\pm 5$			•	•	•		
110182504	225-250	9-10"		$\pm 5$			•	•	•		
110182754	250-275	10-11"		$\pm 5$			•	•	•		
110183004	275-300	11-12"		$\pm 5$			•	•	•		
110183504	300-350	12-14"		$\pm 7$			•	•	•		
110183904	350-400	14-16"		$\pm 8$			•	•	•		

**DIGITAL MICROMETER SET**

110181114	0-100	0-4"	DIGITAL micrometer - 4pcs;
110181514	0-150	0-6"	DIGITAL micrometer - 6pcs;
110182114	0-200	0-8"	DIGITAL micrometer - 8pcs;
110183114	0-300	0-12"	DIGITAL micrometer - 12pcs;
110184114	0-400	0-16"	DIGITAL micrometer - 14pcs;

**OPTIONAL ACCESSORIES**



**MICROMETER STAND**

## NON-ROTATING DIGITAL MICROMETER IP65

- High accuracy up to  $\pm 2\mu\text{m}$  (in 2 times better than DIN 863-1)
- Friction thimble micrometer head
- Non-rotating spindle
- Functions: mm/inch, origin, hold
- Aluminium housing with IP65 protection
- **Calibration** certificate included (ISO17025 (Ilac MRA))



Item No	Range		Reso- lution	Accu- racy	Anvil D	Protection	mm/inch	ABS/INC	HOLD
	mm	inch	mm	$\mu\text{m}$	mm				
110170254	0-25	0-1"	0,001	$\pm 2$	7.5	IP65	•	•	•
110170504	25-50	1-2"		$\pm 2$			•	•	•

## DOUBLE RANGE DIGITAL MICROMETER IP65

- DOUBLE measuring range
- Friction thimble micrometer head
- Functions: mm/inch, origin, hold
- Aluminium housing with IP65 protection
- **Calibration** certificate included (ISO17025 (Ilac MRA))



Item No	Range		Reso- lution	Accu- racy	Anvil D	Protection	mm/inch	ABS/INC	HOLD
	mm	inch	mm	$\mu\text{m}$	mm				
110180514	0-50	0-2"	0,001	$\pm 3$	6.5	IP65	•	•	•
110181014	50-100	2-4"		$\pm 4$			•	•	•
<b>DIGITAL MICROMETER SET</b>									
110181124	0-100	0-4"	TABLET micrometer - 2pcs;						

### OPTIONAL ACCESSORIES



MICROMETER STAND

- High accuracy up to  $\pm 2\mu\text{m}$  (in 2 times better than DIN 863-1)
- Ratchet stop micrometer head
- Calibration certificate included (ISO17025 (Ilac MRA))



Item No	Range	Reso- lution	Accu- racy	Anvil D
	mm			
110110251	0-25	0,01	$\pm 2$	6.5
110110501	25-50		$\pm 2$	
110110751	50-75		$\pm 3$	
110111001	75-100		$\pm 3$	
110111251	100-125		$\pm 4$	
110111501	125-150		$\pm 4$	
110111751	150-175		$\pm 4$	
110112001	175-200		$\pm 4$	
110112251	200-225		$\pm 5$	
110112501	225-250		$\pm 5$	
110112751	250-275		$\pm 5$	
110113001	275-300		$\pm 5$	
OUTSIDE MICROMETER SET				
110110111	0-100	4 pcs in set		
110110151	0-150	6 pcs in set		
110110311	0-300	12 pcs in set		



- High accuracy up to  $\pm 2\mu\text{m}$  (in 2 times better than DIN 863-1)
- Friction thimble micrometer head
- 1 micron resolution
- Calibration certificate included (ISO17025 (Ilac MRA))



Item No	Range	Reso- lution	Accu- racy	Anvil D
	mm			
110110250	0-25	0,001	$\pm 2$	6.5
110110500	25-50		$\pm 2$	
110110750	50-75		$\pm 3$	
110111000	75-100		$\pm 3$	
MICRON OUTSIDE MICROMETER SET				
110110110	0-100	4 pcs in set		

- Wide range digital micrometers with range up to 3 m
- Digital micrometer head with IP65 proof
- Setting rods included
- **Calibration** certificate included (ISO17025 (Iac MRA))

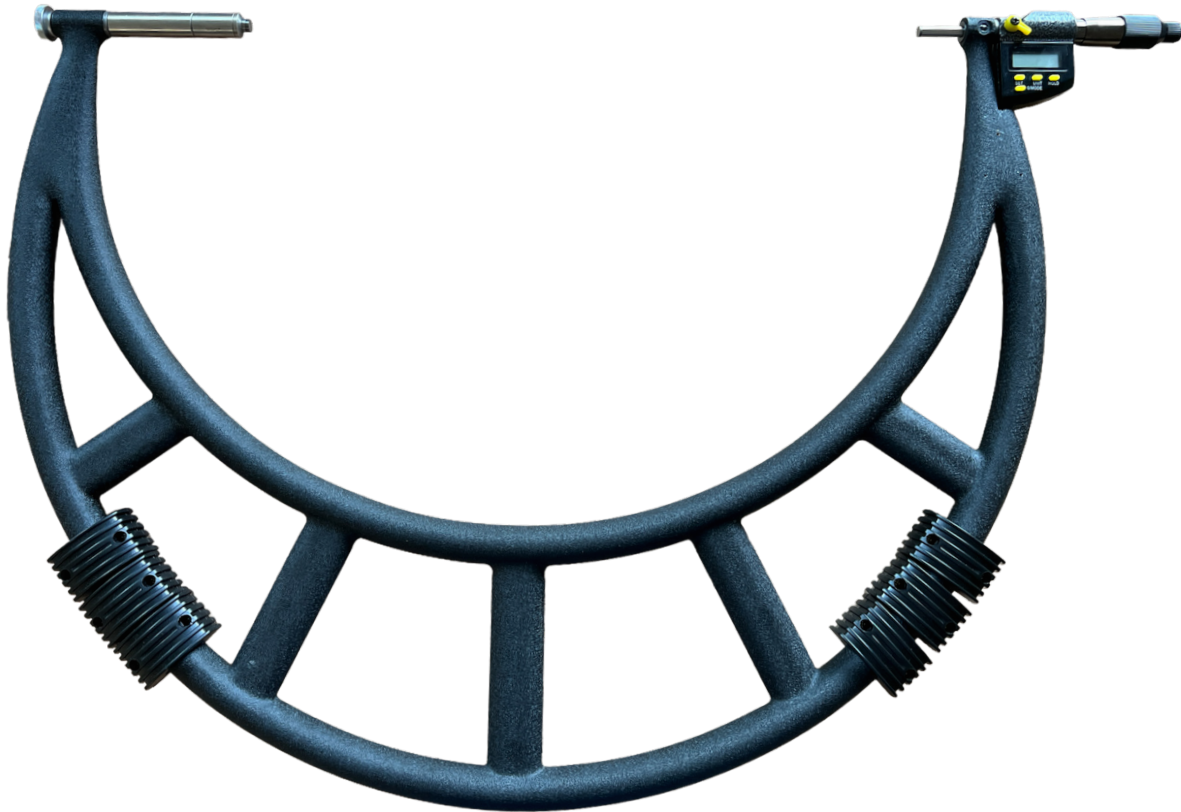

Item No	Range		Resol.	Accuracy	Micrometer head range	Weight	Setting rod
	mm	inch					
110174001	300-400	12-15"	0,001	±7	25	1,9	•
110175001	400-500	15-20"		±7		2,2	•
110176001	500-600	20-24"		±8		2,6	•
110177001	600-700	24-28"		±8		2,9	•
110178001	700-800	28-32"		±15		4,8	•
110179001	800-900	32-36"		±15		5,5	•
110171101	900-1000	36-40"		±15	6,7	•	
110171201	1000-1200	40-48"		±18	9,2	•	
110171401	1200-1400	48-56"		±20	11,0	•	
110171601	1400-1600	56-64"		±25	13,3	•	
110171801	1600-1800	64-72"		±30	16,2	•	
110172001	1800-2000	72-80"		±35	19,5	•	
110172201	2000-2200	80-88"		±40	25	•	
110172401	2200-2400	88-96"		±45	27	•	
110172601	2400-2600	96-104"		±50	28,5	•	
110172801	2600-2800	104-112"	±55	30,5	•		
110173101	2800-3000	112-120"	±60	33	•		



- Wide range micrometers with range up to 3 m
- Patents UA108044, UA99686, UA2022050400
- Computerized **MICS** indication system Modification with **Long range** Wireless, Wireless HID or USB HID data transfer to Windows, Android, iOS, macOS, Linux systems direct to any app.
- Setting rods included
- **Calibration** certificate included (ISO17025 (Ilac MRA))

**MEASURING HUB**  
MICROTECH DEVICES CONNECT



**WIRELESS TO MDS APP**  
**WIRELESS HID+MAC**  
**USB HID**

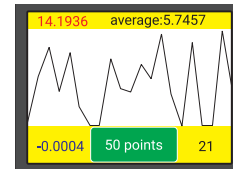
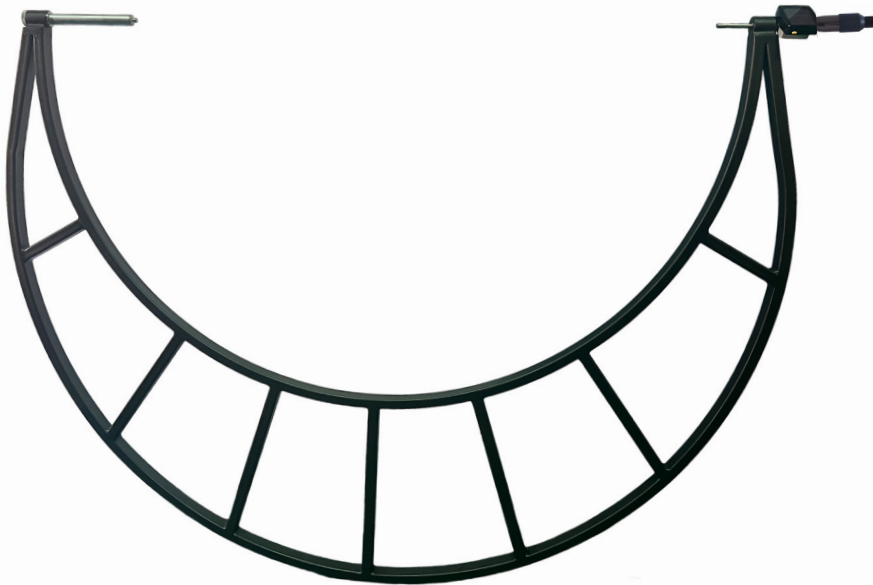

**ON-LINE**  
**GRAPHIC MODE**

Item No	Range		Resol.	Accuracy	Micro-meter head range	Weight	Setting rod	Measuring HUB	Graphic	Analog scale	Preset	Go/NoGo	Max/Min	Formula	Timer	Temp comp	Linear corr	Calibr date	Recharge	2D Sync	Memory	WIRELESS	USB		
	mm	inch																						mm	µm
110184008	300-400	12-15"	0,0001	±5	25	1,9	•	•	•	•	•	•	•	•	•	•	•	•	•	•	•	•	•		
110185008	400-500	15-20"		±5		2,2	•	•	•	•	•	•	•	•	•	•	•	•	•	•	•	•	•	•	•
110186008	500-600	20-24"		±6		2,6	•	•	•	•	•	•	•	•	•	•	•	•	•	•	•	•	•	•	•
110187008	600-700	24-28"		±7		2,9	•	•	•	•	•	•	•	•	•	•	•	•	•	•	•	•	•	•	•
110188008	700-800	28-32"		±8		4,8	•	•	•	•	•	•	•	•	•	•	•	•	•	•	•	•	•	•	•
110189008	800-900	32-36"		±10		5,5	•	•	•	•	•	•	•	•	•	•	•	•	•	•	•	•	•	•	•
110181108	900-1000	36-40"		±10		6,7	•	•	•	•	•	•	•	•	•	•	•	•	•	•	•	•	•	•	•
110181208	1000-1200	40-48"		±14		9,2	•	•	•	•	•	•	•	•	•	•	•	•	•	•	•	•	•	•	•
110181408	1200-1400	48-56"		±16	11,0	•	•	•	•	•	•	•	•	•	•	•	•	•	•	•	•	•	•	•	
110181608	1400-1600	56-64"		±20	13,3	•	•	•	•	•	•	•	•	•	•	•	•	•	•	•	•	•	•	•	
110181808	1600-1800	64-72"		±24	16,2	•	•	•	•	•	•	•	•	•	•	•	•	•	•	•	•	•	•	•	
110182008	1800-2000	72-80"		±30	19,5	•	•	•	•	•	•	•	•	•	•	•	•	•	•	•	•	•	•	•	
110182208	2000-2200	80-88"		±33	25	•	•	•	•	•	•	•	•	•	•	•	•	•	•	•	•	•	•	•	
110182408	2200-2400	88-96"		±36	27	•	•	•	•	•	•	•	•	•	•	•	•	•	•	•	•	•	•	•	
110182608	2400-2600	96-104"		±40	28,5	•	•	•	•	•	•	•	•	•	•	•	•	•	•	•	•	•	•	•	
110182808	2600-2800	104-112"		±42	30,5	•	•	•	•	•	•	•	•	•	•	•	•	•	•	•	•	•	•	•	
110183108	2800-3000	112-120"	±45	33	•	•	•	•	•	•	•	•	•	•	•	•	•	•	•	•	•	•	•		

**OPTIONAL ACCESSORIES**

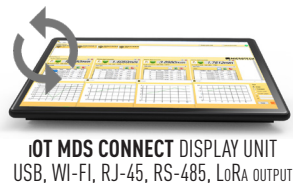

**DOWNLOAD APP**



- Wide range micrometers with range up to 10 m
- Patented Modular construction for easy transportation (assembling 15 minutes)
- Patents UA108044, UA99686, UA2022050400
- Computerized **MICS** indication system Modification with **Long range Wireless**, **Wireless HID** or **USB HID** data transfer to Windows, Android, iOS, macOS, Linux systems direct to any app.
- Setting rods included
- **Calibration** certificate included (ISO17025 (Ilac MRA))

MEASURING HUB  
MICROTECH DEVICES CONNECT



WIRELESS TO MDS APP  
WIRELESS HID+MAC  
USB HID

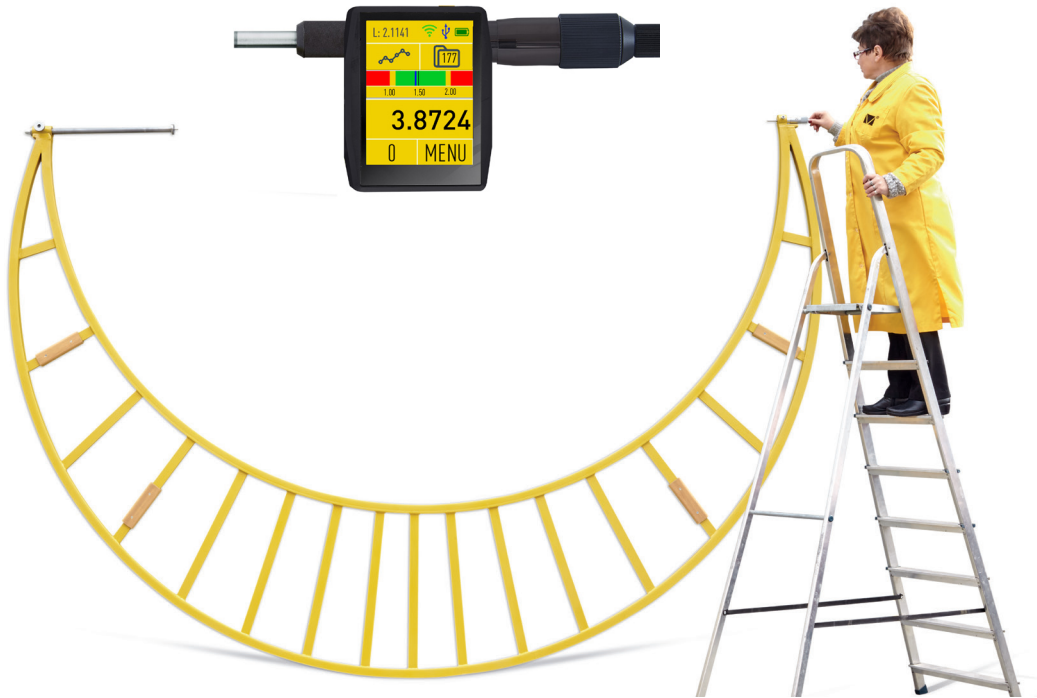

## CUSTOM RANGE AND GAUGE CONFIGURATION FOR REQUEST

Item No	Range	Resol.	Accur.	Modules	Micro-meter head range	Weight	Setting rod	Measuring HUB	Graphic	Analog scale	Preset	Go/NoGo	Max/Min	Formula	Timer	Temp comp	Linear corr	Calibr date	Memory	WIRELESS	USB	
	mm	mm	µm		mm																	kg
110160155	1000-1500	0,0001	±28	2	50	18	•	•	•	•	•	•	•	•	•	•	•	•	Folders / 2000 val Long range / HID USB HID / Update			
110160205	1500-2000		±32	2		22	•	•	•	•	•	•	•	•	•	•	•	•				•
110160305	2000-3000		±50	3		35	•	•	•	•	•	•	•	•	•	•	•	•				•
110160405	3000-4000		±60	4		47	•	•	•	•	•	•	•	•	•	•	•	•				•
110160505	4000-5000		±75	5		60	•	•	•	•	•	•	•	•	•	•	•	•				•
110160605	5000-6000		±90	6		79	•	•	•	•	•	•	•	•	•	•	•	•				•
110160705	6000-7000		±105	7		95	•	•	•	•	•	•	•	•	•	•	•	•				•
110160805	7000-8000		±120	8		115	•	•	•	•	•	•	•	•	•	•	•	•				•
110160905	8000-9000		±135	9		136	•	•	•	•	•	•	•	•	•	•	•	•				•
110161005	9000-10000		±150	10		160	•	•	•	•	•	•	•	•	•	•	•	•				•

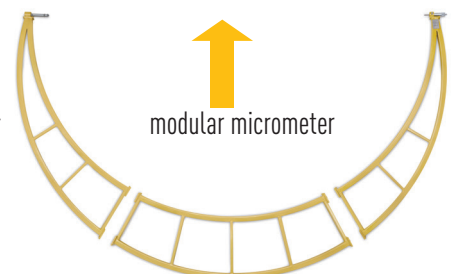

DOWNLOAD APP



## OPTIONAL ACCESSORIES



IoT MDS CONNECT DISPLAY UNIT  
USB, WI-FI, RJ-45, RS-485, LoRa OUTPUT



IoT DATA BUTTON

- Industry 4.0 adopted sub-micron Universal micrometer with computerized MICS system with 2.4" color Touchscreen
- Patents UA126928, UA99686, UA2022050400
- Functions: On-line Graphic, Analog scale, Go/NoGo, Max/Min, Formula, Timer, Linear correction, Temperature correction
- Measuring HUB: Wireless MICROTECH instrument connection, Synchronization, 2D mode, 2D Graph, Probe mode, Compensation
- Memory manager: 2000 values, Folders system, Statistics mode, Memory data transfer
- INCLUDE 7 pairs of interchangeable anvils (Flat, Spherical, Disk, Blade, Point, Spline, Knife edge). Custom anvils for request
- **4 MODES DATA TRANSFER:** WIRELESS to MDS app (Windows, Android, iOS, MacOS); WIRELESS HID, WIRELESS HID+MAC, USB HID
- Calibration certificate included (ISO17025 (Ilac MRA))

**NON-ROTATING**

MEASURING HUB  
MICROTECH DEVICES CONNECT



WIRELESS TO MDS APP  
WIRELESS HID+MAC  
USB HID



0,1µm

**UNIVERSAL ANVILS SET INCLUDES**

**7 PAIRS OF ANVILS**

Item No	Range		Resol.	Accur.	NON-ROTATING	Analog scale	Graphic	Preset	Go/NoGo	Max/Min	Formula	Timer	Temp comp	Linear corr	Calibr date	Recharge	2D Synchronize	Memory	WIRELESS	USB	
	mm	inch																			mm
110750258	0-25	0-1"	0,0001	±3	•	•	•	•	•	•	•	•	•	•	•	•	•	•	•	•	
110750508	25-50	1-2"		±3	•	•	•	•	•	•	•	•	•	•	•	•	•	•	•	•	•
110750758	50-75	2-3"		±4	•	•	•	•	•	•	•	•	•	•	•	•	•	•	•	•	•
110751008	75-100	3-4"		±4	•	•	•	•	•	•	•	•	•	•	•	•	•	•	•	•	•
110751258	100-125	4-5"		±5	•	•	•	•	•	•	•	•	•	•	•	•	•	•	•	•	•
110751508	125-150	5-6"		±5	•	•	•	•	•	•	•	•	•	•	•	•	•	•	•	•	•
110751758	150-175	6-7"		±6	•	•	•	•	•	•	•	•	•	•	•	•	•	•	•	•	•
110752008	175-200	7-8"		±7	•	•	•	•	•	•	•	•	•	•	•	•	•	•	•	•	•
110752258	200-225	8-9"		±7	•	•	•	•	•	•	•	•	•	•	•	•	•	•	•	•	•
110752508	225-250	9-10"		±8	•	•	•	•	•	•	•	•	•	•	•	•	•	•	•	•	•
110752758	250-275	10-11"		±8	•	•	•	•	•	•	•	•	•	•	•	•	•	•	•	•	•
110753008	275-300	11-12"		±8	•	•	•	•	•	•	•	•	•	•	•	•	•	•	•	•	•

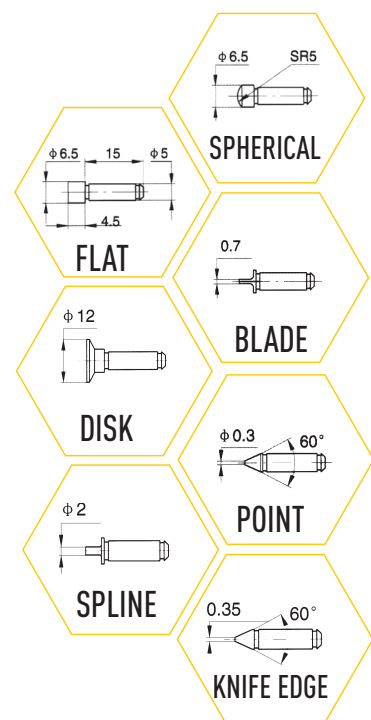

**OPTIONAL ACCESSORIES**

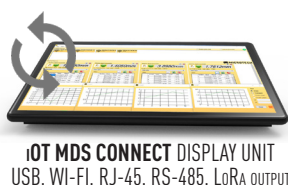



- Industry 4.0 adopted DOUBLE range Universal micrometer with computerized MICS system with 2,4" color Touchscreen
- **WIDE RANGE (50mm) with NON-ROTATING SPINDLE**
- **SWISS** reading system
- Functions: On-line Graphic, Analog scale, Go/NoGo, Max/Min, Formula, Timer, Linear correction, Temperature correction
- Measuring HUB: Wireless MICROTECH instrument connection, Synchronization, 2D mode, 2D Graph, Probe mode, Compensation
- Memory manager: 2000 values, Folders system, Statistics mode, Memory data transfer
- INCLUDE 7 pairs of interchangeable anvils (Flat, Spherical, Disk, Blade, Point, Spline, Knife edge). Custom anvils for request
- **4 MODES DATA TRANSFER:** WIRELESS to MDS app (Windows, Android, iOS, MacOS); WIRELESS HID, WIRELESS HID+MAC, USB HID
- Calibration certificate included (ISO17025 (Ilac MRA))

**NON-ROTATING  
0-50MM RANGE**

MEASURING HUB  
MICROTECH DEVICES CONNECT



WIRELESS TO MDS APP  
WIRELESS HID+MAC  
USB HID



**SWISS**  
READING  
SYSTEM



0,5µm

**UNIVERSAL ANVILS SET INCLUDES**

**RELEASE MARCH 2025**

**7 PAIRS OF ANVILS**

Item No	Range		Resol.	Accur.	NON-ROTATING	Analog scale	Graphic	Preset	Go/NoGo	Max/Min	Formula	Timer	Temp comp	Linear corr	Calibr date	Recharge	2D Synchronize	Memory	WIRELESS	USB		
	mm	inch																			mm	µm
110750509	0-50	0-2"	0,0005	±2.5	•	•	•	•	•	•	•	•	•	•	•	•	•	•	•	•	•	
110751009	50-100	2-4"		±3	•	•	•	•	•	•	•	•	•	•	•	•	•	•	•	•	•	•
110751509	100-150	4-6"		±4	•	•	•	•	•	•	•	•	•	•	•	•	•	•	•	•	•	•
110752009	150-200	6-8"		±6	•	•	•	•	•	•	•	•	•	•	•	•	•	•	•	•	•	•
110752509	200-250	8-10"		±6	•	•	•	•	•	•	•	•	•	•	•	•	•	•	•	•	•	•
110753009	250-300	10-12"		±6	•	•	•	•	•	•	•	•	•	•	•	•	•	•	•	•	•	•
																			Folders / 2000 val	Long range / HID	USB HID / Update	

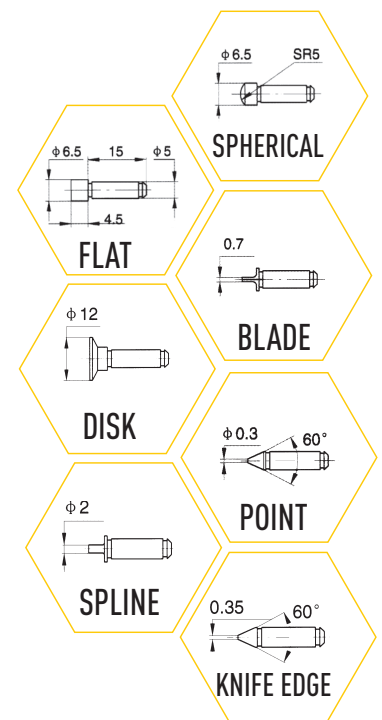

**OPTIONAL ACCESSORIES**

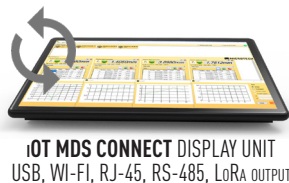

- Industry 4.0 adopted sub-micron Universal micrometer with computerized MICS system with 2.4" color Touchscreen
- Patents UA126928, UA99686, UA2022050400
- Functions: On-line Graphic, Analog scale, Go/NoGo, Max/Min, Formula, Timer, Linear correction, Temperature correction
- Measuring HUB: Wireless MICROTECH instrument connection, Synchronization, 2D mode, 2D Graph, Probe mode, Compensation
- Memory manager: 2000 values, Folders system, Statistics mode, Memory data transfer
- INCLUDE 7 pairs of interchangeable anvils (Flat, Spherical, Disk, Blade, Point, Spline, Knife edge). Custom anvils for request
- **4 MODES DATA TRANSFER:** WIRELESS to MDS app (Windows, Android, iOS, MacOS); WIRELESS HID, WIRELESS HID+MAC, USB HID
- Calibration certificate included (ISO17025 (Ilac MRA))

**NON-ROTATING**

0,1µm

MEASURING HUB  
MICROTECH DEVICES CONNECT



WIRELESS TO MDS APP  
WIRELESS HID+MAC  
USB HID



**UNIVERSAL ANVILS SET INCLUDES**

**7 PAIRS OF ANVILS**

Item No	Range		Resol.	Accur.	NON-ROTATING	Analog scale	Graphic	Preset	Go/NoGo	Max/Min	Formula	Timer	Temp comp	Linear corr	Calibr date	Recharge	2D Synchronize	Memory	WIRELESS	USB		
	mm	inch																			mm	µm
110754008	300-400	12-16"	0,0001	±10	•	•	•	•	•	•	•	•	•	•	•	•	•	•	•	•	•	
110755008	400-500	16-20"		±10	•	•	•	•	•	•	•	•	•	•	•	•	•	•	•	•	•	•
110756008	500-600	20-24"		±12	•	•	•	•	•	•	•	•	•	•	•	•	•	•	•	•	•	•
110757008	600-700	24-28"		±14	•	•	•	•	•	•	•	•	•	•	•	•	•	•	•	•	•	•
110758008	700-800	28-32"		±14	•	•	•	•	•	•	•	•	•	•	•	•	•	•	•	•	•	•
110759008	800-900	32-36"		±15	•	•	•	•	•	•	•	•	•	•	•	•	•	•	•	•	•	•
110750008	900-1000	36-40"		±15	•	•	•	•	•	•	•	•	•	•	•	•	•	•	•	•	•	•

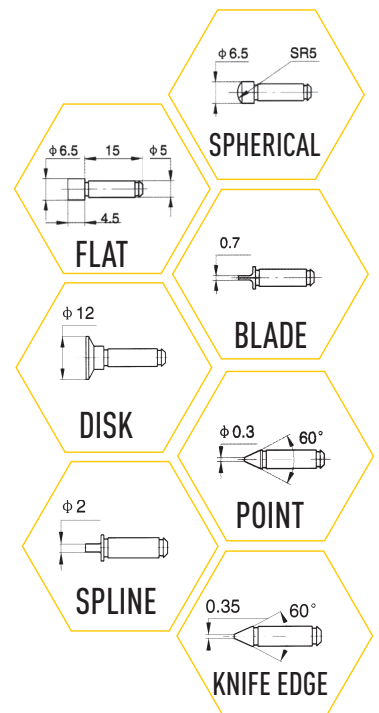

**OPTIONAL ACCESSORIES**

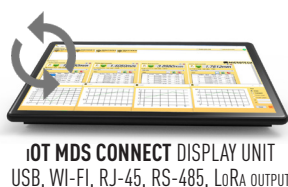

- Industry 4.0 adopted sub-micron Universal BENCH micrometer with computerized MICS system with 2.4" color Touchscreen
- Patents UA126928, UA99686, UA2022050400
- Functions: On-line Graphic, Analog scale, Go/NoGo, Max/Min, Formula, Timer, Linear correction, Temperature correction
- Measuring HUB: Wireless MICROTECH instrument connection, Synchronization, 2D mode, 2D Graph, Probe mode, Compensation
- Memory manager: 2000 values, Folders system, Statistics mode, Memory data transfer
- INCLUDE 7 pairs of interchangeable anvils (Flat, Spherical, Disk, Blade, Point, Spline, Knife edge). Custom anvils for request
- **4 MODES DATA TRANSFER:** WIRELESS to MDS app (Windows, Android, iOS, MacOS); WIRELESS HID, WIRELESS HID+MAC, USB HID
- Calibration certificate included (ISO17025 (Iac MRA))

MEASURING HUB  
MICROTECH DEVICES CONNECT



WIRELESS TO MDS APP  
WIRELESS HID+MAC  
USB HID



## NON-ROTATING

0,1µm



## UNIVERSAL ANVILS SET INCLUDES

Item No	Range		Resol.	Accur.	NON-ROTATING	Analog scale	Graphic	Preset	Go/NoGo	Max/Min	Formula	Timer	Temp comp	Linear corr	Calibr date	Recharge	Memory	WIRELESS	USB
	mm	inch	mm	µm															
110750298	0-25	0-1"	0,0001	±2	•	•	•	•	•	•	•	•	•	•	•	•	•	•	•
110750598	0-50	0-2"	0,0005	±2	•	•	•	•	•	•	•	•	•	•	•	•	•	•	•

## 7 PAIRS OF ANVILS

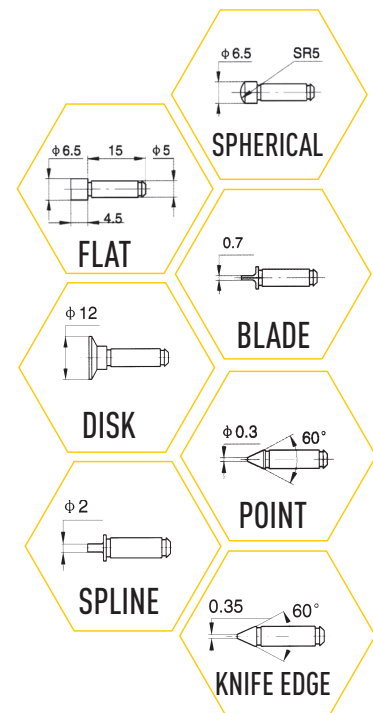

### DOWNLOAD APP



### OPTIONAL ACCESSORIES

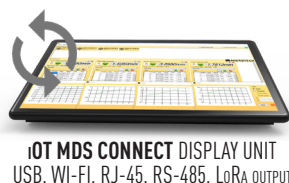

- Industry 4.0 adopted DOUBLE range Universal micrometer with computerized MICS system with 2,4" color Touchscreen
- FOR INSTALLATION UNIVERSAL, THREAD, BALL or DISK anvils (NOT INCLUDED)
- WIDE RANGE (50mm) with NON-ROTATING SPINDLE
- SWISS reading system
- Functions: On-line Graphic, Analog scale, Go/NoGo, Max/Min, Formula, Timer, Linear correction, Temperature correction
- Measuring HUB: Wireless MICROTECH instrument connection, Synchronization, 2D mode, 2D Graph, Probe mode, Compensation
- Memory manager: 2000 values, Folders system, Statistics mode, Memory data transfer
- 4 MODES DATA TRANSFER: WIRELESS to MDS app (Windows, Android, iOS, MacOS); WIRELESS HID, WIRELESS HID+MAC, USB HID
- Calibration certificate included (ISO17025 (Ilac MRA))

NON-ROTATING  
0-50MM RANGE

MEASURING HUB  
MICROTECH DEVICES CONNECT



WIRELESS TO MDS APP  
WIRELESS HID+MAC  
USB HID

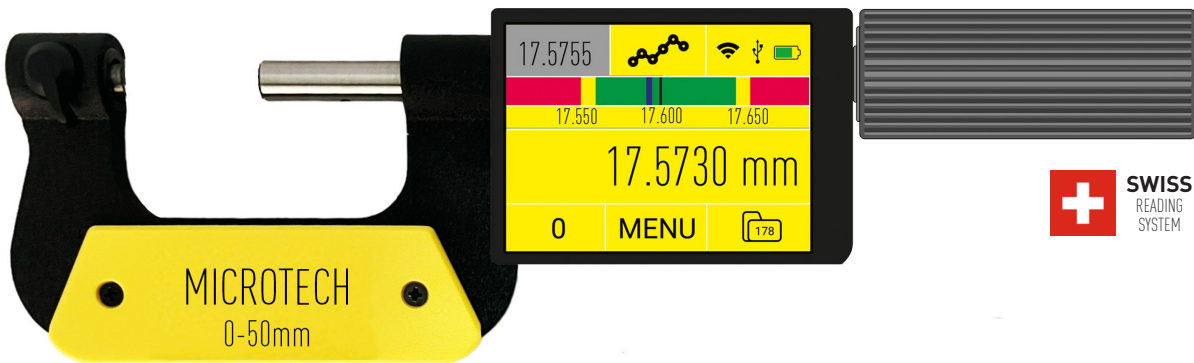

0,5µm

RELEASE MARCH 2025

Item No	Range		Resol.	Accur.	Anvils	NON-ROTATING	Analog scale	Graphic	Preset	Go/NoGo	Max/Min	Formula	Timer	Temp comp	Linear corr	Calibr date	Recharge	2D Synchronize	Memory	WIRELESS	USB			
	mm	inch																				mm	µm	
110750529	0-50	0-2"	0,0005	±2.5	ANVILS NOT INCLUDED	•	•	•	•	•	•	•	•	•	•	•	•	•	•	•	•	•		
110751029	50-100	2-4"		±3		•	•	•	•	•	•	•	•	•	•	•	•	•	•	•	•	•	•	•
110751529	100-150	4-6"		±4		•	•	•	•	•	•	•	•	•	•	•	•	•	•	•	•	•	•	•
110752029	150-200	6-8"		±5		•	•	•	•	•	•	•	•	•	•	•	•	•	•	•	•	•	•	•
110752529	200-250	8-10"		±6		•	•	•	•	•	•	•	•	•	•	•	•	•	•	•	•	•	•	•
110753029	250-300	10-12"		±6		•	•	•	•	•	•	•	•	•	•	•	•	•	•	•	•	•	•	•
110753529	300-350	12-14"		±7		•	•	•	•	•	•	•	•	•	•	•	•	•	•	•	•	•	•	•
110754029	350-400	14-16"		±7		•	•	•	•	•	•	•	•	•	•	•	•	•	•	•	•	•	•	•
110754529	400-450	16-18"		±8		•	•	•	•	•	•	•	•	•	•	•	•	•	•	•	•	•	•	•
110755029	450-500	18-20"		±8		•	•	•	•	•	•	•	•	•	•	•	•	•	•	•	•	•	•	•
110755529	500-550	20-22"		±9		•	•	•	•	•	•	•	•	•	•	•	•	•	•	•	•	•	•	•
110756029	550-600	22-24"		±9		•	•	•	•	•	•	•	•	•	•	•	•	•	•	•	•	•	•	•
110756529	600-650	24-26"		±10		•	•	•	•	•	•	•	•	•	•	•	•	•	•	•	•	•	•	•
110757029	650-700	26-28"		±10		•	•	•	•	•	•	•	•	•	•	•	•	•	•	•	•	•	•	•
110757529	700-750	28-30"		±11		•	•	•	•	•	•	•	•	•	•	•	•	•	•	•	•	•	•	•
110758029	750-800	30-32"		±11		•	•	•	•	•	•	•	•	•	•	•	•	•	•	•	•	•	•	•
110758529	800-850	32-34"		±12		•	•	•	•	•	•	•	•	•	•	•	•	•	•	•	•	•	•	•
110759029	850-900	34-36"		±12		•	•	•	•	•	•	•	•	•	•	•	•	•	•	•	•	•	•	•
110759529	900-950	36-38"		±14		•	•	•	•	•	•	•	•	•	•	•	•	•	•	•	•	•	•	•
110759929	950-1000	38-40"	±14	•	•	•	•	•	•	•	•	•	•	•	•	•	•	•	•	•	•	•		

DOWNLOAD APP



## UNIVERSAL ANVILS SET

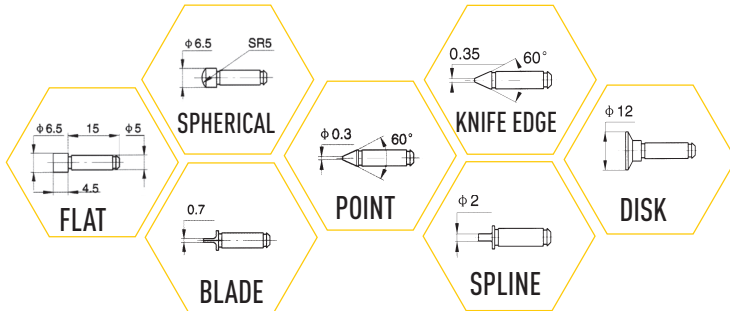

Item No	ANVILS SET
110750100	7 PAIRS: FLAT, SPHERICAL, DISK, BLADE, POINT, SPLINE, KNIFE EDGE

## BALL ANVILS



Item No	Ball dia	Module	Pitch
	mm		
110740001	1	0,6-0,65	45
110740002	1,5	0,9-1,0	28-26
110740003	2	1,25	22
110740004	2,5	1,5	17
110740005	3	1,75	15
110740006	3,5	2	13
110740007	4	2,25	11
110740008	4,5	2,5	10
110740009	5	2,75	9
110740010	6	3,5	7
110740100	Ball anvils SET 10 pcs 1-6mm		

## THREAD STANDARDS



## DISK ANVILS

Item No	Disk D
	mm
110750020	20
110750025	25
110750030	30
110750035	35

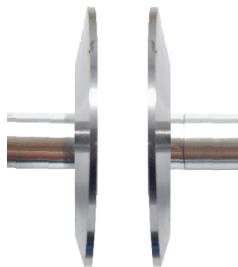

Item No	STANDARDS
110710005	50 mm METRIC 60
110710010	100 mm METRIC 60
110710015	150 mm METRIC 60
110710020	200 mm METRIC 60
110710025	250 mm METRIC 60
110710030	300 mm METRIC 60
110710035	350 mm METRIC 60
110710040	400 mm METRIC 60
110710045	450 mm METRIC 60
110720005	50 mm WHITWORTH 55
110720010	100 mm WHITWORTH 55
110720015	150 mm WHITWORTH 55
110720020	200 mm WHITWORTH 55
110720025	250 mm WHITWORTH 55
110720030	300 mm WHITWORTH 55
110720035	350 mm WHITWORTH 55
110720040	400 mm WHITWORTH 55
110720045	450 mm WHITWORTH 55

## THREAD ANVILS SET



Item No	ANVILS SET
110710001	METRIC 60 0.4-7mm 6pcs
110720001	WHITWORTH 55 60-3.5 TPI 10pcs

## OPTIONAL ACCESSORIES

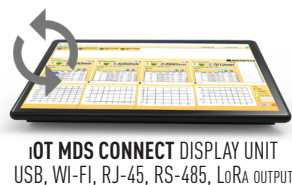

- Industry 4.0 adopted sub-micron Thread micrometer with computerized MICS system with 2.4" color Touchscreen
- Functions: On-line Graphic, Analog scale, Go/NoGo, Max/Min, Formula, Timer, Linear correction, Temperature correction
- Measuring HUB: Wireless MICROTECH instrument connection, Synchronization, 2D mode, 2D Graph, Probe mode, Compensation
- Memory manager: 2000 values, Folders system, Statistics mode, Memory data transfer
- Interchangeable anvils SET includes (Metric 60 or Whitworth 55). Custom anvils for request.
- **4 MODES DATA TRANSFER:** WIRELESS to MDS app (Windows, Android, iOS, MacOS); WIRELESS HID, WIRELESS HID+MAC, USB HID
- Calibration certificate included (ISO17025 (Ilac MRA))



**NON-ROTATING**



0,1µm

**THREAD ANVILS SET INCLUDES**

Item No	Range		Resol.	Accur.	Anvils SET	Thread standard	NON-ROTATING	Analog scale	Graphic	Preset	Go/NoGo	Max/Min	Formula	Timer	Temp comp	Linear corr	Calibr date	Recharge	2D Synchronize	Memory	WIRELESS	USB		
	mm	inch																					mm	µm
110710258	0-25	0-1"	0,0001	±3	0.4-7mm 6pcs	•	•	•	•	•	•	•	•	•	•	•	•	•	•	•	•	•		
110710508	25-50	1-2"		±3		•	•	•	•	•	•	•	•	•	•	•	•	•	•	•	•	•	•	•
110710758	50-75	2-3"		±4		•	•	•	•	•	•	•	•	•	•	•	•	•	•	•	•	•	•	•
110711008	75-100	3-4"		±4		•	•	•	•	•	•	•	•	•	•	•	•	•	•	•	•	•	•	•
110711258	100-125	4-5"		±5		•	•	•	•	•	•	•	•	•	•	•	•	•	•	•	•	•	•	•
110711508	125-150	5-6"		±5		•	•	•	•	•	•	•	•	•	•	•	•	•	•	•	•	•	•	•
110711758	150-175	6-7"		±6		•	•	•	•	•	•	•	•	•	•	•	•	•	•	•	•	•	•	•
110712008	175-200	7-8"		±7		•	•	•	•	•	•	•	•	•	•	•	•	•	•	•	•	•	•	•
110712258	200-225	8-9"		±7		•	•	•	•	•	•	•	•	•	•	•	•	•	•	•	•	•	•	•
110712508	225-250	9-10"		±8		•	•	•	•	•	•	•	•	•	•	•	•	•	•	•	•	•	•	•
110712758	250-275	10-11"		±8		•	•	•	•	•	•	•	•	•	•	•	•	•	•	•	•	•	•	•
110713008	275-300	11-12"		±8		•	•	•	•	•	•	•	•	•	•	•	•	•	•	•	•	•	•	•
110713258	325-350	12-13"		±9		•	•	•	•	•	•	•	•	•	•	•	•	•	•	•	•	•	•	•
110713508	350-375	13-14"		±9		•	•	•	•	•	•	•	•	•	•	•	•	•	•	•	•	•	•	•
110713758	250-375	14-15"		±10		•	•	•	•	•	•	•	•	•	•	•	•	•	•	•	•	•	•	•
110714008	375-400	15-16"		±10		•	•	•	•	•	•	•	•	•	•	•	•	•	•	•	•	•	•	•

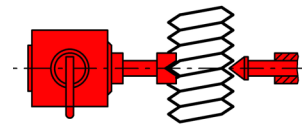

OPTIONAL SETTING ROD



**OPTIONAL ACCESSORIES**

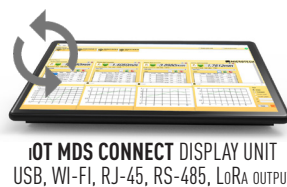

DOWNLOAD APP



- Industry 4.0 adopted sub-micron Thread micrometer with computerized MICS system with 2.4" color Touchscreen
- Functions: On-line Graphic, Analog scale, Go/NoGo, Max/Min, Formula, Timer, Linear correction, Temperature correction
- Measuring HUB: Wireless MICROTECH instrument connection, Synchronization, 2D mode, 2D Graph, Probe mode, Compensation
- Memory manager: 2000 values, Folders system, Statistics mode, Memory data transfer
- Interchangeable anvils SET includes (Metric 60 or Whitworth 55). Custom anvils for request.
- **4 MODES DATA TRANSFER:** WIRELESS to MDS app (Windows, Android, iOS, MacOS); WIRELESS HID, WIRELESS HID+MAC, USB HID
- Calibration certificate included (ISO17025 (Ilac MRA))



## THREAD ANVILS SET INCLUDES

Item No	Range		Resol.	Accur.	Anvils SET	Thread standard	NON-ROTATING	Analog scale	Graphic	Preset	Go/NoGo	Max/Min	Formula	Timer	Temp comp	Linear corr	Calibr date	Recharge	2D Synchronize	Memory	WIRELESS	USB			
	mm	inch																					mm	µm	
110720258	0-25	0-1"	0,0001	±3	60-3.5 TPI 10pcs	•	•	•	•	•	•	•	•	•	•	•	•	•	•	•	•	•	•		
110720508	25-50	1-2"		±3		•	•	•	•	•	•	•	•	•	•	•	•	•	•	•	•	•	•	•	•
110720758	50-75	2-3"		±4		•	•	•	•	•	•	•	•	•	•	•	•	•	•	•	•	•	•	•	•
110721008	75-100	3-4"		±4		•	•	•	•	•	•	•	•	•	•	•	•	•	•	•	•	•	•	•	•
110721258	100-125	4-5"		±5		•	•	•	•	•	•	•	•	•	•	•	•	•	•	•	•	•	•	•	•
110721508	125-150	5-6"		±5		•	•	•	•	•	•	•	•	•	•	•	•	•	•	•	•	•	•	•	•
110721758	150-175	6-7"		±6		•	•	•	•	•	•	•	•	•	•	•	•	•	•	•	•	•	•	•	•
110722008	175-200	7-8"		±7		•	•	•	•	•	•	•	•	•	•	•	•	•	•	•	•	•	•	•	•
110722258	200-225	8-9"		±7		•	•	•	•	•	•	•	•	•	•	•	•	•	•	•	•	•	•	•	•
110722508	225-250	9-10"		±8		•	•	•	•	•	•	•	•	•	•	•	•	•	•	•	•	•	•	•	•
110722758	250-275	10-11"		±8		•	•	•	•	•	•	•	•	•	•	•	•	•	•	•	•	•	•	•	•
110723008	275-300	11-12"		±8		•	•	•	•	•	•	•	•	•	•	•	•	•	•	•	•	•	•	•	•
110723258	325-350	12-13"		±9		•	•	•	•	•	•	•	•	•	•	•	•	•	•	•	•	•	•	•	•
110723508	350-375	13-14"		±9		•	•	•	•	•	•	•	•	•	•	•	•	•	•	•	•	•	•	•	•
110723758	250-375	14-15"		±10		•	•	•	•	•	•	•	•	•	•	•	•	•	•	•	•	•	•	•	•
110724008	375-400	15-16"		±10		•	•	•	•	•	•	•	•	•	•	•	•	•	•	•	•	•	•	•	•

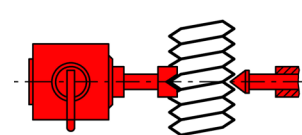

OPTIONAL SETTING ROD



### OPTIONAL ACCESSORIES

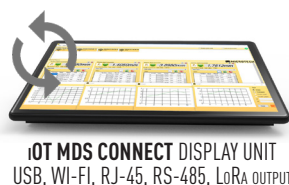

### DOWNLOAD APP



## MICROTECH

- Digital DISK micrometers
- NON-rotating spindle with Disk anvils D 20
- Calibration certificate included (ISO17025 (Ilac MRA))

### NON-ROTATING



Item No	Range		Reso- lution	Accu- racy	Disk	NON-ROTATING
	mm	inch	mm	µm	mm	
110780251	0-25	0-1"	0,001	±4	D 20	•
110780501	25-50	1-2"		±4		•
110780751	50-75	2-3"		±5		•
110781001	75-100	3-4"		±5		•

## DISK COMPUTERIZED MICROMETER

- Industry 4.0 adopted sub-micron DISK micrometer with computerized MICS system for measuring Gear tooth width
- NON-rotating spindle with Disk anvils D 20
- Functions: On-line Graphic, Analog scale, Go/NoGo, Max/Min, Formula, Timer, Linear correction, Temperature correction
- **4 MODES DATA TRANSFER:** WIRELESS to MDS app (Windows, Android, iOS, MacOS); WIRELESS HID, WIRELESS HID+MAC, USB HID
- Calibration certificate included (ISO17025 (Ilac MRA))



### NON-ROTATING

0,1µm

20MM

MEASURING HUB  
MICROTECH DEVICES CONNECT



WIRELESS TO MDS APP  
WIRELESS HID+MAC  
USB HID



Item No	Range		Reso- lution	Accu- racy	Disk	NON-ROTATING	Analog scale	Graphic	Preset	Go/NoGo	Max/Min	Formula	Timer	Temp comp	Linear corr	Calibr date	Recharge	Memory	WIRELESS	USB		
	mm	inch	mm	µm	mm																	
110780258	0-25	0-1"	0,0001	±3	D 20	•	•	•	•	•	•	•	•	•	•	•	•	•	Folders / 2000	Long range	USB HID /	
110780508	25-50	1-2"		±3		•	•	•	•	•	•	•	•	•	•	•	•	•				•
110780758	50-75	2-3"		±4		•	•	•	•	•	•	•	•	•	•	•	•	•				•
110781008	75-100	3-4"		±4		•	•	•	•	•	•	•	•	•	•	•	•	•				•

DOWNLOAD APP



MADE IN UKRAINE



- Industry 4.0 adopted sub-micron DISK micrometer with computerized MICS system for measuring Gear tooth width
- **NON-rotating spindle** with Disk anvils D 35mm (custom Disk anvils up to 60mm for request)
- Functions: On-line Graphic, Analog scale, Go/NoGo, Max/Min, Formula, Timer, Linear correction, Temperature correction
- **4 MODES DATA TRANSFER:** WIRELESS to MDS app (Windows, Android, iOS, MacOS); WIRELESS HID, WIRELESS HID+MAC, USB HID
- Calibration certificate included (ISO17025 (Ilac MRA))

MEASURING HUB  
MICROTECH DEVICES CONNECT



WIRELESS TO MDS APP  
WIRELESS HID+MAC  
USB HID



**NON-ROTATING**



D 35MM



Item No	Range		Reso- lution	Accu- racy	Disk	NON-ROTATING	Analog scale	Graphic	Preset	Go/NoGo	Max/Min	Formula	Timer	Temp comp	Linear corr	Calibr date	Recharge	Memory	WIRELESS	USB			
	mm	inch	mm	µm	mm																		
110780257	0-25	0-1"	0,0001	±4	D 35	•	•	•	•	•	•	•	•	•	•	•	•						
110780507	25-50	1-2"		±4		•	•	•	•	•	•	•	•	•	•	•	•	•	•				
110780757	50-75	2-3"		±5		•	•	•	•	•	•	•	•	•	•	•	•	•	•				
110781007	75-100	3-4"		±5		•	•	•	•	•	•	•	•	•	•	•	•	•	•				
110781257	100-125	4-5"		±7		•	•	•	•	•	•	•	•	•	•	•	•	•	•				
110781507	125-150	5-6"		±7		•	•	•	•	•	•	•	•	•	•	•	•	•	•				
110781757	150-175	6-7"		±8		•	•	•	•	•	•	•	•	•	•	•	•	•	•				
110782007	175-200	7-8"		±8		•	•	•	•	•	•	•	•	•	•	•	•	•	•				
110782257	200-225	8-9"		±8		•	•	•	•	•	•	•	•	•	•	•	•	•	•				
110782507	225-250	9-10"		±8		•	•	•	•	•	•	•	•	•	•	•	•	•	•				
110782757	250-275	10-11"		±8		•	•	•	•	•	•	•	•	•	•	•	•	•	•				
110783007	275-300	11-12"		±8		•	•	•	•	•	•	•	•	•	•	•	•	•	•				
110783257	300-325	12-13"		±9		•	•	•	•	•	•	•	•	•	•	•	•	•	•				
110783507	325-350	13-14"		±9		•	•	•	•	•	•	•	•	•	•	•	•	•	•				
110783757	350-375	14-15"		±9		•	•	•	•	•	•	•	•	•	•	•	•	•	•				
110784007	375-400	15-16"		±9		•	•	•	•	•	•	•	•	•	•	•	•	•	•				
110784257	400-425	16-17"	±10	•	•	•	•	•	•	•	•	•	•	•	•	•	•						
110784507	425-450	17-18"	±10	•	•	•	•	•	•	•	•	•	•	•	•	•	•						
110784757	450-475	18-19"	±10	•	•	•	•	•	•	•	•	•	•	•	•	•	•						
110785007	475-500	19-20"	±10	•	•	•	•	•	•	•	•	•	•	•	•	•	•						

### OPTIONAL ACCESSORIES

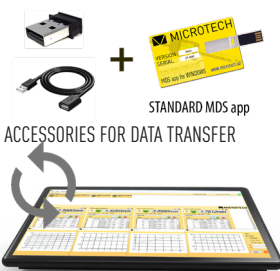

IoT MDS CONNECT DISPLAY UNIT  
USB, WI-FI, RJ-45, RS-485, LoRa OUTPUT

DOWNLOAD APP



- **Industry 4.0** adopted sub-micron BALL anvils micrometer for measuring over pin diameter of Gear
- **Functions:** On-line Graphic, Analog scale, Go/NoGo, Max/Min, Formula, Timer, Linear correction, Temperature correction
- **Measuring HUB:** Wireless MICROTECH instrument connection, Synchronization, 2D mode, 2D Graph, Probe mode, Compensation
- **Memory manager:** 2000 values, Folders system, Statistics mode, Memory data transfer
- Interchangeable anvils SET includes (Ball D 1-6mm / Module 0,6-3,5/ Pitch 7-45 10pcs). Custom anvils for request.
- **4 MODES DATA TRANSFER:** WIRELESS to MDS app (Windows, Android, iOS, MacOS); WIRELESS HID, WIRELESS HID+MAC, USB HID
- **Calibration** certificate included (ISO17025 (Ilac MRA))



Item No	Range		Resol.	Accur.	Anvils SET	NON-ROTATING	Analog scale	Graphic	Preset	Go/NoGo	Max/Min	Formula	Timer	Temp comp	Linear corr	Calibr date	Recharge	2D Synchronize	Memory	WIRELESS	USB		
	mm	inch																				mm	μm
110740258	0-25	0-1"	0,0001	±3	OPTIONAL	•	•	•	•	•	•	•	•	•	•	•	•	•	•	•	•		
110740508	25-50	1-2"		±3		•	•	•	•	•	•	•	•	•	•	•	•	•	•	•	•	•	•
110740758	50-75	2-3"		±4		•	•	•	•	•	•	•	•	•	•	•	•	•	•	•	•	•	•
110741008	75-100	3-4"		±4		•	•	•	•	•	•	•	•	•	•	•	•	•	•	•	•	•	•
110741258	100-125	4-5"		±5		•	•	•	•	•	•	•	•	•	•	•	•	•	•	•	•	•	•
110741508	125-150	5-6"		±5		•	•	•	•	•	•	•	•	•	•	•	•	•	•	•	•	•	•
110741758	150-175	6-7"		±6		•	•	•	•	•	•	•	•	•	•	•	•	•	•	•	•	•	•
110742008	175-200	7-8"		±7		•	•	•	•	•	•	•	•	•	•	•	•	•	•	•	•	•	•
110742258	200-225	8-9"		±7		•	•	•	•	•	•	•	•	•	•	•	•	•	•	•	•	•	•
110742508	225-250	9-10"		±8		•	•	•	•	•	•	•	•	•	•	•	•	•	•	•	•	•	•
110742758	250-275	10-11"		±8		•	•	•	•	•	•	•	•	•	•	•	•	•	•	•	•	•	•
110743008	275-300	11-12"		±8		•	•	•	•	•	•	•	•	•	•	•	•	•	•	•	•	•	•
110743258	325-350	12-13"		±9		•	•	•	•	•	•	•	•	•	•	•	•	•	•	•	•	•	•
110743508	350-375	13-14"		±9		•	•	•	•	•	•	•	•	•	•	•	•	•	•	•	•	•	•
110743758	250-375	14-15"		±10		•	•	•	•	•	•	•	•	•	•	•	•	•	•	•	•	•	•
110744008	375-400	15-16"		±10		•	•	•	•	•	•	•	•	•	•	•	•	•	•	•	•	•	•

DOWNLOAD APP



**BALL ANVILS**

Item No	Ball dia	Module	Pitch
	mm		
110740001	1	0,6-0,65	45
110740002	1,5	0,9-1,0	28-26
110740003	2	1,25	22
110740004	2,5	1,5	17
110740005	3	1,75	15
110740006	3,5	2	13
110740007	4	2,25	11
110740008	4,5	2,5	10
110740009	5	2,75	9
110740010	6	3,5	7
110740100	Ball anvils SET 10 pcs 1-6mm		



OPTIONAL ACCESSORIES



**iOT MDS CONNECT** DISPLAY UNIT  
USB, WI-FI, RJ-45, RS-485, LoRA OUTPUT

# TUBE DIGITAL MICROMETER

- Digital TUBE micrometers
- Calibration certificate included (ISO17025 (Ilac MRA))

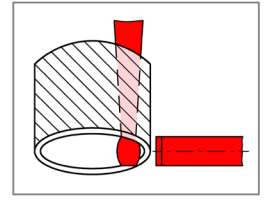

Item No	Range		Reso- lution	Accu- racy	Anvils types	Proof
	mm	inch				
110350251	0-25	0-1"	0,001	±3	Tube D 4.7	IP-65
110350501	25-50	1-2"		±3		
110350751	50-75	2-3"		±3		
110351001	75-100	3-4"		±3		

# TUBE COMPUTERIZED MICROMETER

- Computerized TUBE micrometers with 0.1 micron resolution
- Computerized MICS indication system Modification with Long range Wireless, Wireless HID or USB HID data transfer to Windows, Android, iOS, macOS, Linux systems direct to any app.
- Calibration certificate included (ISO17025 (Ilac MRA))

MEASURING HUB  
MICROTECH DEVICES CONNECT



WIRELESS TO MDS APP  
WIRELESS HID+MAC  
USB HID

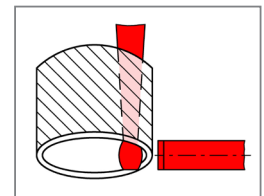
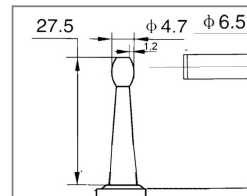

Item No	Range		Reso- lution	Accu- racy	Anvils types	Proof	Preset	Analog scale	Graphic	Go/NoGo	Max/Min	Formula	Timer	Temp comp	Linear corr	Calibr date	Recharge	Memory	WIRELESS	USB
	mm	inch																		
110350258	0-25	0-1"	0,0001	±2	Tube D 4.7	IP-65	•	•	•	•	•	•	•	•	•	•	•	2000 val	Long+ HID	USB HID
110350508	25-50	1-2"		±2																
110350758	50-75	2-3"		±2.5																
110351008	75-100	3-4"		±2.5																

## OPTIONAL ACCESSORIES

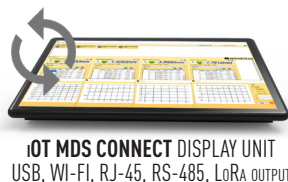
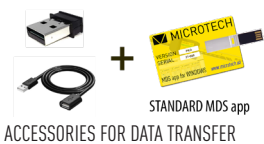

DOWNLOAD APP



- Digital DOUBLE SPHERICAL micrometers
- Calibration certificate included (ISO17025 (Ilac MRA))

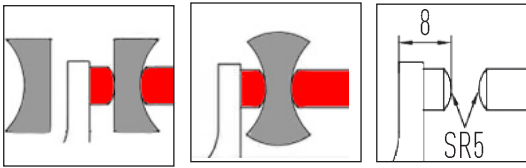

Item No	Range		Resolution	Accuracy	Anvils types	Proof
	mm	inch	mm	µm		
110360251	0-25	0-1"	0,001	±3	Sphere R 5mm	IP-65
110360501	25-50	1-2"		±3		
110360751	50-75	2-3"		±3		
110361001	75-100	3-4"		±3		

**DOUBLE SPHERICAL** COMPUTERIZED MICROMETER

- Computerized DOUBLE SPHERICAL micrometers with 0.1 micron resolution
- Computerized MICS indication system Modification with Long range Wireless, Wireless HID or USB HID data transfer to Windows, Android, iOS, macOS, Linux systems direct to any app.
- Calibration certificate included (ISO17025 (Ilac MRA))

MEASURING HUB  
MICROTECH DEVICES CONNECT



WIRELESS TO MDS APP  
WIRELESS HID+MAC  
USB HID

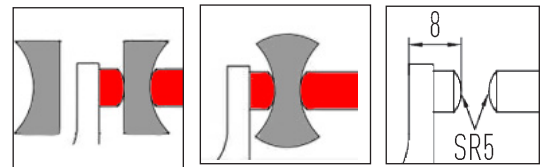

Item No	Range		Reso- lution	Accu- racy	Anvils types	Proof	Preset	Analog scale	Graphic	Go/NoGo	Max/Min	Formula	Timer	Temp comp	Linear corr	Calibr date	Recharge	Memory	WIRELESS	USB
	mm	inch	mm	µm																
110360258	0-25	0-1"	0,0001	±2	Sphere R 5mm	IP-65	•	•	•	•	•	•	•	•	•	•	•	2000 val	Long+ HID	USB HID
110360508	25-50	1-2"		±2																
110360758	50-75	2-3"		±2.5																
110361008	75-100	3-4"		±2.5																

DOWNLOAD APP



OPTIONAL ACCESSORIES

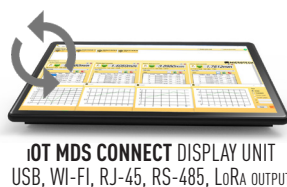

# BLADE DIGITAL MICROMETER

- Digital BLADE micrometers
- NON-rotating spindle with Disk anvils D 20
- Calibration certificate included (ISO17025 (Iac MRA))

## NON-ROTATING



Item No	Range		Reso- lution	Accu- racy	Anvils types	Proof
	mm	inch	mm	µm		
110660251	0-25	0-1"	0,001	±4	6,5x0,75mm	IP-65
110660501	25-50	1-2"		±4		
110660751	50-75	2-3"		±5		
110661001	75-100	3-4"		±5		

# BLADE COMPUTERIZED MICROMETER

- Computerized BLADE micrometers with 0.1 micron resolution
- Computerized MICS indication system Modification with Long range Wireless, Wireless HID or USB HID data transfer to Windows, Android, iOS, macOS, Linux systems direct to any app.
- Calibration certificate included (ISO17025 (Iac MRA))

MEASURING HUB  
MICROTECH DEVICES CONNECT



WIRELESS TO MDS APP  
WIRELESS HID+MAC  
USB HID



## NON-ROTATING

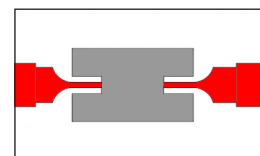
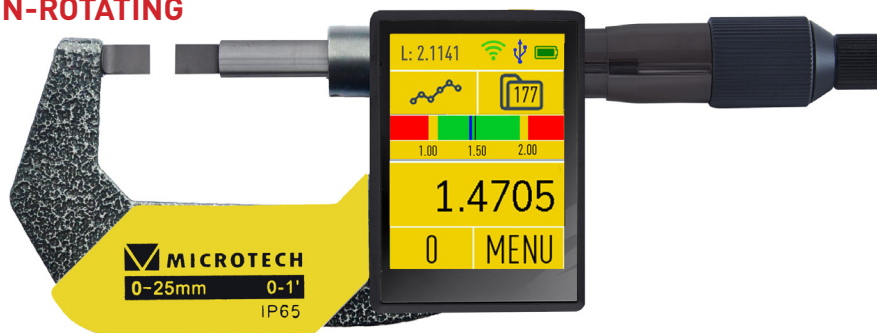

Item No	Range		Reso- lution	Accu- racy	Anvils types	Proof	Preset	Analog scale	Graphic	Go/NoGo	Max/Min	Formula	Timer	Temp comp	Linear corr	Calibr date	Recharge	Memory	WIRELESS	USB			
	mm	inch	mm	µm																			
110660258	0-25	0-1"	0,0001	±3	6,5x 0,75mm	IP-65	•	•	•	•	•	•	•	•	•	•	•	•	2000 val	Long + HID	USB HID		
110660508	25-50	1-2"		±3			•	•	•	•	•	•	•	•	•	•	•	•				•	•
110660758	50-75	2-3"		±4			•	•	•	•	•	•	•	•	•	•	•	•				•	•
110661008	75-100	3-4"		±4			•	•	•	•	•	•	•	•	•	•	•	•				•	•

## OPTIONAL ACCESSORIES

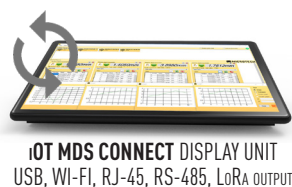

## DOWNLOAD APP



- Digital CABLE CRIMPING micrometers
- Calibration certificate included (ISO17025 (Iac MRA))

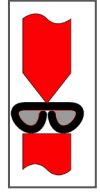

Item No	Range		Resolution	Accuracy	Anvils types	Proof
	mm	inch	mm	µm		
110550251	0-20	0-0.8"	0,001	±4	Point & Blade 0.75x6.5	IP-65

**CABLE CRIMPING** COMPUTERIZED MICROMETER

- Computerized CABLE CRIMPING micrometers with 0.1 micron resolution
- Computerized MICS indication system Modification with Long range Wireless, Wireless HID or USB HID data transfer to Windows, Android, iOS, macOS, Linux systems direct to any app.
- Calibration certificate included (ISO17025 (Iac MRA))

MEASURING HUB  
MICROTECH DEVICES CONNECT



WIRELESS TO MDS APP  
WIRELESS HID+MAC  
USB HID

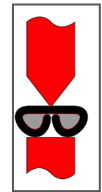

Item No	Range		Resolution	Accuracy	Anvils types	Proof	Preset	Analog scale	Graphic	Go/NoGo	Max/Min	Formula	Timer	Temp comp	Linear corr	Calibr date	Recharge	Memory	WIRELESS	USB
	mm	inch	mm	µm																
110550258	0-20	0-0.8"	0,0001	±3	Point & Blade 0.75x6.5	IP-65	•	•	•	•	•	•	•	•	•	•	•	•	•	•

OPTIONAL ACCESSORIES

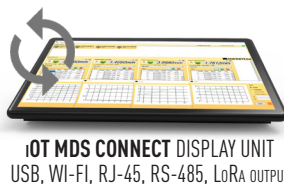

DOWNLOAD APP



# SMALL TIP DIGITAL MICROMETER

- Digital SMALL TIP micrometers
- Calibration certificate included (ISO17025 (Ilac MRA))

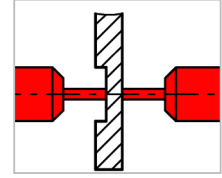
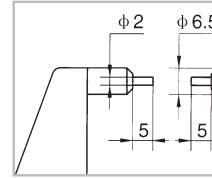

Item No	Range		Reso- lution	Accu- racy	Anvils types	Proof
	mm	inch	mm	μm		
110650251	0-25	0-1"	0,001	±4	D 2mm	IP-65
110650501	25-50	1-2"		±4		
110650751	50-75	2-3"		±5		
110651001	75-100	3-4"		±5		

# SMALL TIP COMPUTERIZED MICROMETER

- Computerized SMALL TIP micrometers with 0.1 micron resolution
- Computerized MICS indication system Modification with Long range Wireless, Wireless HID or USB HID data transfer to Windows, Android, iOS, macOS, Linux systems direct to any app.
- Calibration certificate included (ISO17025 (Ilac MRA))

MEASURING HUB  
MICROTECH DEVICES CONNECT



WIRELESS TO MDS APP  
WIRELESS HID+MAC  
USB HID

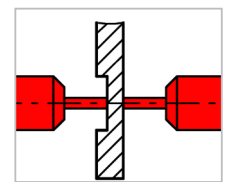
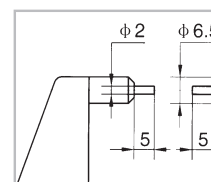
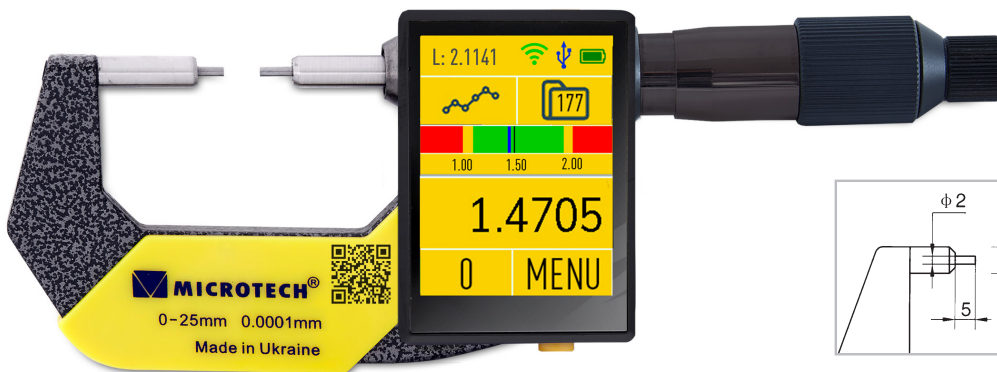

Item No	Range		Reso- lution	Accu- racy	Anvils types	Proof	Preset	Graphic	Analog scale	Go/NoGo	Max/Min	Formula	Timer	Temp comp	Linear corr	Calibr date	Recharge	Memory	WIRELESS	USB	
	mm	inch	mm	μm																	
110650258	0-25	0-1"	0,0001	±3	D 2mm	IP-65	•	•	•	•	•	•	•	•	•	•	•	2000 val	Long+ HID	USB HID	
110650508	25-50	1-2"		±3			•	•	•	•	•	•	•	•	•	•	•				•
110650758	50-75	2-3"		±4			•	•	•	•	•	•	•	•	•	•	•				•
110651008	75-100	3-4"		±4			•	•	•	•	•	•	•	•	•	•	•				•

## OPTIONAL ACCESSORIES

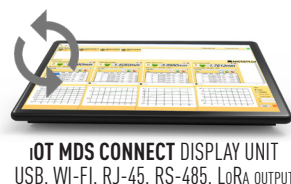

DOWNLOAD APP



- Digital POINT micrometers
- Calibration certificate included (ISO17025 (Ilac MRA))



Item No	Range		Reso- lution	Accu- racy	Anvils types	Proof
	mm	inch	mm	μm		
110450251	0-25	0-1"	0,001	±4	Pointed	IP-65
110450501	25-50	1-2"		±4		
110450751	50-75	2-3"		±5		
110451001	75-100	3-4"		±5		

**POINT** COMPUTERIZED MICROMETER

- Computerized POINT micrometers with 0.1 micron resolution
- Computerized MICS indication system Modification with Long range Wireless, Wireless HID or USB HID data transfer to Windows, Android, iOS, macOS, Linux systems direct to any app.
- Calibration certificate included (ISO17025 (Ilac MRA))

MEASURING HUB  
MICROTECH DEVICES CONNECT



WIRELESS TO MDS APP  
WIRELESS HID+MAC  
USB HID

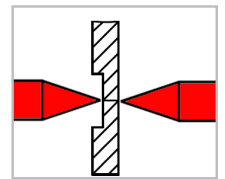
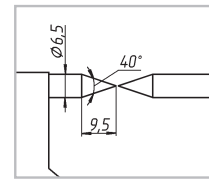
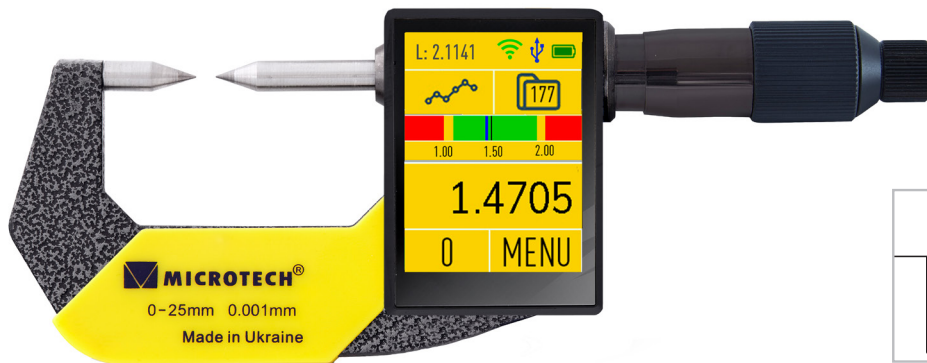

Item No	Range		Reso- lution	Accu- racy	Anvils types	Proof	Preset	Graphic	Analog scale	Go/NoGo	Max/Min	Formula	Timer	Temp comp	Linear corr	Calibr date	Recharge	Memory	WIRELESS	USB
	mm	inch	mm	μm																
110450258	0-25	0-1"	0,0001	±3	Pointed	IP-65	•	•	•	•	•	•	•	•	•	•	•	2000 val	Long+ HID	USB HID
110450508	25-50	1-2"		±3																
110450758	50-75	2-3"		±4																
110451008	75-100	3-4"		±4																

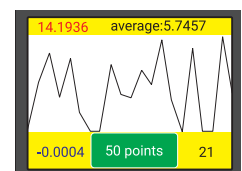

**ON-LINE**  
GRAPHIC MODE

DOWNLOAD APP



**OPTIONAL ACCESSORIES**



**iOT MDS CONNECT DISPLAY UNIT**  
USB, WI-FI, RJ-45, RS-485, LoRa OUTPUT



**iOT DATA BUTTON**



# INSIDE DIGITAL MICROMETER

- Digital IP65 inside micrometer
- Calibration certificate included (ISO17025 (Ilac MRA))



Item No	Range		Resolution	Accuracy	Anvils types	Setting ring	Proof
	mm	inch	mm	μm			
133800301	5-30	0.2-1.2"	0,001	±5	D 2mm	•	IP-65
133800501	25-50	1-2"		±5			
133800751	50-75	2-3"		±6	R12mm		
133801001	75-100	3-4"		±6			

# INSIDE COMPUTERIZED MICROMETER

- Computerized **MICS** indication system Modification with Long range Wireless, Wireless HID or USB HID data transfer to Windows, Android, iOS, macOS, Linux systems direct to any app.
- Calibration certificate included (ISO17025 (Ilac MRA))

MEASURING HUB  
MICROTECH DEVICES CONNECT

WIRELESS TO MDS APP  
WIRELESS HID+MAC  
USB HID

ON-LINE GRAPHIC MODE

Item No	Range		Resolution	Accuracy	Anvils types	Setting ring	Proof	Preset	Go/NoGo	Max/Min	Formula	Timer	Temp comp	Linear corr	Calibr date	Recharge	Memory	WIRELESS	USB
	mm	inch	mm	μm															
133800308	5-30	0.2-1.2"	0,0001	±4	D 2mm	IP-65	•	•	•	•	•	•	•	•	•	•	2000 val	Long+ HID	USB HID
133800508	25-50	1-2"		±4			R12mm	•	•	•	•	•	•	•	•	•			
133800758	50-75	2-3"		±4	option			•	•	•	•	•	•	•	•	•			
133801008	75-100	3-4"		±4	•		•	•	•	•	•	•	•	•	•				

## OPTIONAL ACCESSORIES

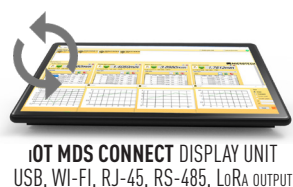

DOWNLOAD APP



- Digital IP65 depth micrometer
- Calibration certificate included (ISO17025 (Ilac MRA))



Item No	Range		Resolution	Accuracy	Base	Proof
	mm	inch				
110900155	0-150	0-6"	0,001	±5	100	IP-65
110900205	0-200	0-8"		±6		
110900305	0-300	0-12"		±8		

- Computerized **MICS** indication system Modification with Long range Wireless, Wireless HID or USB HID data transfer to Windows, Android, iOS, macOS, Linux systems direct to any app.
- **Calibration** certificate included (ISO17025 (ILac MRA))

MEASURING HUB  
MICROTECH DEVICES CONNECT



WIRELESS TO MDS APP  
WIRELESS HID+MAC  
USB HID



0,1 μm



Item No	Range		Reso- lution	Accu- racy	Base	Proof	Preset	Go/NoGo	Max/Min	Formula	Timer	Temp comp	Linear corr	Calibr date	Recharge	Memory	WIRELESS	USB
	mm	inch	mm	μm	mm													
110900158	0-150	0-6"		±4			•	•	•	•	•	•	•	•	•	2000 val	Long+ HID	USB HID
110900208	0-200	0-8"	<b>0,0001</b>	±5	100	IP-65	•	•	•	•	•	•	•	•	•	•	•	•
110900308	0-300	0-12"		±6			•	•	•	•	•	•	•	•	•	•	•	•

### OPTIONAL ACCESSORIES



IoT MDS CONNECT DISPLAY UNIT  
USB, WI-FI, RJ-45, RS-485, LoRA OUTPUT



IoT DATA BUTTON

### DOWNLOAD APP



- Digital IP65 electronics
- Rotating or **Non-rotating**
- **Calibration** certificate included (ISO17025 (Ilac MRA))



Item No	Range		Resol.	Accu- racy	NON-ROTATING
	mm	inch	mm	µm	
110180020	0-25	0-1"	0.001	±2	•
110170020					
110181050	0-50	0-2"		±4	

**COMPUTERIZED MICROMETER** HEAD

- Computerized **MICS** indication system Modification with **Long range** Wireless, Wireless HID or USB HID data transfer to Windows, Android, iOS, macOS, Linux systems direct to any app.
- Rotating or **Non-rotating**
- **Calibration** certificate included (ISO17025 (Ilac MRA))

MEASURING HUB  
MICROTECH DEVICES CONNECT

WIRELESS TO MDS APP  
WIRELESS HID+MAC  
USB HID

0,1µm

MEASURING HUB  
MICROTECH DEVICES CONNECT

Item No	Range		Resol.	Accu- racy	NON-ROTATING	Measuring HUB	Graphic	Analog scale	Preset	Go/NoGo	Max/Min	Formula	Timer	Temp comp	Linear corr	Calibr date	Recharge	Memory	WIRELESS	USB
	mm	inch	mm	µm																
110180029	0-25	0-1"	0,0001	±1.5	•	•	•	•	•	•	•	•	•	•	•	•	•	•	•	•
110181029				±2.5	•	•	•	•	•	•	•	•	•	•	•	•	•	•	•	•
110181059	0-50	0-2"																	Folders / 2000 val	Long+ HID USB HID / Update

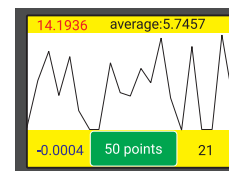

**ON-LINE GRAPHIC MODE**

**OPTIONAL ACCESSORIES**

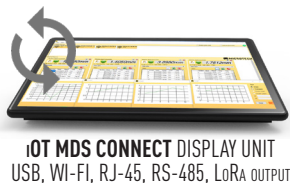

**DOWNLOAD APP**



- Industry 4.0 adopted sub-micron micrometer head with computerized MICS system with 2,4" color Touchscreen
- **WIDE RANGE (50mm) with NON-ROTATING SPINDLE**
- **Functions:** Go/NoGo, Max/Min, Formula, Timer, Linear correction, Temperature correction, Resolution selecting, Connection indication
- **Memory manager:** 2000 values, Folders system, Statistics mode, Memory data transfer
- **4 MODES DATA TRANSFER:** WIRELESS to MDS app (Windows, Android, iOS, MacOS); WIRELESS HID, WIRELESS HID+MAC, USB HID
- Top quality Aluminium housing and handle (CNC machined solid block)
- Calibration certificate included (ISO17025 (Iac MRA))

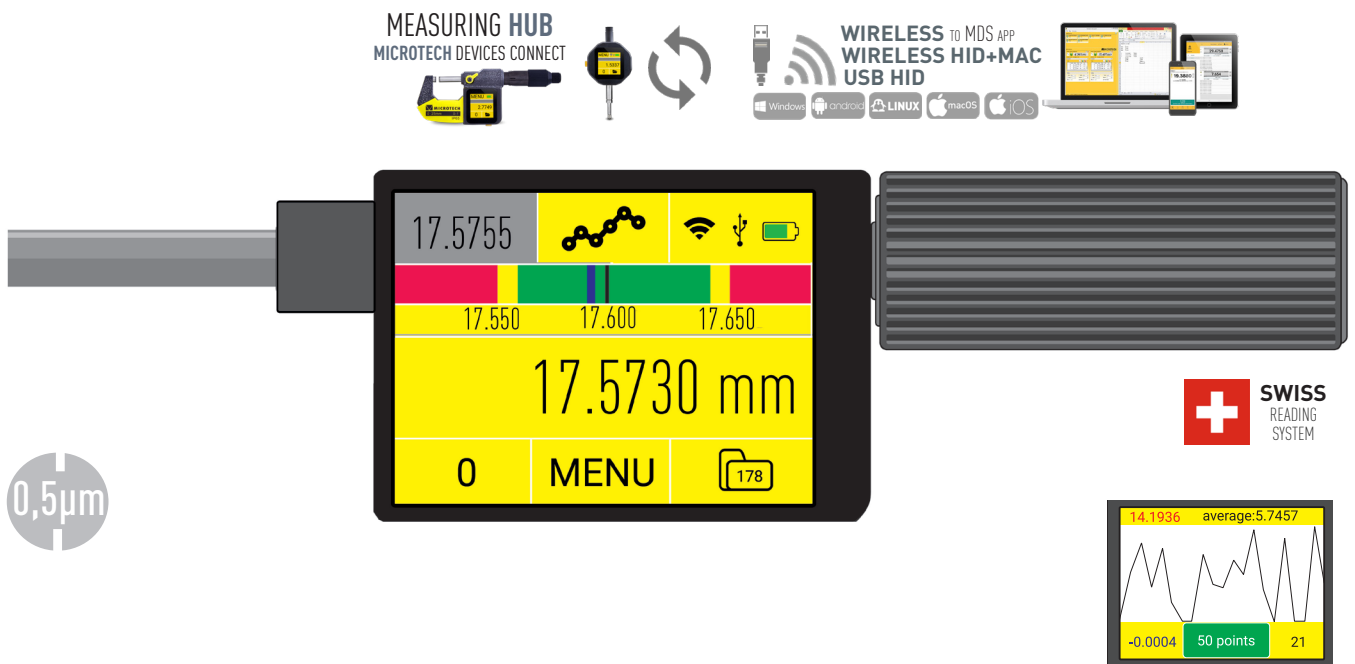

**RELEASE MARCH 2025**

**ON-LINE GRAPHIC MODE**

Item No	Range		Resol.	Accu-racy	Anvils	NON-ROTATING	Measuring HUB	Graphic	Analog scale	Preset	Go/NoGo	Max/Min	Formula	Timer	Temp comp	Linear corr	Calibr date	Recharge	Memory	WIRELESS	USB	
	mm	inch																				mm
110188059	0-50	0-2"	0,0005	±2	Flat carbide D8mm	•	•	•	•	•	•	•	•	•	•	•	•	•	•	•	•	•
110185059					Interchangeable anvils	•	•	•	•	•	•	•	•	•	•	•	•	•	•	•	•	•

### OPTIONAL ACCESSORIES

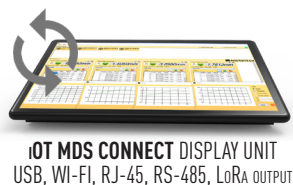

### DOWNLOAD APP



- Industry 4.0 adopted sub-micron Computerized Snap gauge
- Anvils D 8 mm
- Functions: On-line Graphic, Analog scale, Go/NoGo, Max/Min, Formula, Timer, Linear correction, Temperature correction
- Memory manager: 2000 values, Folders system, Statistics mode, Memory data transfer
- **4 MODES DATA TRANSFER:** WIRELESS to MDS app (Windows, Android, iOS, MacOS); WIRELESS HID, WIRELESS HID+MAC, USB HID
- Calibration certificate included (ISO17025 (Ilac MRA))

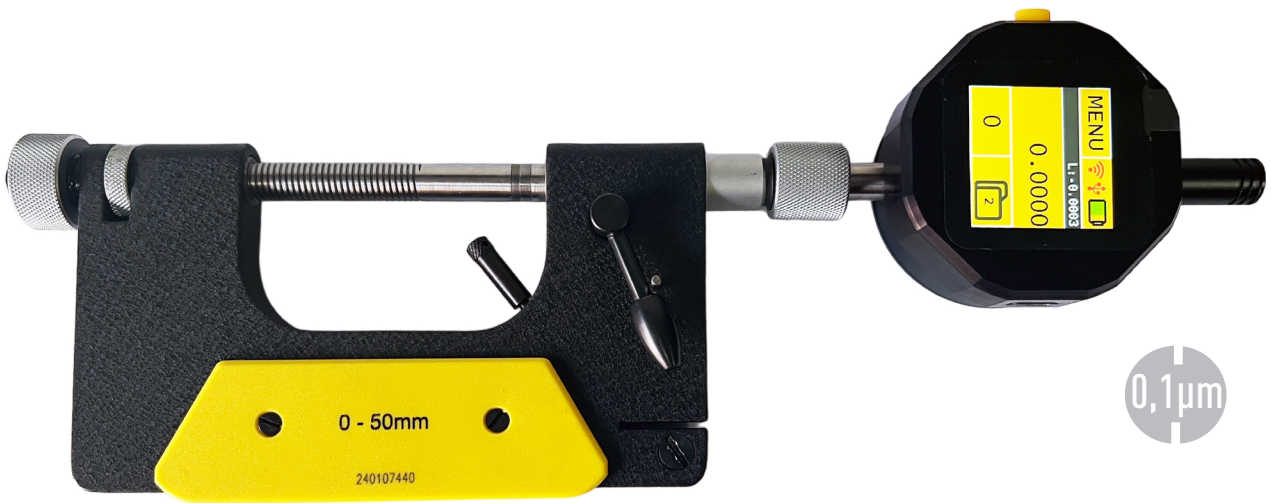

Item No	Range		Reso- lution	Accu- racy	Depth	Anvils type	Travel	Preset	Go/NoGo	Max/Min	Formula	Timer	Temp comp	Linear corr	Calibr date	Recharge	Memory	WIRELESS	USB	
	mm	inch																		mm
115050507	0-50	0-2"	0,0001	±3	32	D 8mm	3	•	•	•	•	•	•	•	•	•	Folders / 2000 val	Long range / HID	USB HID	
115051007	50-100	2-4"		±4	62			•	•	•	•	•	•	•	•	•				•
115051507	100-150	4-6"		±4	85			•	•	•	•	•	•	•	•	•				•
115052007	150-200	6-8"		±4	110			•	•	•	•	•	•	•	•	•				•
115052507	200-250	8-10"		±6	110			•	•	•	•	•	•	•	•	•				•
115053007	250-300	10-12"		±7	110			•	•	•	•	•	•	•	•	•				•
115053507	300-350	12-14"		±8	110			•	•	•	•	•	•	•	•	•				•
115054007	350-400	14-16"		±9	110			•	•	•	•	•	•	•	•	•				•
115054507	400-450	16-18"		±10	110			•	•	•	•	•	•	•	•	•				•
115055007	450-500	18-20"		±10	110			•	•	•	•	•	•	•	•	•				•

**OPTIONAL ACCESSORIES**

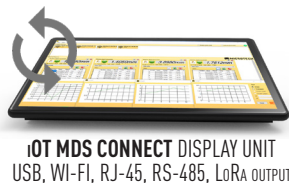

**DOWNLOAD APP**



# COMPUTERIZED DISK SNAP GAUGE

- Industry 4.0 adopted sub-micron Computerized Snap gauge
- Disk Anvils D 35 mm (other Diameter for request)
- Functions: On-line Graphic, Analog scale, Go/NoGo, Max/Min, Formula, Timer, Linear correction, Temperature correction
- Memory manager: 2000 values, Folders system, Statistics mode, Memory data transfer
- 4 MODES DATA TRANSFER: WIRELESS to MDS app (Windows, Android, iOS, MacOS); WIRELESS HID, WIRELESS HID+MAC, USB HID
- Calibration certificate included (ISO17025 (Ilac MRA))

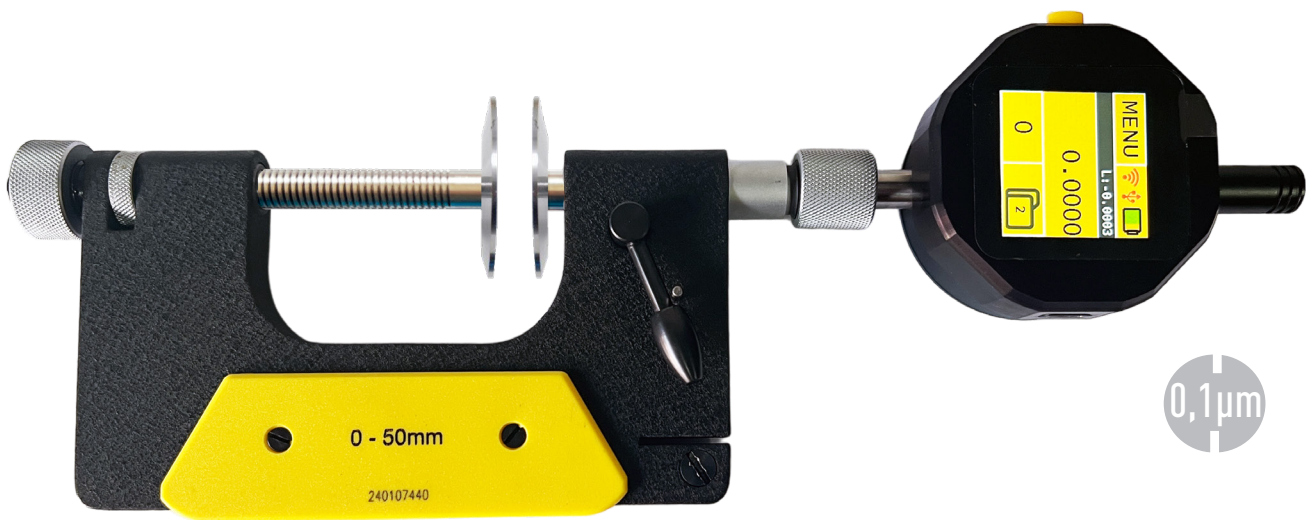

Item No	Range		Reso- lution	Accu- racy	Depth	Anvils type	Travel	Preset	Go/NoGo	Max/Min	Formula	Timer	Temp comp	Linear corr	Calibr date	Recharge	Memory	WIRELESS	USB			
	mm	inch																		mm	μm	mm
115050517	0-50	0-2"	0,0001	±4	32	D 35mm	3	•	•	•	•	•	•	•	•	•	•	•	•	•		
115051017	50-100	2-4"		±4	62			•	•	•	•	•	•	•	•	•	•	•	•	•	•	
115051517	100-150	4-6"		±6	85			•	•	•	•	•	•	•	•	•	•	•	•	•	•	•
115052017	150-200	6-8"		±7	110			•	•	•	•	•	•	•	•	•	•	•	•	•	•	•



## OPTIONAL ACCESSORIES

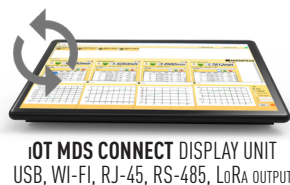

## DOWNLOAD APP



- Industry 4.0 adopted sub-micron Universal Computerized Snap gauge
- Interchangeable optional anvils
- Functions: On-line Graphic, Analog scale, Go/NoGo, Max/Min, Formula, Timer, Linear correction, Temperature correction
- Memory manager: 2000 values, Folders system, Statistics mode, Memory data transfer
- 4 MODES DATA TRANSFER: WIRELESS to MDS app (Windows, Android, iOS, MacOS); WIRELESS HID, WIRELESS HID+MAC, USB HID
- Calibration certificate included (ISO17025 (Ilac MRA))



ANVILS ARE OPTIONAL



THREAD ANVILS

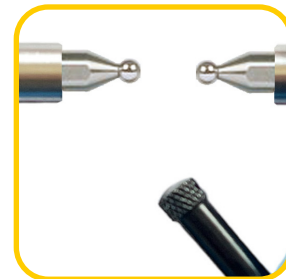

BALLS ANVILS

Item No	Range		Reso- lution	Accu- racy	Depth	Anvils	Travel	Preset	Go/NoGo	Max/Min	Formula	Timer	Temp comp	Linear corr	Calibr date	Recharge	Memory	WIRELESS	USB	
	mm	inch																		mm
115050477	0-40	0-2"	0,0001	±3	32	OPTIONAL	3	•	•	•	•	•	•	•	•	•	Folders / 2000 val	Long range / HID	USB HID	
115050977	40-90	2-4"		±4	62			•	•	•	•	•	•	•	•	•				•
115051477	90-140	4-6"		±4	85			•	•	•	•	•	•	•	•	•				•
115051977	140-190	6-8"		±4	110			•	•	•	•	•	•	•	•	•				•
115052377	170-230	8-10"		±6	110			•	•	•	•	•	•	•	•	•				•
115052577	200-250	8-10"		±6	110			•	•	•	•	•	•	•	•	•				•
115053077	250-300	10-12"		±7	110			•	•	•	•	•	•	•	•	•				•
115053577	300-350	12-14"		±8	110			•	•	•	•	•	•	•	•	•				•
115054077	350-400	14-16"		±9	110			•	•	•	•	•	•	•	•	•				•
115054577	400-450	16-18"		±10	110			•	•	•	•	•	•	•	•	•				•
115055077	450-500	18-20"	±10	110	•	•	•	•	•	•	•	•	•	•						

DOWNLOAD APP





UNIVERSAL ANVILS SET

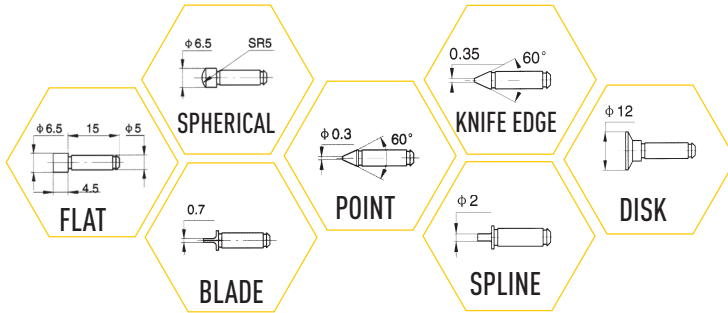

Item No	ANVILS SET
110750100	7 PAIRS: FLAT, SPHERICAL, DISK, BLADE, POINT, SPLINE, KNIFE EDGE

BALL ANVILS



Item No	Ball dia mm	Module	Pitch
110740001	1	0,6-0,65	45
110740002	1,5	0,9-1,0	28-26
110740003	2	1,25	22
110740004	2,5	1,5	17
110740005	3	1,75	15
110740006	3,5	2	13
110740007	4	2,25	11
110740008	4,5	2,5	10
110740009	5	2,75	9
110740010	6	3,5	7
110740100	Ball anvils SET 10 pcs 1-6mm		

THREAD STANDARDS



Item No	STANDARDS
110710005	50 mm METRIC 60
110710010	100 mm METRIC 60
110710015	150 mm METRIC 60
110710020	200 mm METRIC 60
110710025	250 mm METRIC 60
110710030	300 mm METRIC 60
110710035	350 mm METRIC 60
110710040	400 mm METRIC 60
110710045	450 mm METRIC 60
110720005	50 mm WHITWORTH 55
110720010	100 mm WHITWORTH 55
110720015	150 mm WHITWORTH 55
110720020	200 mm WHITWORTH 55
110720025	250 mm WHITWORTH 55
110720030	300 mm WHITWORTH 55
110720035	350 mm WHITWORTH 55
110720040	400 mm WHITWORTH 55
110720045	450 mm WHITWORTH 55

DISK ANVILS

Item No	Disk D mm
110750020	20
110750025	25
110750030	30
110750035	35

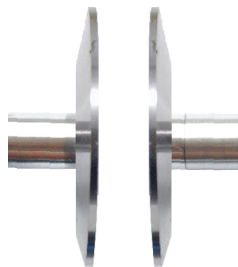

THREAD ANVILS SET



Item No	ANVILS SET
110710001	METRIC 60 0.4-7mm 6pcs
110720001	WHITWORTH 55 60-3.5 TPI 10pcs

OPTIONAL ACCESSORIES

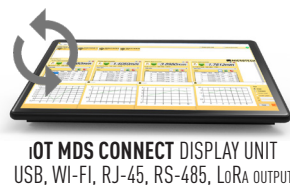

DOWNLOAD APP



- Industry 4.0 adopted sub-micron Tablet indicator with computerized MICS system with 2.4" color Touchscreen
- Patents UA126928, UA99686, UA2022050400
- Functions: On-line Graphic, Analog scale, Go/NoGo, Max/Min, Formula, Timer, Linear correction, Temperature correction
- Measuring HUB: Wireless MICROTECH instrument connection, Synchronization, 2D mode, 2D Graph, Probe mode, Compensation
- Memory manager: 2000 values, Folders system, Statistics mode, Memory data transfer
- Quick reading system (50 value/sec)
- **4 MODES DATA TRANSFER:** WIRELESS to MDS app (Windows, Android, iOS, MacOS); WIRELESS HID, WIRELESS HID+MAC, USB HID
- Calibration certificate included (ISO17025 (Iac MRA))

RANGE UP TO 150MM

Item No	Range		Reso- lution	Accu- racy.	Hyste- resis	Force	2D connect	Measuring HUB	Graphic	Analog scale	Preset	Go/NoGo	Max/Min	Formula	Timer	Temp comp	Linear corr	Calibr date	FW update	Recharge	Memory	WIRELESS	USB													
	mm	inch																						mm	µm	µm	N									
120139135	0-12,5	0-0.5"	0,0001	±3,0	0,5	0,6-1	•	•	•	•	•	•	•	•	•	•	•	•	•	•	Folders / 2000 val	Long range / HID	USB HID / Update													
120139137				±2,0			•	•	•	•	•	•	•	•	•	•	•	•	•	•				•	•											
120139138				±1,6			•	•	•	•	•	•	•	•	•	•	•	•	•	•				•	•	•										
120139139				±1,2			•	•	•	•	•	•	•	•	•	•	•	•	•	•				•	•	•										
120139257	0-25,4	0-1"		±3,0			0,5	0,7-1.2	•	•	•	•	•	•	•	•	•	•	•	•				•	•	•	Folders / 2000 val	Long range / HID	USB HID / Update							
120139258				±2,0					•	•	•	•	•	•	•	•	•	•	•	•				•	•	•				•						
120139259				±1,6					•	•	•	•	•	•	•	•	•	•	•	•				•	•	•				•	•					
120139505				±5,0					•	•	•	•	•	•	•	•	•	•	•	•				•	•	•				•	•					
120139508	0-50,8	0-2"		±3,0					0,5	1,2-2,2	•	•	•	•	•	•	•	•	•	•				•	•	•				•	•	Folders / 2000 val	Long range / HID	USB HID / Update		
120139509				±2,0							•	•	•	•	•	•	•	•	•	•				•	•	•				•	•				•	
120139905				±7,0							•	•	•	•	•	•	•	•	•	•				•	•	•				•	•				•	•
120139907				±5,0							•	•	•	•	•	•	•	•	•	•				•	•	•				•	•				•	•
120139908	0-100	0-4"	±3,0	0,5	3,2-5,2	•					•	•	•	•	•	•	•	•	•	•	•	•	•	•	Folders / 2000 val	Long range / HID				USB HID / Update						
120139503			±9,0			•					•	•	•	•	•	•	•	•	•	•	•	•	•	•							•					
120139505			±7,0			•					•	•	•	•	•	•	•	•	•	•	•	•	•	•							•				•	
120139507			±5,0			•					•	•	•	•	•	•	•	•	•	•	•	•	•	•							•				•	

- Industry 4.0 adopted sub-micron Computerized indicator with computerized MICS system with 1,54" color Touchscreen
- Functions: Go/NoGo, Max/Min, Formula, Timer, Linear correction, Temperature correction, Resolution selecting, Connection status
- Memory manager: 2000 values, Folders system, Statistics mode, Memory data transfer
- Quick reading system (50 value/sec)
- **4 MODES DATA TRANSFER:** WIRELESS to MDS app (Windows, Android, iOS, MacOS); WIRELESS HID, WIRELESS HID+MAC, USB HID
- Calibration certificate included (ISO17025 (Ilac MRA))



Item No	Range		Resol.	Accu- racy	Hyste- resis	Force	Preset	Go/NoGo	Max/Min	Formula	Timer	Temp comp	Linear corr	Calibr date	FW update	Recharge	Memory	WIRELESS	USB								
	mm	inch																		mm	μm	μm	N				
120129133	0-13	0-0,5"	0,0001	±5	0,5	0,6-1	•	•	•	•	•	•	•	•	•	•	Folders / 2000 val Long range / HID USB HID / Update	WIRELESS	USB								
120129135				±3			•	•	•	•	•	•	•	•	•	•				•							
120129137				±2			•	•	•	•	•	•	•	•	•	•				•							
120129138	±1.6	•		•		•	•	•	•	•	•	•	•	•													
120129252	0-25,4	0-1"		±7		0,5	0,7-1,2	•	•	•	•	•	•	•	•	•				•	•	Folders / 2000 val Long range / HID USB HID / Update	WIRELESS	USB			
120129253				±5				•	•	•	•	•	•	•	•	•				•	•						
120129257				±3				•	•	•	•	•	•	•	•	•				•	•						
120129258	±2	•		•		•	•	•	•	•	•	•	•	•	•												
120129503	0-50,8	0-2"		±10		0,5	1,2-2,2	•	•	•	•	•	•	•	•	•				•	•				Folders / 2000 val Long range / HID USB HID / Update	WIRELESS	USB
120129504				±6				•	•	•	•	•	•	•	•	•				•	•						
120129507			±4	•	•			•	•	•	•	•	•	•	•	•	•										
120129508			±3	•	•			•	•	•	•	•	•	•	•	•	•										

## OPTIONAL ACCESSORIES

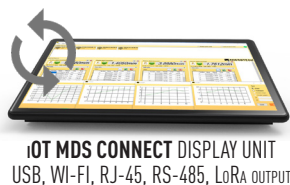

DOWNLOAD APP



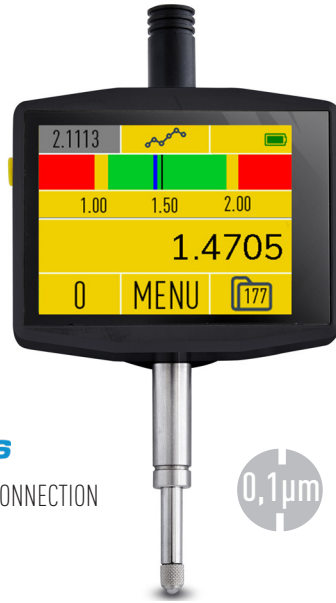

WIRELESS TO MDS APP  
WIRELESS HID+MAC  
USB HID



MEASURING HUB  
MICROTECH DEVICES CONNECT

**Modbus**  
MODBUS PLC CONNECTION

0,1 μm

Item No	Range		Reso- lution	Accu- racy.	Hyste- resis	Force	2D connect	Measuring HUB	Graphic	Analog scale	Preset	Go/NoGo	Max/Min	Formula	Timer	Temp comp	Linear corr	Calibr date	FW update	Recharge	Memory	WIRELESS	USB	PLC	
	mm	inch																							mm
120139137M	0-12,5	0-0,5"	0,0001	±2,0	0,5	0,6-1	•	•	•	•	•	•	•	•	•	•	•	•	•	•	•	•	•	•	
120139258M	0-25,4	0-1"		±2,0		0,7-1,2	•	•	•	•	•	•	•	•	•	•	•	•	•	•	•	•	•	•	•
120139508M	0-50,8	0-2"		±3,0		1,2-2,2	•	•	•	•	•	•	•	•	•	•	•	•	•	•	•	•	•	•	•
120139907M	0-100	0-4"		±5,0		1,2-2,2	•	•	•	•	•	•	•	•	•	•	•	•	•	•	•	•	•	•	•
120139505M	0-150	0-6"		±8,0		3,2-5,2	•	•	•	•	•	•	•	•	•	•	•	•	•	•	•	•	•	•	•

ROTATING TABLET INDICATOR



0,1 μm



WIRELESS TO MDS APP  
WIRELESS HID+MAC  
USB HID



MEASURING HUB  
MICROTECH DEVICES CONNECT

Item No	Range		Reso- lution	Accu- racy.	Hyste- resis	Force	2D connect	Measuring HUB	Graphic	Analog scale	Preset	Go/NoGo	Max/Min	Formula	Timer	Temp comp	Linear corr	Calibr date	FW update	Recharge	Memory	WIRELESS	USB	
	mm	inch																						mm
120139137R	0-12,5	0-0,5"	0,0001	±2,0	0,5	0,6-1	•	•	•	•	•	•	•	•	•	•	•	•	•	•	•	•	•	
120139258R	0-25,4	0-1"		±2,0		0,7-1,2	•	•	•	•	•	•	•	•	•	•	•	•	•	•	•	•	•	•
120139508R	0-50,8	0-2"		±3,0		1,2-2,2	•	•	•	•	•	•	•	•	•	•	•	•	•	•	•	•	•	•

- Industry 4.0 adopted sub-micron Computerized dial comparator with 0.1 micron resolution
- Functions: Go/NoGo, Max/Min, Formula, Timer, Linear correction, Temperature correction, Resolution selecting, Connection status
- Memory manager: 2000 values, Folders system, Statistics mode, Memory data transfer
- Quick reading system (50 value/sec)
- **4 MODES DATA TRANSFER:** WIRELESS to MDS app (Windows, Android, iOS, MacOS); WIRELESS HID, WIRELESS HID+MAC, USB HID
- Calibration certificate included (ISO17025 (Ilac MRA))



0,1 μm

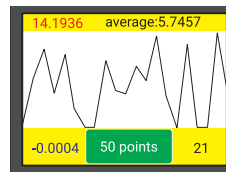

ON-LINE GRAPHIC MODE

### OPTIONAL ACCESSORIES



ACCESSORIES FOR DATA TRANSFER



IoT MDS CONNECT DISPLAY UNIT  
USB, WI-FI, RJ-45, RS-485, LoRa OUTPUT

Item No	Range	Resolution	Accuracy	Force	Stem D	Preset	Go/NoGo	Max/Min	Formula	Timer	Linear corr	Calibr date	FW update	Recharge	Memory	WIRELESS	USB
	mm	mm	μm	N	mm												
120120288	0.1	0,0001	±0.5	1.8-2.2	28	•	•	•	•	•	•	•	•	•	•	•	•

### DOWNLOAD APP



## DIAL COMPARATOR

Item No	Range	Resolution	Accuracy	Force	Stem D
	mm	mm	μm	N	mm
120120280	0.03	0,001	±0.3	1.8-2.2	28



- High quality indicator with IP65 proof
- PRESET, mm/inch, HOLD function
- USB data transfer
- CR2032 3V battery
- **Calibration** certificate included (ISO17025 (Ilac MRA))



**RANGE UP TO 150MM**

Item No	Range		Resolution		Accuracy		Force	Proof	mm/inch	Preset	ABS	USB DATA
	mm	inch	mm	inch	µm	N						
120125131	0-12,7	0-0,5"	0,01	0.0005"	±10	0.6-1	IP65	•	•	•	•	
120125132					±6			•	•	•	•	
120125133					±4			•	•	•	•	
120125134					±3			•	•	•	•	
120125135					±2			•	•	•	•	
120125250	0-25,4	0-1"	0,01	0.0005"	±20	0.7-1.2		•	•	•	•	
120125251					±10			•	•	•	•	
120125252					±6			•	•	•	•	
120125253					±4			•	•	•	•	
120125500	0-50,8	0-2"	0,01	0.0005"	±20	1.2-2.2		•	•	•	•	
120125502					±7			•	•	•	•	
120125503					±5			•	•	•	•	
120125901	0-100	0-4"	0,01	0.0005"	±20	3-5		•	•	•	•	
120125902					±12			•	•	•	•	
120125904					±8			•	•	•	•	
120125951					±30		•	•	•	•		
120125952	0-150	0-6"	0,01	0.0005"	±20	•	•	•	•			
120125954					±10	•	•	•	•			

**OPTIONAL ACCESSORIES**



**120125000** USB HID DATA TRANSFER CABLE  
DIRECT DATA TRANSFER, LIKE A KEYBOARD



**STANDS**

**MADE IN UKRAINE**

- Top quality dial indicator
- 0.01 or 0.001mm resolution
- Jeweled bearing
- Modification with SHOCKPROOF & WATERPROOF
- With adjustable tolerance markers
- Calibration certificate included (ISO17025 (Ilac MRA))



Item No	Range	Resolution	Accuracy	Bezel D	Shockproof	Jeweled	Tol. markers	Waterproof	Rubber sleeve
	mm	mm	µm	mm					
120121010	0-1	0,001	±3	60		•	•		
120121100	0-10	0,01	±15			•	•		
120120100					•	•	•	•	
120121300	0-30		±25			•	•		
120121500	0-50		±35			•	•		
120121990	0-100		±40			•	•		

## OPTIONAL ACCESSORIES



STANDS

- Industry 4.0 adopted Display Unit with computerized MICS system with 2,4" or 3,5" color Touchscreen
- Up to 4 Probes connection or 4 WIRELESS connections
- Functions: Go/NoGo, Max/Min, Formula, Timer, Linear correction, Temperature correction, Resolution selecting, Connection status
- Memory manager: 2000 values, Folders system, Statistics mode, Memory data transfer
- **4 MODES DATA TRANSFER:** WIRELESS to MDS app (Windows, Android, iOS, MacOS); WIRELESS HID, WIRELESS HID+MAC, USB HID
- Calibration certificate included (ISO17025 (Ilac MRA))

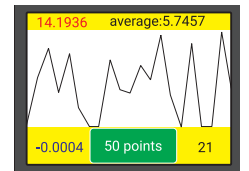

**ON-LINE GRAPHIC MODE**

DOWNLOAD APP



Item No	INPUT CONNECTION		Data output			Memory	Display	Battery	Footswitch
	CAPACITIVE PROBES	WIRELESS	MODBUS	WIRELESS	USB				
299999011	1	1	option	Wireless to MDS, Wireless HID, Wireless HID+MAC	USB HID	Folders 2000 vol Statistics	2.4"	Recharge Li-Pol	option
299999024	4	max 4							



## CAPACITIVE LINEAR PROBES

Item No	Range		Resol.	Accu- racy	Hyste- resis	Force	Cable length	Clamping	Output socket
	mm	inch							
120129101P	0-1	0-0.05"	0,0001	±0.5	0,3	1.8-2.2	2	Ø 28-h6	7 pin
120129137P	0-13	0-0.5"		±2	0,5	0,6-1			
120129258P	0-25	0-1"		±2		0,7-1.2	Optional 10	Ø 8-h6	
120129508P	0-50	0-2"		±3	1,2-2,2				
120129907P	0-100	0-4"		±5	1	3.2-5.2			
120129507P	0-150	0-6"		±7					



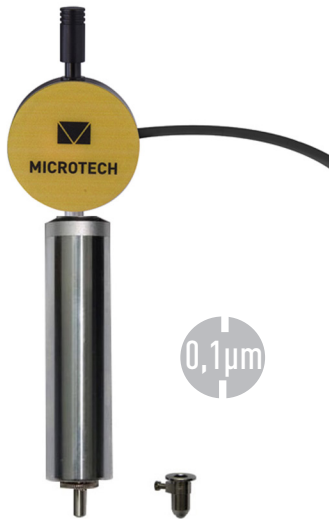

WIRELESS TO MDS APP  
WIRELESS HID+MAC  
USB HID



MEASURING HUB  
MICROTECH DEVICES CONNECT

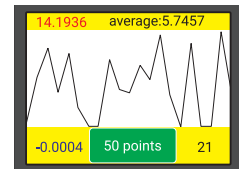

ON-LINE  
GRAPHIC MODE

Item No	Range		Resol.	Accu- racy	Cable length	2D connect	Measuring HUB	Graphic	Analog scale	Preset	Go/NoGo	Max/Min	Formula	Timer	Temp comp	Linear corr	Calibr date	FW update	Recharge	Memory	WIRELESS	USB	
	mm	inch	mm	μm	m																		
120129101L	0-1	0-0.05"	0,0001	±0,5	2 (option up to 10m)	•	•	•	•	•	•	•	•	•	•	•	•	•	•	•	Folders / 2000 val Long range / HID USB HID / Update		
120129137L	0-12,5	0-0.5"		±2		•	•	•	•	•	•	•	•	•	•	•	•	•	•	•			•
120129258L	0-25,4	0-1"		±2		•	•	•	•	•	•	•	•	•	•	•	•	•	•	•			•
120129508L	0-50,8	0-2"		±3		•	•	•	•	•	•	•	•	•	•	•	•	•	•	•			•
120129907L	0-100	0-4"		±5		•	•	•	•	•	•	•	•	•	•	•	•	•	•	•			•

DOWNLOAD APP



## OPTIONAL ACCESSORIES

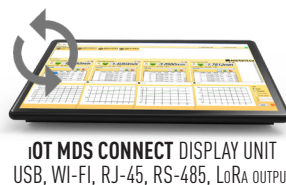

- Industry 4.0 adopted sub-micron Computerized test indicator with computerized MICS system color Touchscreen
- Patents UA126928, UA99686
- Functions: Go/NoGo, Max/Min, Formula, Timer, Linear correction, Temperature correction, Resolution selecting, Connection status
- Memory manager: 2000 values, Folders system, Statistics mode, Memory data transfer
- Quick reading system (50 value/sec)
- 4 MODES DATA TRANSFER: WIRELESS to MDS app (Windows, Android, iOS, MacOS); WIRELESS HID, WIRELESS HID+MAC, USB HID
- Calibration certificate included (ISO17025 (Ilac MRA))



Item No	Range		Resol.	Accu- racy	Probe	Measu- ring Force	Preset	Go/NoGo	Max/Min	Formula	Timer	Temp comp	Linear corr	Calibr date	FW update	Recharge	Memory	WIRELESS	USB	
	mm	inch	mm	µm	mm	N														
120129018	-0.8 +0.8	-0.03" +0.03"	0,0001	±5	12,8	0,1-0,18	•	•	•	•	•	•	•	•	•	•	•	•	•	•

SUB-MICRON COMPUTERIZED TEST INDICATOR EXTERNAL PROBE

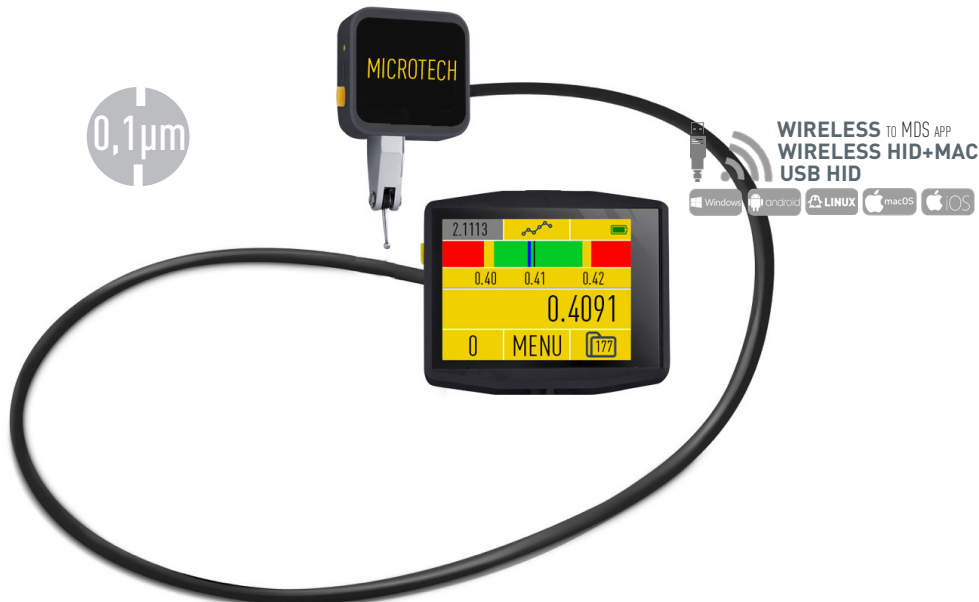

Item No	Range		Resol.	Accu- racy	Probe	Measu- ring Force	Cable length	Preset	Go/NoGo	Max/Min	Formula	Timer	Temp comp	Linear corr	Calibr date	FW update	Recharge	Memory	WIRELESS	USB	
	mm	inch	mm	µm	mm	N	m														
120129019L	-0.8	-0.03"	0,0001	±5	12,8	0,1-0,18	2	•	•	•	•	•	•	•	•	•	•	•	•	•	•
120129019L10	+0.8	+0.03"			12,8		10	•	•	•	•	•	•	•	•	•	•	•	•	•	•

DOWNLOAD APP



MADE IN UKRAINE

## DIAL TEST INDICATOR

- Top quality dial test indicators
- Contrast black dial face
- 0.01 or 0.002 mm resolution
- Adjustable bezel for zeroing
- Jeweled
- Completing with dovetail stem 6 and 8mm
- **Calibration** certificate included (ISO17025 (Ilac MRA))



Item No	Range	Reso- lution	Repea- tability	Dial face	Accu- racy	Probe	Measuring Force	Scale Diameter
	mm	mm	mm		$\mu\text{m}$	mm		
120131080	0-0.8	0,01	3	40-0-40	$\pm 10$	12,8	0,1-0,18	32
120131020	0-0.2	0,002	1,5	100-0-100	$\pm 6$	12,8		40

## 3D TOUCH TRIGGER PROBE

- Touch-trigger Probes for using in motorized height gauges
- Completed with stylus
- Intechangeable stylus

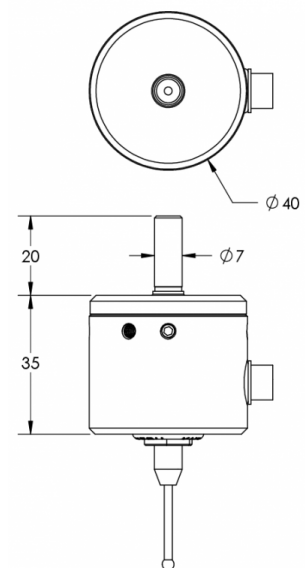
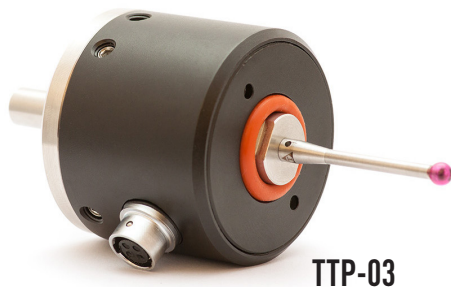

Item No	Type	Repeatability unidirect.	Force			Protection	Shank D	Stylus	Signal voltage
		$\mu\text{m}$	X	Y	Z				
121000012	TTP-03	2	1	1	5	IP64	7	Ruby D4mm, L31mm, M2.5	3-48



Item No	Base	Measuring table	Flatness	Column	Fine adjustment	Clamp hole D	Weight
	mm	mm	μm	mm	mm	mm	kg
161002020	149x90x30	D60	2	D22x180	8	8	2



### HYDRAULIC MAGNETIC STAND

- Aluminium arm
- Hydraulic stand
- High lock force holder

Item No	Magnetic force	Base	Length	Clamp hole D	Weight
	kgf	mm	mm	mm	kg
161110900	80	74x50x55	400	6/8	2



### UNIVERSAL MAGNETIC STAND

- Magnetic Force up to 130kg
- Universal stand
- Customized modifications for requirement

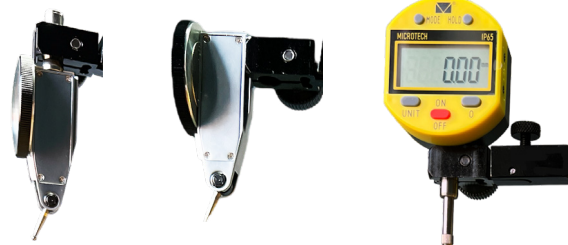

Item No	Magnetic force	Base	Length	Clamp hole D	Weight
	kgf	mm	mm	mm	kg
161108800	80	50x60x55		8	1,4
161113800	130	50x120x55	380	8	3,5

## HARDENED MAGNETIC STAND

MICROTECH 

- Height of stand up to 1500mm
- Magnetic Force up to 520kg
- Customized modifications for request

Item No	Magnetic force	Base	Main stem	Assistant stem	Clamp hole D	Fine adjustment
	kgf	mm	mm	mm	mm	
161108000	80	50x60x55	170x12	150x10	6/8	•
161113310	130	50x120x55	355x20	200x14		•
161113410	130	50x120x55	400x25	250x18		•
161113610			630x32	500x25		•
161126210	260	200x120x70	800x51	600x32		•
161126310			1000x51	600x32		•
161152410	520	250x250x80	1250x76	800x51		•
161152510			1500x76	800x51		•



## FLEXIBLE MAGNETIC STAND

- Magnetic Force up to 130kg
- Flexible stand
- Customized modifications for requirement

Item No	Magnetic force	Base	Length	Clamp hole D	Weight
	kgf	mm	mm	mm	kg
161208010	80	50x60x55	320	6/8	1,4
161213010	130	50x120x55			3,5



## MICROMETER STAND

- Micrometer stand for fixing micrometers and snap gauges
- Customized modifications for requirement

Item No	Micrometer range	Depth	Adjustable angle	Weight
		mm		kg
161801500	up to 100mm	4-20	•	1,2



- FILM Thickness gauge
- Dial, Digital or Computerized electronics
- MODIFICATION with **WIRELESS** data transfer **3 MODES DATA TRANSFER**: **WIRELESS** to MDS app (Windows, Android, iOS, MacOS); **WIRELESS HID, WIRELESS HID+MAC**
- Calibration certificate included (ISO17025 (Ilac MRA))



Item No	Range	Depth	Roll width	Resolution	Accuracy	Indicator	Data output
	mm	mm	mm	mm	µm		
137010105	0-10	100	7	0,01	±20	Dial	-
137010106				0,001	±12	Digital	
137010108				0,0001	±10	Computerized	

- WALL Thickness gauge
- Contact point 6mm
- Dial, Digital or Computerized electronics
- MODIFICATION with **WIRELESS** data transfer **3 MODES DATA TRANSFER**: **WIRELESS** to MDS app (Windows, Android, iOS, MacOS); **WIRELESS HID, WIRELESS HID+MAC**
- Calibration certificate included (ISO17025 (Ilac MRA))



Item No	Range	Resolution	Accuracy	Contact point	Indicator	Data output
	mm	mm	µm	mm		
137011100	0-10	0,01	±20	D 6	Dial	-
137011106		0,001	±12		Digital	
137011107		0,0001	±10		Computerized	

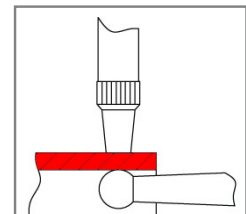

**OPTIONAL ACCESSORIES**

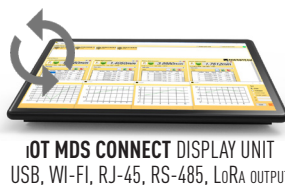

**DOWNLOAD APP**



# CONSTANT PRESSURE THICKNESS GAUGES

- CONSTANT pressure Thickness gauge
- Dial, Digital or Computerized electronics
- MODIFICATION with **WIRELESS** data transfer **3 MODES DATA TRANSFER: WIRELESS** to MDS app (Windows, Android, iOS, MacOS); **WIRELESS HID, WIRELESS HID+MAC**
- **Calibration** certificate included (ISO17025 (Ilac MRA))



Item No	Range	Resolution	Accuracy	Force	Display	Data output
	mm	mm	µm	mPA		
137320101	0-1	0,001	±5	0.1	Dial	-
137320105	0-5		±5		Digital	
137320108		0,0001	±3	Computerized	<b>WIRELESS +USB</b>	

## 2D THICKNESS GAUGE

- **2D Thickness gauge** for deep and complex shapes measuring. Control Z (jaws depth) and X (depth and range) axes
- **Functions:** Go/NoGo, Max/Min, Formula, Timer, Linear correction, Temperature correction, Resolution selecting, Connection status
- **Memory manager:** 2000 values, Folders system, Statistics mode, Memory data transfer
- **3 MODES DATA TRANSFER: WIRELESS** to MDS app (Windows, Android, iOS, MacOS); **WIRELESS HID, WIRELESS HID+MAC**
- **Calibration** certificate included (ISO17025 (Ilac MRA))

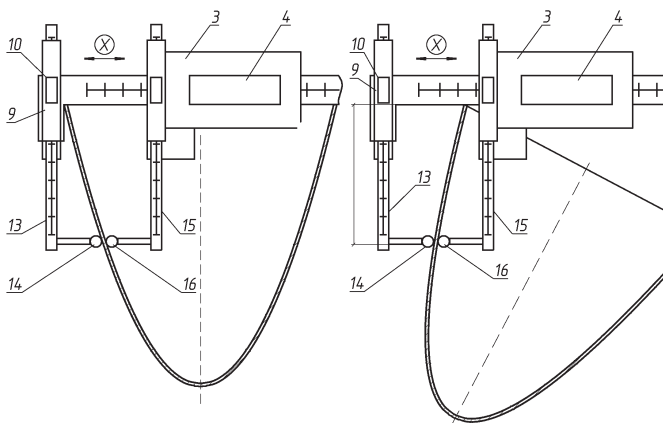

Item No	Range		Resolution		Accuracy		Display	2D connect	Probe connect	On-line Graphic	Analog scale	Preset	Go/NoGo	Max/Min	Formula	Timer	Temp comp	Linear corr	Calibr date	Connect. status	Recharge batt	Memory	Wireless	USB	Color Display
	X	Z	Z	X	Z	X																			
	mm	mm	mm	mm	µm	µm																			
149020307	0-300	0-150	0,001	0.005	±30	±30	Digital	•	•	•	•	•	•	•	•	•	•	•	•	•	•	•	•	•	•
149020507	0-500				±50	±30		•	•	•	•	•	•	•	•	•	•	•	•	•	•	•	•	•	•

- Dial thickness gauge with range up to 100mm and depth up to 800mm
- Optional contact point or gauge configuration for request
- Calibration certificate included (ISO17025 (Ilac MRA))

**CUSTOM RANGE AND DEPTH FOR REQUEST**

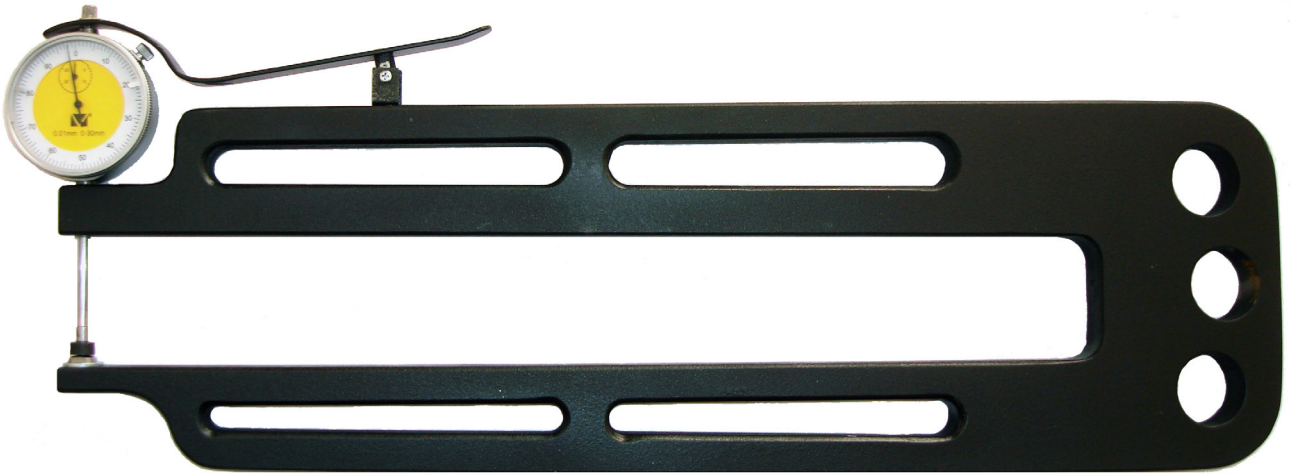

Item No	Range	Reso- lution	Accur- acy	Depth	Contact points D	
					Standard	Optional
					mm	mm
137001021	0-1	0.001	±5	25	6,35	
137010121	0-10	0.01	±30	120	10	Flat d 12, 16, 20, 25, 30, 35, 40 Point D 0.3 Blade 0.7
137020121	0-20		±40	120		
137025201	0-25		±40	200		
137025401			±50	400		
137050201	0-50		±50	200		
137050301			±60	300		
137050401			±70	400		
137050601			±80	600		
137050801			±90	800		
137100201			0-100	±50		
137100401	±70	400				
137100601	±80	600				
137100801	±100	800				

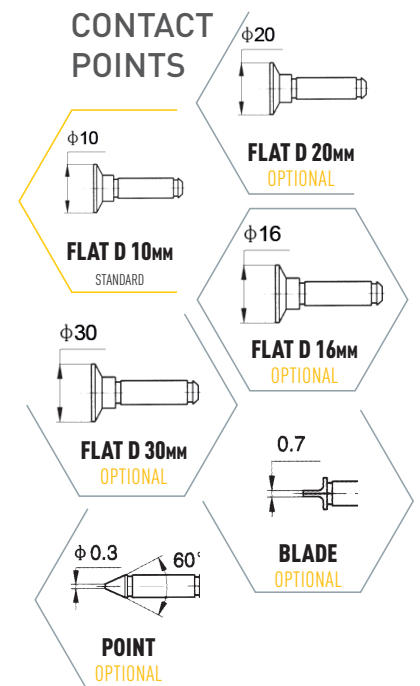



- Digital thickness gauge with range up to 300mm and depth up to 800mm
- Micron Digital indicator IP65 proof with PRESET function
- Optional contact point or gauge configuration for request
- **Calibration** certificate included (ISO17025 (Ilac MRA))



**CUSTOM RANGE AND DEPTH FOR REQUEST**



Item No	Range	Reso- lution	Accu- racy	Depth	Contact points D	
					Standard	Optional
	mm	mm	µm	mm	mm	mm
137001028	0-1	0.001	±3	25	6,35	Flat d 12, 16, 20, 25, 30, 35, 40 Point D 0.3 Blade 0.7
137010128	0-10		±12	120	10	
137020128	0-20		±15	120		
137025208	0-25		±18	200		
137025408			±25	400		
137050208	0-50		±20	200		
137050308			±25	300		
137050408			±30	400		
137050608			±35	600		
137050808			±40	800		
137100208	0-100		±20	200		
137100408			±30	400		
137100608			±40	600		
137100808	0-150		±55	800		
137150408			±55	400		
137150808	±80		800			
137300408	150-300	±70	400			
137300808		±95	800			

### OPTIONAL ACCESSORIES



120125000 USB HID DATA TRANSFER CABLE  
DIRECT DATA TRANSFER, LIKE A KEYBOARD

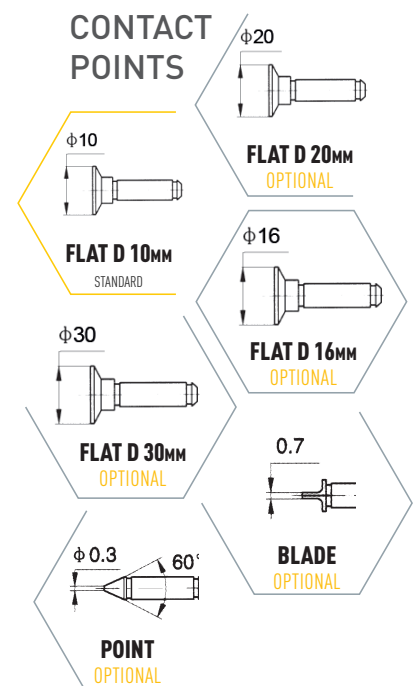

- Industry 4.0 adopted sub-micron Computerized thickness gauge with range up to 300mm and depth up to 800mm
- Functions: Go/NoGo, Max/Min, Formula, Timer, Linear correction, Temperature correction, Resolution selecting, Connection status
- Memory manager: 2000 values, Folders system, Statistics mode, Memory data transfer
- Quick reading system (50 value/sec)
- **4 MODES DATA TRANSFER:** WIRELESS to MDS app (Windows, Android, iOS, MacOS); WIRELESS HID, WIRELESS HID+MAC, USB HID
- Calibration certificate included (ISO17025 (Ilac MRA))



**CUSTOM RANGE AND DEPTH FOR REQUEST**

Item No	Range	Reso- lution	Accu- racy	Depth	Contact points D		Preset	Go/NoGo	Max/Min	Formula	Timer	Temp comp	Linear corr	Calibr date	FW update	Recharge	Memory	WIRELESS	USB		
					Standard	Optional															
137001027	0-1	0.0001	±3	25	6,35		•	•	•	•	•	•	•	•	•	•	•	•	•	•	
137010127	0-10		±8	120		•	•	•	•	•	•	•	•	•	•	•	•	•	•	•	•
137020127	0-20		±12	120		•	•	•	•	•	•	•	•	•	•	•	•	•	•	•	•
137025207	0-25		±15	200		•	•	•	•	•	•	•	•	•	•	•	•	•	•	•	•
137025407			±20	400		•	•	•	•	•	•	•	•	•	•	•	•	•	•	•	•
137050207	0-50		±18	200		•	•	•	•	•	•	•	•	•	•	•	•	•	•	•	•
137050307			±20	300		•	•	•	•	•	•	•	•	•	•	•	•	•	•	•	•
137050407			±22	400		•	•	•	•	•	•	•	•	•	•	•	•	•	•	•	•
137050607			±30	600		•	•	•	•	•	•	•	•	•	•	•	•	•	•	•	•
137050807			±35	800		•	•	•	•	•	•	•	•	•	•	•	•	•	•	•	•
137100207	0-100		±15	200		•	•	•	•	•	•	•	•	•	•	•	•	•	•	•	•
137100407			±24	400		•	•	•	•	•	•	•	•	•	•	•	•	•	•	•	•
137100607			±32	600		•	•	•	•	•	•	•	•	•	•	•	•	•	•	•	•
137100807			±44	800		•	•	•	•	•	•	•	•	•	•	•	•	•	•	•	•
137150407	0-150		±50	400		•	•	•	•	•	•	•	•	•	•	•	•	•	•	•	•
137150807			±70	800		•	•	•	•	•	•	•	•	•	•	•	•	•	•	•	•
137300407	150-300	±60	400		•	•	•	•	•	•	•	•	•	•	•	•	•	•	•	•	
137300807		±85	800		•	•	•	•	•	•	•	•	•	•	•	•	•	•	•	•	

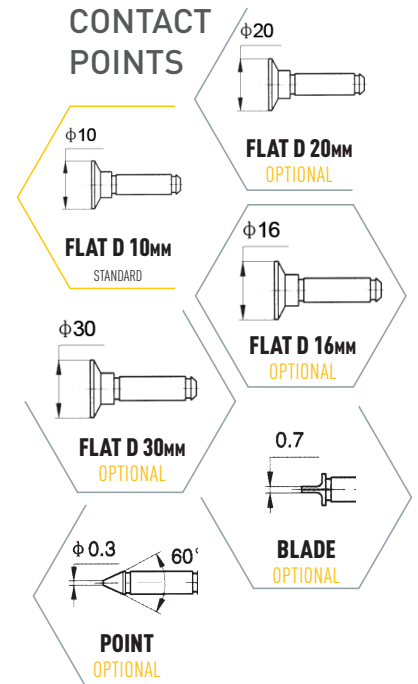

**OPTIONAL ACCESSORIES**

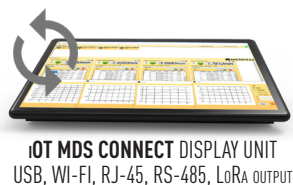

**DOWNLOAD APP**



# SOFT MATERIALS THICKNESS GAUGE



- Digital thickness gauge for soft materials
- Micron Digital indicator IP65 proof with PRESET function
- Optional contact point or gauge configuration for request
- **Calibration** certificate included (ISO17025 (Ilac MRA))

**CUSTOM RANGE AND ANVILS FOR REQUEST**

### OPTIONAL ACCESSORIES



120125000 USB HID DATA TRANSFER CABLE  
DIRECT DATA TRANSFER, LIKE A KEYBOARD

Item No	Standard	Material	Range	Resol.	Depth	Accuracy	Base	Measuring surface		Force	
			mm	mm	mm	mm	mm	mm	cm <sup>2</sup>	N	kPa
137331201	ASTM D1777-1	woven fabrics knitted fabrics	0-10	0,001	50	0,02	D38	D28,7	6,466	2,68±0,13	4,14±0,21
137331202	ASTM D1777-2	coated fabrics, narrow fabrics, webbing tapes, ribbons braids				0,015	D38	D9,5	0,7085	1,66±0,05	23,4±0,7
137331203	ASTM D1777-3	films, glass cloths, glass tapes.				0,002/0,012	D19	D6,3	0,3117	5,36±0,42	172±14
137331204	ASTM 3767-03-B	rubber 30-100mm				0,007	40x30	40x30	12	8±2	6,7
137331205	ASTM D3767-A1	rubber				0,01/ 1%	R12,5	R12,5 D10		0,8±0,1	
137331206	DIN 53370-F	plastic films				2% / 0,12	D10	D10	0,785	3,93	50
137331207	DIN 53370-P	foil				0,01-0,015	D10	R30 D5		0,5	
137331208	DIN EN 1849-2	waterproofing sheet flexible sheets				0,01	D10	D10	0,785	1,57	20±10
137331209	ISO 3034	corrugated fiberboard				0,02	D35,7	D35,7	10	20±0,5	20±0,5
137331210	ISO 4593-R	plastic, film and sheeting				0,001 / 0,002/	D10	R30/D5		0,5	
137331211	ISO 4593-P	plastic, film and sheeting				0,003/ 0,012	D10	D10	0,785	1	12,74
137331212	ISO 23529-A	rubber & elastomer				1%	D100	D10	0,785	0,8±0,16	10±2
137331213	ASTM D3767-03-A	<35IRHD									
	ISO 23529-A	rubber & elastomer	0,01	D100	D10	0,785	1,76±0,35	22±5			
	ASTM D3767-03-A	>35IRHD									

# BRAILLE DOT THICKNESS GAUGE

- Digital thickness gauge for Braille dot height
- Micron Digital indicator IP65 proof with PRESET function
- **Calibration** certificate included (ISO17025 (Ilac MRA))



Item No	Range	Reso- lution	Accuracy	Depth	Contact points D
	mm	mm	µm	mm	mm
137022078	0-10	0.001	±5	60	7.8

- **Industry 4.0** adopted sub-micron Computerized thickness gauge for soft materials
- **Functions:** Go/NoGo, Max/Min, Formula, Timer, Linear correction, Temperature correction, Resolution selecting, Connection status
- **Memory manager:** 2000 values, Folders system, Statistics mode, Memory data transfer
- **Quick reading system** (50 value/sec)
- **4 MODES DATA TRANSFER:** WIRELESS to MDS app (Windows, Android, iOS, MacOS); WIRELESS HID, WIRELESS HID+MAC, USB HID
- **Calibration** certificate included (ISO17025 (Ilac MRA))



## CUSTOM RANGE AND DEPTH FOR REQUEST

Item No	Standard	Material	Range	Resol.	Depth	Accuracy	Base	Measuring surface		Force		Timer auto
			mm	mm	mm	mm	mm	mm	mm	cm <sup>2</sup>	N	kPA
137331231	ASTM D5199-01-B	geomembranes	0-10	0,0001	50	0,02	D6,35	D6,35	0,3167	0,633±0,006	20±0,2	5
137331232	ASTM D5199-01-A	geotextiles, geonets, geocomposite drainage materials				0,02	D76,4	D56,4	25	5±0,05	2±0,02	5
137331233	ISO 2286-3	rubber, plastic coated fabrics				0,02	D60	D10	0,785	1,88±1,9	24±2,4	30
137331234	ISO 2589	leather				0,015	D16 / D50	D10	0,785	3,85±0,1	49,1	5
137331235	ISO 5084-0	textiles				0,01-0,02	D100	D50,5	20	2±0,02	1±0,01	30
137331236	ISO 5084-A3	textiles				0,01-0,02	D100	D50,5	20	5±0,05	1±0,01	30
137331237	ISO 9863-1-C	polymeric and bituminous geosynthetic barriers				0,02	D56,4	D56,4	25	50±0,5	20±02	5
137331238	ISO 9863-1	polymeric and bituminous geosynthetic of non-inifrom thickness				0,015	R 1	R 1	25	0,6±0,1		5

### OPTIONAL ACCESSORIES

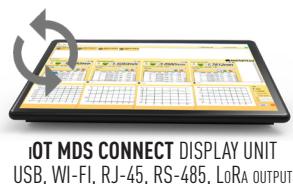

### DOWNLOAD APP



# SOFT MATERIALS THICKNESS STAND

MICROTECH 



WIRELESS TO MDS APP  
WIRELESS HID+MAC  
USB HID

Windows Android LINUX macOS iOS

0,1 μm



WIRELESS TO MDS APP  
WIRELESS HID+MAC  
USB HID

Windows Android LINUX macOS iOS

Item No	Standard	Material	Range	Resol.	Accuracy	Base	Measuring surface	Force		Timer auto	
			mm	mm	mm	mm	mm	cm <sup>2</sup>	N	kPA	sec.
137331251	ASTM D1777-1 ASTM D1777-5	woven fabrics knitted fabrics	0-25	0,0001	0,015	D58	D28,7±0,02	6,47	2,68±0,13 0,45±0,05	4,14 0,7	
137331252	ASTM D1777-2	coated fabrics, narrow fabrics, webbing tapes, ribbons braids	0-25		0,012	D58	D9,5±0,02	0,7085	1,66±0,05	23,4±0,7	
137331253	ASTM D1777-3	films, glass cloths, glass tapes.	0-25		0,002-0,01	D58	D6,3	0,312	5,36±0,42	172±14	
137331254	ASTM D1777-4	glass fiber mat	0-25		0,02	150x100	D57,15±0,02	25,65	48,48±1,8	18,9±0,7	
137331255	ASTM D3767-03-A1	rubber	0-25		1% / 0,01	R1 D58	R12,5 D10		0,8±0,1	1%	
137331256	ASTM D3767-03-A ISO 23529-A	rubber & elastomer <35IRHD	0-25		0,01 / 1%	300x200	D10	0,785	0,8±0,16 1,76±0,35	10±2 22±4,4	
137331257	ASTM D5199-01-A	geotextiles, geonets, geocomposite drainage materials	0-25		0,012	150x100	D56,4	25	5±0,05	2±0,02	5
137331258	ASTM D5199-01-B	geomembranes	0-25		0,012	D58	D6,35	0,3167	0,633±0,006	20±0,2	5
137331260	DIN EN 1849-2	waterproofing sheet flexible sheets	0-25		1% / 0,01	D58	D10	0,785	1,57±0,785	20±10	
137331261	DIN 53370-P	foil	0-25		0,002-0,012	D58	R30 D5		0,5		
137331262	DIN 53370-F	plastic films	0-25		0,0002-0,012	D58	D10	0,785	3,93	50	
137331263	DIN 53855-1	compression of textile	0-50		0,01-0,02	300x200	D35,69 D56,34	10 25	0,49 / 2,45 1,23/ 6,13	0,51 / 2,55	60
137331264	EN 964-1	geotextiles	0-25		0,01-0,015	150x100	D56,42	25	5±0,04 50±0,4 500±4	2±0,02 20±0,2 200±2	30
137331265	ISO 534	paper, cardboard	0-25		0,5% / 0,0025/ 0,015	D58	D16	2	20±2	100±10	
137331266	ISO 2286-3	rubber, plastic coated fabrics	0-25		0,01	150x100	D10	0,785	0,393±0,039 0,785±0,079 1,88±0,19	5±0,5 10±1 24±2,4	30
137331267	ISO 2589	leather	0-25		0,01	D16 / D50	D10±0,05	0,785	3,85±0,1	49,1	5
137331268	ISO 3034	corrugated fiberboard	0-25		0,02	D35,7	D35,7	10	20±0,5	20±0,5	
137331269	ISO 4593-P	plastic, film and sheeting	0-25		0,001-0,003	D58	D10	0,785	1	12,74	
137331270	ISO 4594-R	plastic, film and sheeting	0-25		0,001-0,15	D58	R30 / D5		0,5±0,025		
137331271	ISO 5084-0	textiles	0-25		0,01-0,02	150x100	D50,5	20	2±0,02	1±0,01	30
137331272	ISO 5084-A2	textiles	0-25	0,01-0,025	300x200	D112,84	100	10±0,1	1±0,01	30	
137331273	ISO 9073-2	textiles, normal nonwovens	0-25	0,025	300x200	D56,42	25	0,25 1,25	0,1 0,5	10	
137331274	ISO 9073-2	textiles for bulky nonwovens > 20mm	0-150	0,05	400x250	200x200	400	0,8±0,02	0,02	10	
137331275	ISO 9863-1-D	polymeric and bituminous geosynthetic of non-inform thickness	0-25	0,003-0,01	R 1 D58	R 1		0,6±0,1		5	
137331276	ISO 9863-1-ABC	polymeric and bituminous geosynthetic barriers	0-25	0,01-0,015	150x100	D56,4	25	5±0,05 50±0,5 500±5	2±0,02 20±0,2 200±2	5	

- Industry 4.0 adopted External caliper gauge with computerized MICS system with 1,54" color Touchscreen
- **MODIFICATIONS of contacts:** CONE (R0.5/R0.75), POINT (R0.5), BALL (Ø1)
- **Functions:** Go/NoGo, Max/Min, Formula, Timer, Linear correction, Temperature correction, Resolution selecting, Connection status
- **Memory manager:** 2000 values, Folders system, Statistics mode, Memory data transfer
- **4 MODES DATA TRANSFER:** WIRELESS to MDS app (Windows, Android, iOS, MacOS); WIRELESS HID, WIRELESS HID+MAC, USB HID
- **Calibration certificate included (ISO17025 (Ilac MRA))**

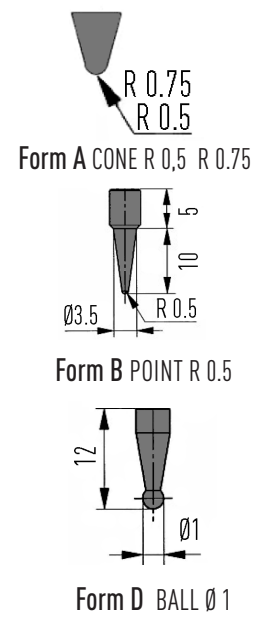

Item No	Range	Span	Depth	Groove depth	Measur contact	Contact points	Resolution	Repeatability	Accuracy	Preset	Go/NoGo	Max/Min	Formula	Timer	Temp comp	Linear corr	Calibr date	FW update	Recharge	Memory	WIRELESS	USB	
	mm	mm	mm	mm	mm	mm	mm	mm	µm														
<b>EXTERNAL COMPUTERIZED CALIPER GAUGE CONE contact (Form A)</b>																							
134201005	0-10	10	40	3	8	Cone R 0,5	0,0005	0,003	±10	•	•	•	•	•	•	•	•	•	•	•	•	•	
134202005	0-20	20	80	6,5	25	Cone R 0,75	0,001	0,005	±15	•	•	•	•	•	•	•	•	•	•	•	•	•	
134204005	20-40	20	80	6,5	25			0,005	±15	•	•	•	•	•	•	•	•	•	•	•	•	•	•
134206005	40-60	20	80	6,5	25			0,005	±15	•	•	•	•	•	•	•	•	•	•	•	•	•	•
<b>EXTERNAL COMPUTERIZED CALIPER GAUGE POINT contact (Form B)</b>																							
134202025	0-20	20	80	6,5	25	Point R 0.5	0,001	0,005	±20	•	•	•	•	•	•	•	•	•	•	•	•	•	
134204025	20-40	20	80	6,5	25			0,005	±20	•	•	•	•	•	•	•	•	•	•	•	•	•	•
134206025	40-60	20	80	6,5	25			0,005	±25	•	•	•	•	•	•	•	•	•	•	•	•	•	•
<b>EXTERNAL COMPUTERIZED CALIPER GAUGE BALL contact (Form D)</b>																							
134202045	0-20	20	80	6,5	25	Ball Ø 1	0,001	0,005	±20	•	•	•	•	•	•	•	•	•	•	•	•	•	
134204045	20-40	20	80	6,5	25			0,005	±20	•	•	•	•	•	•	•	•	•	•	•	•	•	•
134206045	40-60	20	80	6,5	25			0,005	±25	•	•	•	•	•	•	•	•	•	•	•	•	•	•
134208045	60-80	20	80	6,5	25			0,005	±30	•	•	•	•	•	•	•	•	•	•	•	•	•	•
134210045	80-100	20	80	6,5	25			0,005	±30	•	•	•	•	•	•	•	•	•	•	•	•	•	•
134205545	0-50	50	160	6,5	25	Ball Ø 2		0,01	±40	•	•	•	•	•	•	•	•	•	•	•	•		
<b>EXTERNAL COMPUTERIZED CALIPER GAUGE INTERCHANGEABLE BALL contact (Form D)</b>																							
134206075	0-60	20	80	6,5	variable	Ball Ø 1	0,001	0,01	±30	•	•	•	•	•	•	•	•	•	•	•	•	•	
134210075	40-100	20	80	6,5	variable			0,03	±40	•	•	•	•	•	•	•	•	•	•	•	•	•	•

Folders / 2000 val  
Long range / HID  
USB HID / Update

- Industry 4.0 adopted Internal caliper gauge with computerized MICS system with 1,54" color Touchscreen
- MODIFICATIONS of contacts: CONE (R0.3/R0.5), POINT (R0.5), BALL (Ø1, Ø1.5, Ø2)
- Functions: Go/NoGo, Max/Min, Formula, Timer, Linear correction, Temperature correction, Resolution selecting, Connection status
- Memory manager: 2000 values, Folders system, Statistics mode, Memory data transfer
- 4 MODES DATA TRANSFER: WIRELESS to MDS app (Windows, Android, iOS, MacOS); WIRELESS HID, WIRELESS HID+MAC, USB HID
- Calibration certificate included (ISO17025 (Ilac MRA))



Item No	Range	Span	Depth	Groove depth	Measur contact	Contact points	Resolution	Repeatability	Accuracy	Preset	Go/NoGo	Max/Min	Formula	Timer	Temp comp	Linear corr	Calibr date	FW update	Recharge	Memory	WIRELESS	USB	
	mm	mm	mm	mm	mm	mm	mm	mm	µm														
<b>INTERNAL COMPUTERIZED CALIPER GAUGE CONE contact (Form A)</b>																							
134102505	5-25	20	35	1	1,5	Cone R 0,3	0,001	0,005	±15	•	•	•	•	•	•	•	•	•	•	•	•	•	
134104005	20-40	20	80	3	6,5	Cone R 0,5		0,005	±15	•	•	•	•	•	•	•	•	•	•	•	•	•	
134106005	40-60	20	80	3	8,5	Cone R 0,5		0,005	±15	•	•	•	•	•	•	•	•	•	•	•	•	•	
<b>INTERNAL COMPUTERIZED CALIPER GAUGE POINT contact (Form B)</b>																							
134105025	30-50	20	80	3,5	12	Point R 0,5	0,001	0,01	±20	•	•	•	•	•	•	•	•	•	•	•	•	•	
134107025	50-70	20	80	3,5	12			0,01	±20	•	•	•	•	•	•	•	•	•	•	•	•	•	•
134109025	70-90	20	80	3,5	22			0,01	±25	•	•	•	•	•	•	•	•	•	•	•	•	•	•
<b>INTERNAL COMPUTERIZED CALIPER GAUGE BALL contact (Form D)</b>																							
134104545	25-45	20	80	3,5	15	Ball Ø 1	0,001	0,005	±20	•	•	•	•	•	•	•	•	•	•	•	•	•	
134106545	45-65	20	80	3,5	15			0,005	±20	•	•	•	•	•	•	•	•	•	•	•	•	•	•
134108545	65-85	20	80	3,5	25			0,01	±25	•	•	•	•	•	•	•	•	•	•	•	•	•	•
134110045	50-100	50	180	3,5	15	Ball Ø 2		0,02	±40	•	•	•	•	•	•	•	•	•	•	•	•	•	•
134115045	100-150	50	180	3,5	15			0,02	±50	•	•	•	•	•	•	•	•	•	•	•	•	•	•
134120045	150-200	50	180	3,5	15			0,03	±50	•	•	•	•	•	•	•	•	•	•	•	•	•	•
<b>INTERNAL COMPUTERIZED CALIPER GAUGE INTERCHANGEABLE BALL contact (Form D)</b>																							
134110575	45-105	20	80	3,5	variable	Ball Ø 1	0,001	0,01	±30	•	•	•	•	•	•	•	•	•	•	•	•	•	
134120075	100-220	50	180	3,5	variable	Ball Ø 2		0,03	±60	•	•	•	•	•	•	•	•	•	•	•	•	•	•

- **Industry 4.0** adopted sub-micron 3-point internal micrometer with computerized MICS system with 1,54" color Touchscreen
- **Functions:** Go/NoGo, Max/Min, Formula, Timer, Linear correction, Temperature correction, Resolution selecting, Connection status
- **Memory manager:** 2000 values, Folders system, Statistics mode, Memory data transfer
- **4 MODES DATA TRANSFER:** WIRELESS to MDS app (Windows, Android, iOS, MacOS); WIRELESS HID, WIRELESS HID+MAC, USB HID
- **Calibration** certificate included (ISO17025 (Ilac MRA))

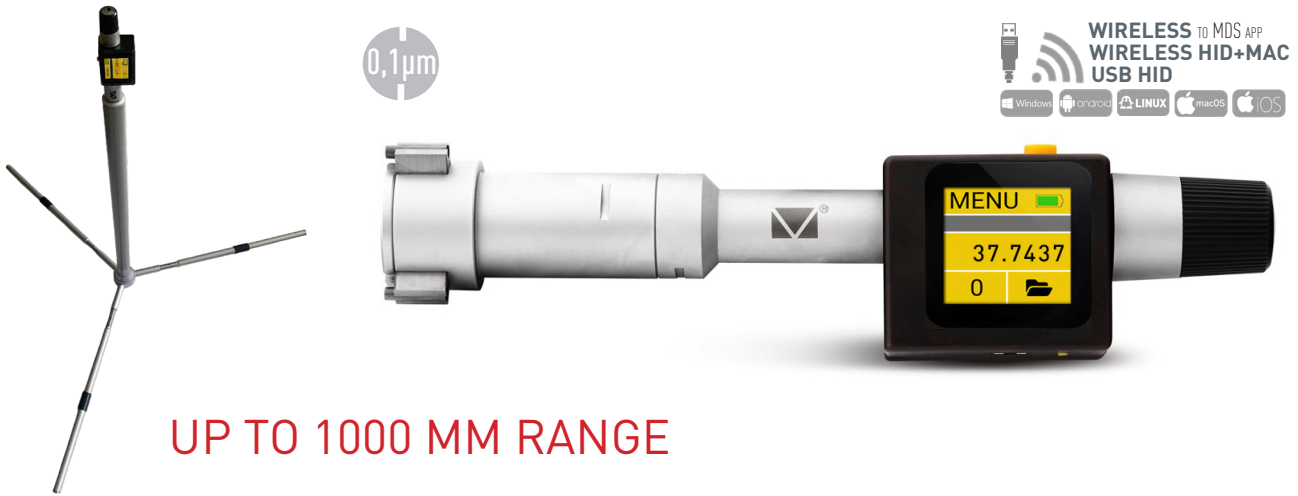

**UP TO 1000 MM RANGE**

Item No	Range		Reso- lution	Accur.	Max depth	Setting ring	Preset	Go/NoGo	Max/Min	Formula	Timer	Temp comp	Linear corr	Calibr date	Recharge	Memory	WIRELESS	USB
	mm	inch																
133700210	2-2,5	0.08-0.09"	0,0001	±3	12.5	•	•	•	•	•	•	•	•	•	•	Folders / 2000 val	Long range / HID	USB HID / Update
133700310	2,5-3	0.09-0.12"		±3	12.5	•	•	•	•	•	•	•	•	•	•			
133700410	3-4	0.12-0.16"		±3	22.5	•	•	•	•	•	•	•	•	•	•			
133700510	4-5	0.16-0.20"		±3	22.5	•	•	•	•	•	•	•	•	•	•			
133700610	5-6	0.20-0.24"		±4	22.5	•	•	•	•	•	•	•	•	•	•			
133700810	6-8	0.24-0.32"		±4	154	•	•	•	•	•	•	•	•	•	•			
133701010	8-10	0.32-0.4"		±4	154	•	•	•	•	•	•	•	•	•	•			
133701210	10-12	0.4-0.5"		±4	154	•	•	•	•	•	•	•	•	•	•			
133701610	12-16	0.5-0.63"		±4	230	•	•	•	•	•	•	•	•	•	•			
133702010	16-20	0.63-0.8"		±4	230	•	•	•	•	•	•	•	•	•	•			
133702510	20-25	0.8-1"		±4	240	•	•	•	•	•	•	•	•	•	•			
133703010	25-30	1-1.2"		±4	240	•	•	•	•	•	•	•	•	•	•			
133704010	30-40	1.2-1.6"		±4	240	•	•	•	•	•	•	•	•	•	•			
133705010	40-50	1.6-2"		±4	240	•	•	•	•	•	•	•	•	•	•			
133707010	50-70	2-3"		±4	250	•	•	•	•	•	•	•	•	•	•			
133710010	70-100	3-4"		±4	250	•	•	•	•	•	•	•	•	•	•			
133715010	100-150	4-6"		±4	250	•	•	•	•	•	•	•	•	•	•			
133725010	150-250	6-10"		±5	250	•	•	•	•	•	•	•	•	•	•			
133730010	200-300	8-12"		±6	250	•	•	•	•	•	•	•	•	•	•			
133750010	200-500	8-20"		±8	650	option	•	•	•	•	•	•	•	•	•			
133790011	200-1000	8-40"	±10	1150	•	•	•	•	•	•	•	•	•	•				

**DOWNLOAD APP**



Item No	Range	Measuring heads	Setting rings	Max depth mm
	mm			
133700203	2-3	2 pcs	1pcs	12,5
133370306	3-6	3 pcs	3pcs	22,5
133370612	6-12	3 pcs	3pcs	50+100
133371220	12-20	2pcs	1pcs	80+150
133372050	20-50	4pcs	2pcs	90+150
133375090	50-100	2pcs	1pcs	107+150
133579125	100-250	2pcs	1pcs	107+150

**COMPUTERIZED 3 POINT INTERNAL MICROMETER SET**

**OPTIONAL ACCESSORIES**

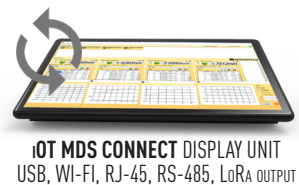



# LONG COMPUTERIZED 3 POINT INTERNAL MICROMETER

- Industry 4.0 adopted Long range (up to 3m) 3-point internal micrometer with computerized MICS system
- Functions: Go/NoGo, Max/Min, Formula, Timer, Linear correction, Temperature correction, Resolution selecting, Connection status
- Memory manager: 2000 values, Folders system, Statistics mode, Memory data transfer
- **4 MODES DATA TRANSFER:** WIRELESS to MDS app (Windows, Android, iOS, MacOS); WIRELESS HID, WIRELESS HID+MAC, USB HID
- Calibration certificate included (ISO17025 (Ilac MRA))

0,1 μm

UP TO 3M DEPTH



Item No	Range		Reso- lution	Accur.	Max depth	Setting ring	Preset	Go/NoGo	Max/Min	Formula	Timer	Temp comp	Linear corr	Calibr date	Recharge	Memory	WIRELESS	USB
	mm	inch																
133702511	20-25	0.8-1"	0,0001	±4	1000	•	•	•	•	•	•	•	•	•	•	Folders / 2000 val	Long range / HID	USB HID / Update
133702512				±6	2000	•	•	•	•	•	•	•	•	•	•			
133703011	25-30	1-1.2"		±4	1000	•	•	•	•	•	•	•	•	•	•			
133703012				±6	2000	•	•	•	•	•	•	•	•	•	•			
133704011	30-40	1.2-1.6"		±4	1000	•	•	•	•	•	•	•	•	•	•			
133704012				±6	2000	•	•	•	•	•	•	•	•	•	•			
133705011	40-50	1.6-2"		±4	1000	•	•	•	•	•	•	•	•	•	•			
133705012				±6	2000	•	•	•	•	•	•	•	•	•	•			
133707011	50-70	2-3"		±4	1000	•	•	•	•	•	•	•	•	•	•			
133707012				±6	2000	•	•	•	•	•	•	•	•	•	•			
133707013				±8	3000	•	•	•	•	•	•	•	•	•	•			
133710011	70-100	3-4"		±4	1000	•	•	•	•	•	•	•	•	•	•			
133710012				±6	2000	•	•	•	•	•	•	•	•	•	•			
133710013				±8	3000	•	•	•	•	•	•	•	•	•	•			
133715011	100-150	4-6"		±4	1000	•	•	•	•	•	•	•	•	•	•			
133715012				±6	2000	•	•	•	•	•	•	•	•	•	•			
133715013				±8	3000	•	•	•	•	•	•	•	•	•	•			
133725011	150-250	6-10"		±5	1000	•	•	•	•	•	•	•	•	•	•			
133725012				±7	2000	•	•	•	•	•	•	•	•	•	•			
133725013				±9	3000	•	•	•	•	•	•	•	•	•	•			
133730011	200-300	8-12"	±6	1000	option	•	•	•	•	•	•	•	•	•				
133730012			±8	2000		•	•	•	•	•	•	•	•	•				
133730013			±9	3000		•	•	•	•	•	•	•	•	•				
133790012	200-1000	8-40"	±11	2000	•	•	•	•	•	•	•	•	•	•				
133790013			±14	3000	•	•	•	•	•	•	•	•	•	•				



DOWNLOAD APP



# LONG COMPUTERIZED 3 POINT INTERNAL MICROMETER SET

Item No	Range	Measuring heads	Setting rings	Max depth
	mm			mm
133372051	20-50	4pcs	2pcs	1000
133372052				2000
133375091	50-100	2pcs	1pcs	1000
133375092				2000
133375093				3000
133579126	100-250	2pcs	1pcs	1000
133579127				2000
133579128				3000



- Micron Pistol grip bore gauge
- PRESET, mm/inch, HOLD function
- USB data transfer
- CR2032 3V battery
- **Calibration** certificate included (ISO17025 (Ilac MRA))



Item No	Range		Resol.	Accur.	Setting rings	Max depth	Preset	USB
	mm	inch						
133500800	6-8	0.25-0.32"	0,001	±4	•	50+100	•	USB HID
133501000	8-10	0.32-0.4"		±4	•	50+100	•	
133501200	10-12	0.4-0.5"		±4	•	50+100	•	
133501600	12-16	0.5-0.63"		±4	•	65+150	•	
133502000	16-20	0.63-0.8"		±4	•	65+150	•	
133502500	20-25	0.8"-1"		±4	•	91+150	•	
135303000	25-30	1-1.2"		±4	•	91+150	•	
133504000	30-40	1.2-1.6"		±4	•	97+150	•	
133505000	40-50	1.6-2"		±5	•	97+150	•	
133506300	50-63	2-2.5"		±5	•	112+150	•	
133507500	62-75	2.5-3"		±5	•	112+150	•	
133508800	75-88	3-3.5"		±5	•	112+150	•	
133510000	87-100	3.5-4"		±5	•	112+150	•	
133512500	100-125	4-5"		±5	•	130+150	•	
133515000	125-150	5-6"		±5	option	130+150	•	

**OPTIONAL ACCESSORIES**



**120125000** USB HID DATA TRANSFER CABLE  
DIRECT DATA TRANSFER, LIKE A KEYBOARD

**DIGITAL** PISTOL GRIP BORE GAUGE **SET'S**

Item No	Range		Measuring heads	Setting rings	Max depth
	mm	inch			
133570613	6-12	0.25-0.5"	3pcs	3pcs	50+100
133571221	12-20	0.5-0.8"	2pcs	1pcs	65+150
133572051	20-50	0.8-2"	4pcs	2pcs	91+150
133575091	50-100	2-4"	4pcs	2pcs	65+150
133579131	6-150	0.25-6"	15pcs	up to 100mm	

# COMPUTERIZED PISTOL GRIP BORE GAUGE

- Industry 4.0 adopted sub-micron Pistol grip bore gauge with computerized MICS system with 1,54" color Touchscreen
- Functions: Go/NoGo, Max/Min, Formula, Timer, Linear correction, Temperature correction, Resolution selecting, Connection status
- Memory manager: 2000 values, Folders system, Statistics mode, Memory data transfer
- **4 MODES DATA TRANSFER:** WIRELESS to MDS app (Windows, Android, iOS, MacOS); WIRELESS HID, WIRELESS HID+MAC, USB HID
- Calibration certificate included (ISO17025 (Ilac MRA))



Item No	Range		Resol.	Accur.	Setting rings	Max depth	Preset	Go/NoGo	Max/Min	Formula	Timer	Temp comp	Linear corr	Calibr date	Recharge	Memory	WIRELESS	USB	
	mm	inch																	mm
133500810	6-8	0.25-0.32"	0,0001	±3	•	50+100	•	•	•	•	•	•	•	•	•	Folders / 2000 val	Long range / HID	USB HID / Update	
133501010	8-10	0.32-0.4"		±3	•	50+100	•	•	•	•	•	•	•	•	•				•
133501210	10-12	0.4-0.5"		±3	•	50+100	•	•	•	•	•	•	•	•	•				•
133501610	12-16	0.5-0.63"		±3	•	65+150	•	•	•	•	•	•	•	•	•				•
133502010	16-20	0.63-0.8"		±3	•	65+150	•	•	•	•	•	•	•	•	•				•
133502510	20-25	0.8"-1"		±3	•	91+150	•	•	•	•	•	•	•	•	•				•
135303010	25-30	1-1.2"		±3	•	91+150	•	•	•	•	•	•	•	•	•				•
133504010	30-40	1.2-1.6"		±3	•	97+150	•	•	•	•	•	•	•	•	•				•
133505010	40-50	1.6-2"		±4	•	97+150	•	•	•	•	•	•	•	•	•				•
133506310	50-63	2-2.5"		±4	•	112+150	•	•	•	•	•	•	•	•	•				•
133507510	62-75	2.5-3"		±4	•	112+150	•	•	•	•	•	•	•	•	•				•
133508810	75-88	3-3.5"		±4	•	112+150	•	•	•	•	•	•	•	•	•				•
133510010	87-100	3.5-4"		±4	•	112+150	•	•	•	•	•	•	•	•	•				•
133512510	100-125	4-5"		±4	•	130+150	•	•	•	•	•	•	•	•	•				•
133515010	125-150	5-6"		±4	option	130+150	•	•	•	•	•	•	•	•	•				•

DOWNLOAD APP



## COMPUTERIZED PISTOL GRIP BORE GAUGE SET's

Item No	Range		Measuring heads	Setting rings	Max depth
	mm	inch			
133570612	6-12	0.25-0.5"	3pcs	3pcs	50+100
133571220	12-20	0.5-0.8"	2pcs	1pcs	65+150
133572050	20-50	0.8-2"	4pcs	2pcs	91+150
133575090	50-100	2-4"	4pcs	2pcs	65+150
133579130	6-150	0.25-6"	15pcs	up to 100mm	
LONG PISTOL GRIP BORE GAUGE SET					
133572051	20-50	0.8-2"	4pcs	2pcs	1000
133573053	30-50	1.2-2"	4pcs	2pcs	3000
133575091			4pcs	2pcs	1000
133575093	50-100	2-4"	4pcs	2pcs	3000
133575095			4pcs	2pcs	5000
133579131	20-150	0.8-4"	10pcs	5pcs	1000
133579133			8pcs		3000
133579135	30-150	1.2-4"	8pcs	4pcs	5000

### OPTIONAL ACCESSORIES

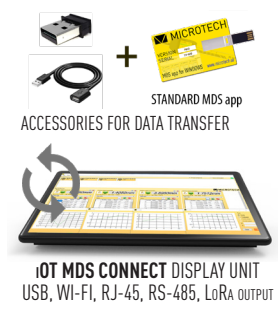

- **Industry 4.0** adopted Extra long Pistol grip bore gauge with computerized MICS system with 1,54" color Touchscreen
- Depth up to 5000mm
- **Functions:** Go/NoGo, Max/Min, Formula, Timer, Linear correction, Temperature correction, Resolution selecting, Connection status
- **Memory manager:** 2000 values, Folders system, Statistics mode, Memory data transfer
- **4 MODES DATA TRANSFER:** WIRELESS to MDS app (Windows, Android, iOS, MacOS); WIRELESS HID, WIRELESS HID+MAC, USB HID
- **Calibration** certificate included (ISO17025 (Ilac MRA))



0,1µm

Item No	Range		Resol.	Accur.	Setting rings	Max depth	Preset	Go/NoGo	Max/Min	Formula	Timer	Temp comp	Linear corr	Calibr date	Recharge	Memory	WIRELESS	USB					
	mm	inch																	mm	µm	mm		
133502511	20-25	0.8"-1"	0,0001	±3	•	1000	•	•	•	•	•	•	•	•	•	Folders / 2000 val	Long range / HID	USB HID / Update					
135303011	25-30	1-1.2"		±3	•	1000	•	•	•	•	•	•	•	•	•								
135303012				±4	•	2000	•	•	•	•	•	•	•	•	•								
133504011	30-40	1.2-1.6"		±3	•	1000	•	•	•	•	•	•	•	•	•								
133504012				±4	•	2000	•	•	•	•	•	•	•	•	•								
133504013				±5	•	3000	•	•	•	•	•	•	•	•	•				•				
133505011	40-50	1.6-2"		±4	•	1000	•	•	•	•	•	•	•	•	•								
133505012				±5	•	2000	•	•	•	•	•	•	•	•	•								
133505013				±5	•	3000	•	•	•	•	•	•	•	•	•				•				
133505015				±7	•	5000	•	•	•	•	•	•	•	•	•				•				
133506311				50-63	2-2.5"	±4	•	1000	•	•	•	•	•	•	•				•	•			
133506312	±5	•				2000	•	•	•	•	•	•	•	•	•								
133506313	±5	•				3000	•	•	•	•	•	•	•	•	•				•				
133506315	±7	•				5000	•	•	•	•	•	•	•	•	•				•				
133507511	62-75	2.5-3"		±4	•	1000	•	•	•	•	•	•	•	•	•								
133507512				±5	•	2000	•	•	•	•	•	•	•	•	•				•				
133507513				±5	•	3000	•	•	•	•	•	•	•	•	•				•				
133507515				±7	•	5000	•	•	•	•	•	•	•	•	•				•				
133508811	75-88	3-3.5"		±4	•	1000	•	•	•	•	•	•	•	•	•								
133508812				±5	•	2000	•	•	•	•	•	•	•	•	•				•				
133508813				±5	•	3000	•	•	•	•	•	•	•	•	•				•				
133508815				±7	•	5000	•	•	•	•	•	•	•	•	•				•				
133510011	87-100	3.5-4"		±4	•	1000	•	•	•	•	•	•	•	•	•								
133510012				±5	•	2000	•	•	•	•	•	•	•	•	•				•				
133510013				±5	•	3000	•	•	•	•	•	•	•	•	•				•				
133510015				±7	•	5000	•	•	•	•	•	•	•	•	•				•				
133512511				100-125	4-5"	±4	option	1000	•	•	•	•	•	•	•				•	•	•	Folders / 2000 val	Long range / HID
133512512	±5	2000				•		•	•	•	•	•	•	•	•				•	•			
133512513	±5	3000				•		•	•	•	•	•	•	•	•				•	•			
133512515	±7	5000				•		•	•	•	•	•	•	•	•				•	•			
133515011	125-150	5-6"	±4	option	1000	•	•	•	•	•	•	•	•	•	•	Folders / 2000 val	Long range / HID	USB HID / Update					
133515012			±5		2000	•	•	•	•	•	•	•	•	•	•				•				
133515013			±5		3000	•	•	•	•	•	•	•	•	•	•				•				
133515015			±7		5000	•	•	•	•	•	•	•	•	•	•				•				

DOWNLOAD APP



# BIG BARELL PISTOL GRIP BORE GAUGES

- Three-point Big barrel Pistol-grip bore gauges
- Carbide tipped measuring pins
- Computerized **MICS** indication system
- **4 MODES DATA TRANSFER:** WIRELESS to MDS app (Windows, Android, iOS, MacOS); WIRELESS HID, WIRELESS HID+MAC, USB HID
- Calibration certificate included (ISO17025 (Ilac MRA))

LUNETS SET



MEASURING HUB  
MICROTECH DEVICES CONNECT



WIRELESS TO MDS APP  
WIRELESS HID+MAC  
USB HID



Item No	Range		Reso- lution	Max Depth	Lunet set	Preset	Go/NoGo	Max/Min	Formula	Timer	Temp comp	Linear corr	Calibr date	Recharge	Memory	WIRELESS	USB
	Caliber	mm															
138206017	60	59-61	0,0001	1000	option	•	•	•	•	•	•	•	•	•	•	Folders / 2000 val Long range / HID USB HID	
138206217	62	61-63		1000		•	•	•	•	•	•	•	•	•	•		
138208017	80	79-81		1500	•	•	•	•	•	•	•	•	•	•			
138208217	82	81-83		1500	1	•	•	•	•	•	•	•	•	•			
138212027	120	119-121		2000	2	•	•	•	•	•	•	•	•	•			

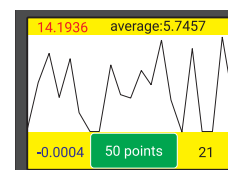

ON-LINE  
GRAPHIC MODE

# GUN BARELL PISTOL GRIP BORE GAUGES

- Three-point Gun barrel Pistol-grip bore gauges
- Carbide tipped measuring pins
- Computerized **MICS** indication system
- **4 MODES DATA TRANSFER:** WIRELESS to MDS app (Windows, Android, iOS, MacOS); WIRELESS HID, WIRELESS HID+MAC, USB HID
- Calibration certificate included (ISO17025 (Ilac MRA))

MEASURING HUB  
MICROTECH DEVICES CONNECT



WIRELESS TO MDS APP  
WIRELESS HID+MAC  
USB HID

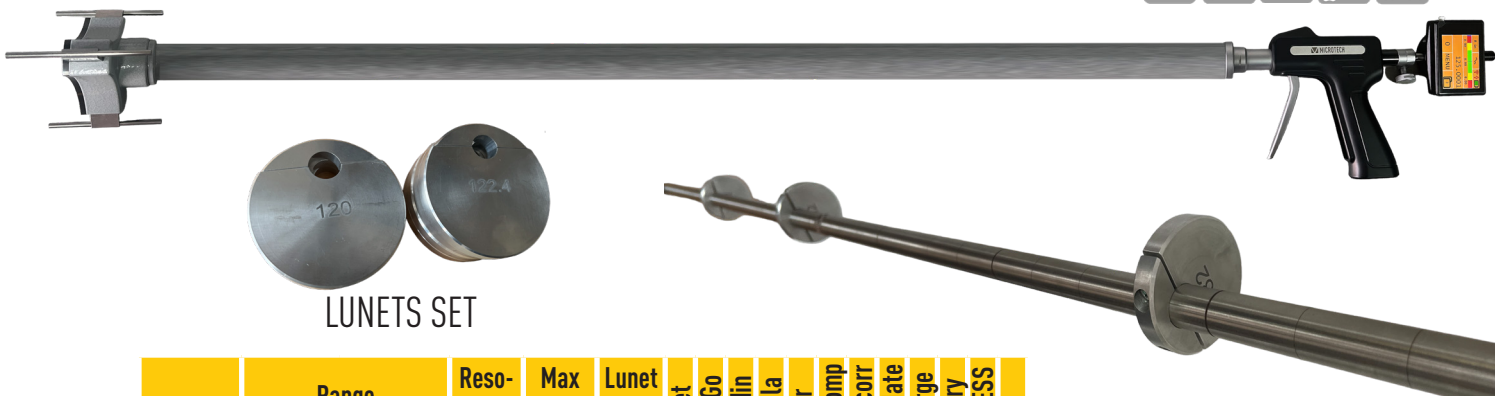

LUNETS SET

Item No	Range		Reso- lution	Max Depth	Lunet set	Preset	Go/NoGo	Max/Min	Formula	Timer	Temp comp	Linear corr	Calibr date	Recharge	Memory	WIRELESS	USB
	Caliber	mm															
138112027	120	118.5-121.5	0,0001	2000	1	•	•	•	•	•	•	•	•	•	Folders / 2000 val Long range / HID USB HID		
138112237	122	120.5-123.5		3000	2	•	•	•	•	•	•	•	•	•			
138112437	124	122.5-125.5		3000	2	•	•	•	•	•	•	•	•	•			
138112537	125	123.5-126.5		3000	2	•	•	•	•	•	•	•	•	•			
138112567				6000	4	•	•	•	•	•	•	•	•	•			
138115237	152	150.5-153.5		3000	2	•	•	•	•	•	•	•	•	•			
138115267				6000	4	•	•	•	•	•	•	•	•	•			
138115537	155	153.5-156.5		3000	2	•	•	•	•	•	•	•	•	•			
138115567				6000	4	•	•	•	•	•	•	•	•	•			

- Tubular Inside micrometers with range up to 6m
- Digital IP65 indication system
- Calibration certificate included (ISO17025 (Ilac MRA))



Item No	Range		Reso- lution	Accu- racy	Tube D	Extension rods	Proof	Preset	
	mm	inch							mm
133800102	125-1000	5-40"	0,001	±20	22	25, 50 (2pcs), 100, 200, 400	IP65	•	
133800152	125-1500	5-60"		±25		25, 50 (2pcs), 100 (2pcs), 200, 400 (2pcs)		•	
133800202	125-2100	5-84"		±30		25, 50 (2pcs), 100 (2pcs), 200 (2pcs), 400 (3pcs)		•	
133800302	125-3000	5-120"		±40		25, 50 (2pcs), 100 (2pcs), 200 (3pcs), 400 (5pcs)		•	
133800402	125-4000	5-160"		±50		25, 50 (2pcs), 100 (2pcs), 200 (2pcs), 400 (8pcs)		•	
133800502	125-5000	5-200"		±70		33		25, 50 (2pcs), 100 (2pcs), 200 (3pcs), 400 (10pcs)	•
133800602	125-6000	5-240"		±80				25, 50 (2pcs), 100 (2pcs), 200 (4pcs), 400 (12pcs)	•

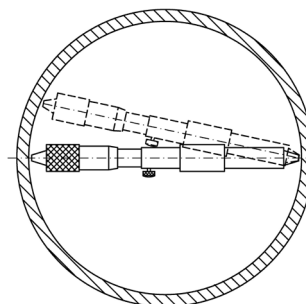

- Tubular Inside micrometers with range up to 6m
- Computerized **MICS** indication system Modification with **Long range** Wireless, Wireless HID or USB HID data transfer to Windows, Android, iOS, macOS, Linux systems direct to any app.
- **Calibration** certificate included (ISO17025 (Ilac MRA))

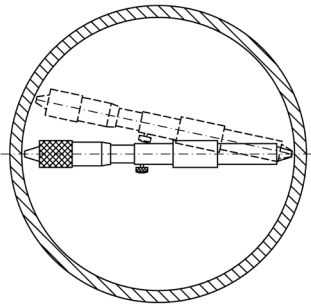

Item No	Range		Reso- lution	Accu- racy	Tube D	Extension rods	Proof	Preset	Go/NoGo	Max/Min	Formula	Timer	Temp comp	Linear corr	Calibr date	Recharge	Memory	WIRELESS	USB	
	mm	inch																		mm
133800100	125-1000	5-40"	0,0001	±15	22	25, 50 (2pcs), 100 (2pcs), 200 (3pcs), 400 (10pcs)	IP65	•	•	•	•	•	•	•	•	•	Folders / 2000 val	Long range / HID	USB HID / Update	
133800150	125-1500	5-60"		±15		25, 50 (2pcs), 100 (2pcs), 200 (4pcs), 400 (12pcs)		•	•	•	•	•	•	•	•	•				
133800200	125-2100	5-84"		±20		25, 50 (2pcs), 100 (2pcs), 200 (2pcs), 400 (3pcs)		•	•	•	•	•	•	•	•	•				
133800300	125-3000	5-120"		±30		25, 50 (2pcs), 100 (2pcs), 200 (3pcs), 400 (5pcs)		•	•	•	•	•	•	•	•	•				
133800400	125-4000	5-160"		±40		25, 50 (2pcs), 100 (2pcs), 200 (2pcs), 400 (8pcs)		•	•	•	•	•	•	•	•	•				
133800500	125-5000	5-200"		±50		33		25, 50 (2pcs), 100 (2pcs), 200 (3pcs), 400 (10pcs)	•	•	•	•	•	•	•	•				•
133800600	125-6000	5-240"		±60				25, 50 (2pcs), 100 (2pcs), 200 (4pcs), 400 (12pcs)	•	•	•	•	•	•	•	•				•

### OPTIONAL ACCESSORIES



**IoT MDS CONNECT DISPLAY UNIT**  
USB, WI-FI, RJ-45, RS-485, LoRA OUTPUT



**IoT DATA BUTTON**

### DOWNLOAD APP



- Dial bore gauges with Carbide contacts with depth up to 2m
- Micron Digital indicator IP65 proof with PRESET function
- Custom range and depth for request
- **Calibration** certificate included (ISO17025 (Ilac MRA))



Item No	Range	Depth	Resolu- tion	Accuracy
	mm	mm	mm	µm
132010100	6-10	60	0.01	±8
132018100	10-18	110		±8
132050100	18-50	130		±12
132050111		500		±12
132050122		1000		±12
132050144		2000		±12
132160100	50-160	150		±15
132160111		500		±15
132160122		1000		±15
132160144		2000		±15
132250100	160-250	260		±15
132250122		1000		±15
132250144		2000		±15
132450100	250-450	260		±22
132450122		1000		±22
132450144		2000		±22
132900100	400-1000	440		±30
132900122		1000		±30
132900144		2000		±30
132951100	<b>130-1500</b>	440		±25
<b>BORE GAUGES SETS</b>				
132160105	<b>18-160</b>		0.01	±15
132450105	<b>18-450</b>			±22
132990105	<b>6-1000</b>			±30

UP TO  
**2000MM**  
DEPTH

**CUSTOM RANGE AND DEPTH FOR REQUEST**



# DIGITAL BORE GAUGES WITH CARBIDE CONTACTS

- Digital bore gauges with Carbide contacts with depth up to 2m
- Micron Digital indicator IP65 proof with PRESET function
- Custom range and depth for request
- **Calibration** certificate included (ISO17025 (Ilac MRA))



Item No	Range	Depth	Resolu- tion	Accuracy	Preset	Hold
	mm	mm		µm		
132010800	6-10	60	0.001	±3	•	•
132018800	10-18	110		±3	•	•
132050800	18-50	130		±3	•	•
132050811		500		±3	•	•
132050822		1000		±3	•	•
132050844		2000		±3	•	•
132160800	50-160	150		±3	•	•
132160811		500		±3	•	•
132160822		1000		±3	•	•
132160844		2000		±3	•	•
132250800	160-250	260		±5	•	•
132250822		1000		±5	•	•
132250844		2000		±5	•	•
132450800	250-450	260		±8	•	•
132450822		1000		±8	•	•
132450844		2000		±8	•	•
132900800	400-1000	440		±12	•	•
132900822		1000		±12	•	•
132900844		2000	±12	•	•	
132951800		130-1500	440	±8	•	•
<b>BORE GAUGES SETS</b>						
132160805	18-160		0.001	±3	•	•
132450805	18-450			±8	•	•
132990805	6-1000			±12	•	•

CUSTOM RANGE AND DEPTH FOR REQUEST

## OPTIONAL ACCESSORIES



120125000 USB HID DATA TRANSFER CABLE  
DIRECT DATA TRANSFER, LIKE A KEYBOARD



UNIVERSAL CALIBRATION STANDS

- Two-point dial bore gauges with range up to 1500mm and depth up to 2 m
- Carbide tipped measuring pins
- **4 MODES DATA TRANSFER:** WIRELESS to MDS app (Windows, Android, iOS, MacOS); WIRELESS HID, WIRELESS HID+MAC, USB HID
- Calibration certificate included (ISO17025 (Iac MRA))

WIRELESS TO MDS APP  
 WIRELESS HID+MAC  
 USB HID



**CUSTOM RANGE AND DEPTH FOR REQUEST**

Item No	Range	Depth	Resolu- tion	Accu- racy	Preset	Go/NoGo	Max/Min	Formula	Timer	Temp comp	Linear corr	Calibr date	FW update	Recharge	Memory	WIRELESS	USB
	mm	mm	mm	µm													
132010700	6-10	60	0.0001	±3	•	•	•	•	•	•	•	•	•	•	Folders / 2000 val	Long range / HID	USB HID / Update firmware
132018700	10-18	110		±3	•	•	•	•	•	•	•	•	•	•			
132050700	18-50	130		±3	•	•	•	•	•	•	•	•	•	•			
132050711		500		±3	•	•	•	•	•	•	•	•	•	•			
132050722		1000		±3	•	•	•	•	•	•	•	•	•	•			
132050744		2000		±3	•	•	•	•	•	•	•	•	•	•			
132160700	50-160	150		±3	•	•	•	•	•	•	•	•	•	•			
132160711		500		±3	•	•	•	•	•	•	•	•	•	•			
132160722		1000		±3	•	•	•	•	•	•	•	•	•	•			
132160744		2000		±3	•	•	•	•	•	•	•	•	•	•			
132250700	160-250	260		±5	•	•	•	•	•	•	•	•	•	•			
132250722		1000		±5	•	•	•	•	•	•	•	•	•	•			
132250744		2000		±5	•	•	•	•	•	•	•	•	•	•			
132450700		250-450		260	±8	•	•	•	•	•	•	•	•	•			
132450722	1000			±8	•	•	•	•	•	•	•	•	•	•			
132450744	2000			±8	•	•	•	•	•	•	•	•	•	•			
132900700	400-1000			440	±12	•	•	•	•	•	•	•	•	•			
132900722		1000		±12	•	•	•	•	•	•	•	•	•	•			
132900744		2000		±12	•	•	•	•	•	•	•	•	•	•			
132951700		130-1500		440	±8	•	•	•	•	•	•	•	•	•			
BORE GAUGES SETS																	
132160705	18-160		0.0001	±3	•	•	•	•	•	•	•	•	•	•	•	•	•
132450705	18-450		0.0001	±8	•	•	•	•	•	•	•	•	•	•	•	•	•
132990705	6-1000		0.0001	±12	•	•	•	•	•	•	•	•	•	•	•	•	•

**OPTIONAL ACCESSORIES**

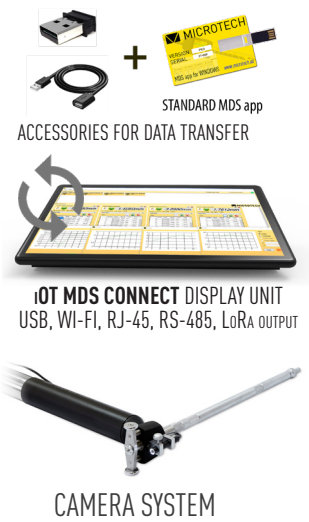

STANDARD MDS app  
 ACCESSORIES FOR DATA TRANSFER

**IOT MDS CONNECT DISPLAY UNIT**  
 USB, WI-FI, RJ-45, RS-485, LoRA OUTPUT

CAMERA SYSTEM

**DOWNLOAD APP**



- Two-point Big depth bore gauges with Carbide contacts. Depth up to 10m with modular construction for easy transportation
- Patents UA103980, UA114974, UA149184
- Optional retractable head and support set
- **4 MODES DATA TRANSFER:** WIRELESS to MDS app (Windows, Android, iOS, MacOS); WIRELESS HID, WIRELESS HID+MAC, USB HID
- Calibration certificate included (ISO17025 (Ilac MRA))



MODULAR CONSTRUCTION



MODIFICATION WITH SUPPORT SET AND RETRACTABLE HEAD

## CUSTOM RANGE AND DEPTH FOR REQUEST

Item No	Range	Reso- lution	Depth	Modules		Accuracy (Horizontal)	Supports set with rolls	Retractable head	Preset	Go/NoGo	Max/Min	Formula	Timer	Temp comp	Linear corr	Calibr date	FW update	Recharge	Memory	WIRELESS	USB	CAMERA	
				length	qty																		
	mm	mm	mm	mm	pcs	µm																	
131050745	35-50	0,0001	3000	1500	2	±12			•	•	•	•	•	•	•	•	•	•					
131160745	50-160		3000	1500	2	±10			•	•	•	•	•	•	•	•	•	•					
131160755	85-160		5000	1700	3	±12	option	option	•	•	•	•	•	•	•	•	•	•					
131250745	160-250		3000	1500	2	±12			•	•	•	•	•	•	•	•	•	•	•				
131250755			5000	1700	3	±15			•	•	•	•	•	•	•	•	•	•	•				
131260750	105-260			1700	3	±28		•	•	•	•	•	•	•	•	•	•	•	•				
131260770			7000	1750	4	±31		•	•	•	•	•	•	•	•	•	•	•	•				
131260795			10000	2000	5	±35		•	•	•	•	•	•	•	•	•	•	•	•				
131450745	250-450			3000	1500	2	±17	option	option	•	•	•	•	•	•	•	•	•	•				
131450755			5000	1700	3	±20	option	option	•	•	•	•	•	•	•	•	•	•	•				
131450750				5000	1700	3	±30	•	•	•	•	•	•	•	•	•	•	•	•				
131450770			7000	1750	4	±33	•	•	•	•	•	•	•	•	•	•	•	•	•				
131450795			10000	2000	5	±37	•	•	•	•	•	•	•	•	•	•	•	•	•				
131900745			400-1000		3000	1500	2	±25			•	•	•	•	•	•	•	•	•	•			
131900755	5000			1700	3	±30	option	option	•	•	•	•	•	•	•	•	•	•	•				
131990750				5000	1700	3	±35	•	•	•	•	•	•	•	•	•	•	•	•				
131990770	7000			1750	4	±40	•	•	•	•	•	•	•	•	•	•	•	•	•				
131990795	10000			2000	5	±45	•	•	•	•	•	•	•	•	•	•	•	•	•				

## OPTIONAL ACCESSORIES



STANDARD MDS app

ACCESSORIES FOR DATA TRANSFER



CAMERA SYSTEM



RETRACTABLE HEAD



SUPPORTS WITH ROLLS

DOWNLOAD APP



MADE IN UKRAINE

- Retractable construction of measuring part for block bores, grooves and recesses
- For the determination of internal diameters, where a smaller bore lying in front of this diameter, has to be passed
- Patents UA147920, UA150454, UA99686
- Digital or Computerized **MICS** indication system Modification with **4 MODES DATA TRANSFER**: WIRELESS to MDS app (Windows, Android, iOS, MacOS); WIRELESS HID, WIRELESS HID+MAC, USB HID
- Calibration certificate included (ISO17025 (Ilac MRA))

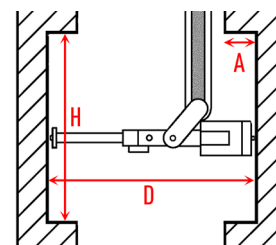
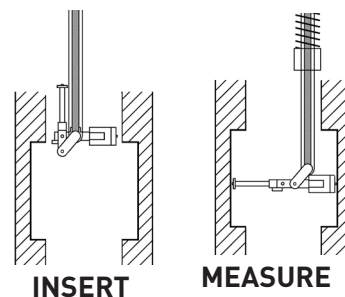

**CUSTOM RANGE AND DEPTH FOR REQUEST**

Item No*	Range D	Reso- lution	Max A	Min H	MaxH	Accuracy
	mm	mm	mm	mm	mm	µm
139160800	70-160	0,001	20	D-30	150	±15
139160811					1000	±25
139160822					2000	±30
139160833					3000	±35
139250800					150	±15
139250811	160-250				1000	±25
139250822					2000	±30
139250833					3000	±35
139450800					150	±15
139450811					250-450	1000
139450822	2000	±30				
139450833	3000	±35				
139550800	250-550	60	100+0,3*D	380		±25
139780800	480-780	400	±30			
139910800	720-1020	400	±35			

**OPTIONAL ACCESSORIES**



**120125000** USB HID DATA TRANSFER CABLE  
DIRECT DATA TRANSFER, LIKE A KEYBOARD

- Retractable construction of measuring part for block bores, grooves and recesses
- For the determination of internal diameters, where a smaller bore lying in front of this diameter, has to be passed
- Patents UA147920, UA150454, UA99686
- Computerized **MICS** indication system
- **4 MODES DATA TRANSFER:** WIRELESS to MDS app (Windows, Android, iOS, MacOS); WIRELESS HID, WIRELESS HID+MAC, USB HID
- Calibration certificate included (ISO17025 (Ilac MRA))



WIRELESS TO MDS APP  
WIRELESS HID+MAC  
USB HID

Windows Android LINUX macOS iOS

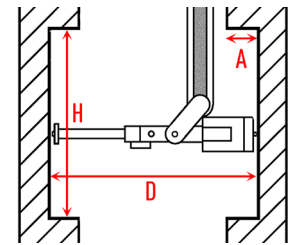
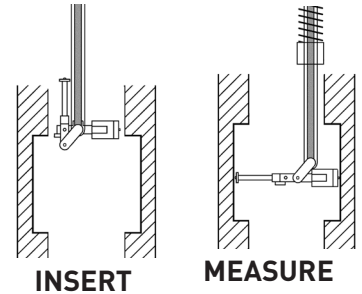

CUSTOM RANGE AND DEPTH FOR REQUEST

Item No*	Range D	Reso- lution	Max A	Min H	MaxH	COMPUTERIZED																			
						Accur.	Preset	Go/NoGo	Max/Min	Formula	Timer	Temp comp	Linear corr	Calibr date	FW update	Recharge	Memory	WIRELESS	USB						
	mm	mm	mm	mm	mm	μm																			
139160700	70-160	0,0001	20	D-30	150	±12	•	•	•	•	•	•	•	•	•	•	•	Folders / 2000 val	Long range / HID	USB HID / Update firmware					
139160711					1000	±20	•	•	•	•	•	•	•	•	•	•	•				•				
139160722					2000	±25	•	•	•	•	•	•	•	•	•	•	•				•				
139160733					3000	±30	•	•	•	•	•	•	•	•	•	•	•				•				
139250700	160-250				150	±12	•	•	•	•	•	•	•	•	•	•	•				•	•			
139250711					1000	±20	•	•	•	•	•	•	•	•	•	•	•				•				
139250722					2000	±25	•	•	•	•	•	•	•	•	•	•	•				•				
139250733					3000	±30	•	•	•	•	•	•	•	•	•	•	•				•				
139450700	250-450				150	±12	•	•	•	•	•	•	•	•	•	•	•				•	•	•	•	•
139450711					1000	±20	•	•	•	•	•	•	•	•	•	•	•				•	•	•	•	
139450722					2000	±25	•	•	•	•	•	•	•	•	•	•	•				•	•	•	•	
139450733					3000	±30	•	•	•	•	•	•	•	•	•	•	•				•	•	•	•	
139550700	250-550			60	100+0,3*D	380	±20	•	•	•	•	•	•	•	•	•	•	•	•	•					
139780700	480-780			400		±25	•	•	•	•	•	•	•	•	•	•	•	•	•	•					
139910700	720-1020			400		±30	•	•	•	•	•	•	•	•	•	•	•	•	•	•					

## OPTIONAL ACCESSORIES

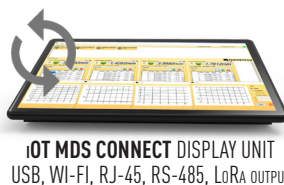

DOWNLOAD APP



- Two-point Shotgun bore gauges for different calibers with depth 760mm
- Carbide tipped measuring pins
- Computerized **MICS** indication system
- **4 MODES DATA TRANSFER:** WIRELESS to MDS app (Windows, Android, iOS, MacOS); WIRELESS HID, WIRELESS HID+MAC, USB HID
- Calibration certificate included (ISO17025 (Ilac MRA))

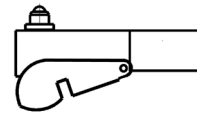

Item No	Range			Reso- lution	Max Depth	Accu- racy	Preset	Go/NoGo	Max/Min	Formula	Timer	Temp comp	Linear corr	Calibr date	Recharge	Memory	WIRELESS	USB	
	Caliber	mm	inch																mm
138070007	0.410	10.2-10,6	0,410"	0,0001	760	±12	•	•	•	•	•	•	•	•	•	Folders / 2000 val Long range / HID USB HID			
138028007	28	13,8-14,2	0,551"			±12	•	•	•	•	•	•	•	•	•				•
138024007	24	14,7-15,1	0,587"			±12	•	•	•	•	•	•	•	•	•				•
138020007	20	15,7-16,1	0,626"			±12	•	•	•	•	•	•	•	•	•				•
138016007	16	16,8-17,2	0,669"			±12	•	•	•	•	•	•	•	•	•				•
138012007	12	18,2-18,6	0,724"			±12	•	•	•	•	•	•	•	•	•				•
138010007	10	19,7-20,1	0,775"			±12	•	•	•	•	•	•	•	•	•				•
138004007	4	26,2-26,6	1,039"			±12	•	•	•	•	•	•	•	•	•				•

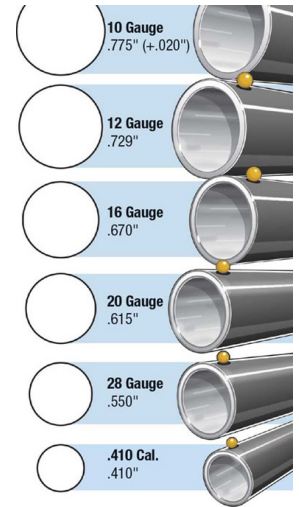

**OPTIONAL ACCESSORIES**

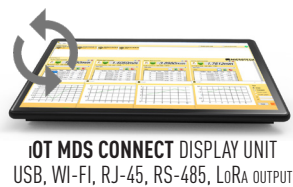

**DOWNLOAD APP**



- Two-point Big barrel bore gauges for different calibers with depth up to 3m
- Carbide tipped measuring pins
- Can be supplied with Lunets set
- Computerized **MICS** indication system
- **4 MODES DATA TRANSFER:** WIRELESS to MDS app (Windows, Android, iOS, MacOS); WIRELESS HID, WIRELESS HID+MAC, USB HID
- Calibration certificate included (ISO17025 (Ilac MRA))



LUNETS SET

Item No	Range		Reso- lution	Max Depth	Lunet set	Depth scale	Preset	Go/NoGo	Max/Min	Formula	Timer	Temp comp	Linear corr	Calibr date	Recharge	Memory	WIRELESS	USB			
	Caliber	mm																			
138006007	60	59,3-60,7	0,0001	1200	option	50	•	•	•	•	•	•	•	•	•	•	•	•			
138008007	80	79,3-80,7					•	•	•	•	•	•	•	•	•	•	•	•	•	•	•
138008107	81	80,3-81,7					•	•	•	•	•	•	•	•	•	•	•	•	•	•	•
138008207	82	81,3-82,7		•	•	•	•	•	•	•	•	•	•	•	•	•	•	•			
138012007	120	119,3-120,7		2000	3	200	•	•	•	•	•	•	•	•	•	•	•	•			
138012207	122.4	122-123,6		3000	4	200	•	•	•	•	•	•	•	•	•	•	•	•			

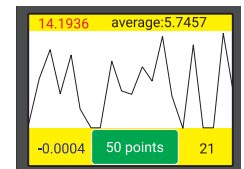

ON-LINE GRAPHIC MODE

## OPTIONAL ACCESSORIES

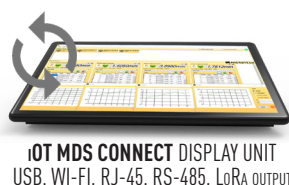

## DOWNLOAD APP



- Radius gauges for **External & Internal** measurements with range up to **15m**
- **Functions:** On-line Graphic, Analog scale, Go/NoGo, Max/Min, Formula, Timer, Linear correction, Temperature correction
- **Measuring HUB:** Wireless MICROTECH instrument connection, Synchronization, 2D mode, 2D Graph, Probe mode, Compensation
- **Memory manager:** 2000 values, Folders system, Statistics mode, **4 MODES DATA TRANSFER:** WIRELESS to MDS app (Windows, Android, iOS, MacOS); WIRELESS HID, WIRELESS HID+MAC, USB HID
- Calibration certificate included (ISO17025 (Ilac MRA))

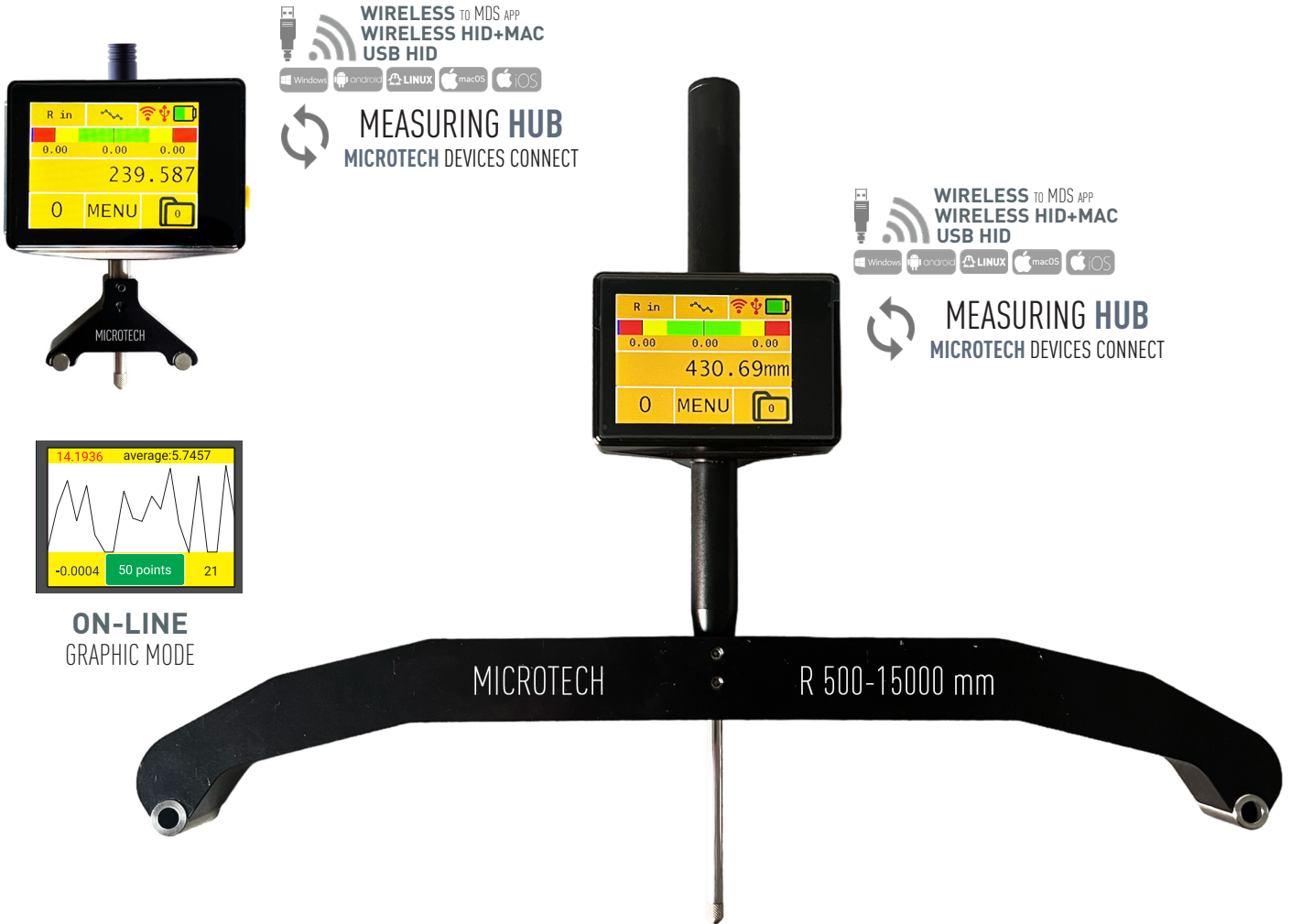

Item No	Radius		Type	Resol. µm	Accu- racy %	Base mm	Indica- tor range mm	Measuring HUB	Graphic	Analog scale	Preset	Go/NoGo	Max/Min	Formula	Timer	Temp comp	Linear corr	Calibr date				
	Range																					
	mm	inch																				
1250511017	5-60	0,2-1,2"	internal & external	1	0,4-1	10	13	•	•	•	•	•	•	•	•	•	•	•	•			
1250511007	40-1200	2-48"				40		•	•	•	•	•	•	•	•	•	•	•	•	•	•	•
1250511117	250-7500	10-300"				200		•	•	•	•	•	•	•	•	•	•	•	•	•	•	•
1250511127	500-15000	20-600"				300		•	•	•	•	•	•	•	•	•	•	•	•	•	•	•

OPTIONAL ACCESSORIES

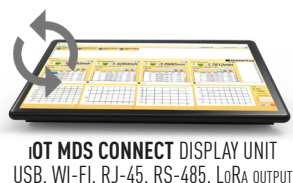

DOWNLOAD APP





- Radius gauges SET for **External & Internal** measurements
- Including Interchangeable bases set
- Functions: On-line Graphic, Analog scale, Go/NoGo, Max/Min, Formula, Timer, Linear correction, Temperature correction
- Measuring HUB: Wireless MICROTECH instrument connection, Synchronization, 2D mode, 2D Graph, Probe mode, Compensation
- Memory manager: 2000 values, Folders system, Statistics mode, **4 MODES DATA TRANSFER: WIRELESS** to MDS app (Windows, Android, iOS, MacOS); **WIRELESS HID, WIRELESS HID+MAC, USB HID**
- Calibration certificate included (ISO17025 (Ilac MRA))



**WIRELESS TO MDS APP**  
**WIRELESS HID+MAC**  
**USB HID**

**MEASURING HUB**  
 MICROTECH DEVICES CONNECT

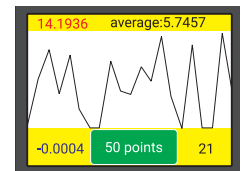

**ON-LINE GRAPHIC MODE**

Item No	Radius		Type	Resol. µm	Accu- racy %	Base mm	Indica- tor range mm	Measuring HUB	Graphic	Analog scale	Preset	Go/NoGo	Max/Min	Formula	Timer	Temp comp	Linear corr	Memory	WIRELESS	USB				
	Range																							
	mm	inch																						
1250512007	5-2000	0,2-80"	internal & external	1	0,4-1	10,30,60,100	13	•	•	•	•	•	•	•	•	•	•	•	•	•	•			
1250513007	5-4000	0,2-160"				10,30,60,100,200		•	•	•	•	•	•	•	•	•	•	•	•	•	•	•	•	•
1250515007	40-7500	2-300"				40, 200	50	•	•	•	•	•	•	•	•	•	•	•	•	•	•	•	•	•
1250516007	40-15000	2-600"				40, 300		•	•	•	•	•	•	•	•	•	•	•	•	•	•	•	•	•
1250517007	5-15000	0,2-600"				10, 40, 300		•	•	•	•	•	•	•	•	•	•	•	•	•	•	•	•	•

## OPTIONAL ACCESSORIES

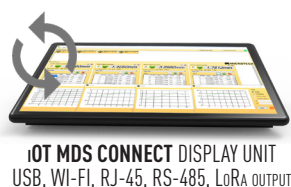

## DOWNLOAD APP



- Sphere radius gauges for external & internal measurements
- **Functions:** On-line Graphic, Analog scale, Go/NoGo, Max/Min, Formula, Timer, Linear correction, Temperature correction
- **Measuring HUB:** Wireless MICROTECH instrument connection, Synchronization, 2D mode, 2D Graph, Probe mode, Compensation
- **Memory manager:** 2000 values, Folders system, Statistics mode, **4 MODES DATA TRANSFER:** WIRELESS to MDS app (Windows, Android, iOS, MacOS); WIRELESS HID, WIRELESS HID+MAC, USB HID
- Calibration certificate included (ISO17025 (Ilac MRA))



WIRELESS TO MDS APP  
WIRELESS HID+MAC  
USB HID

MEASURING HUB  
MICROTECH DEVICES CONNECT

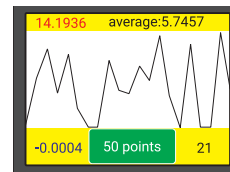

**ON-LINE GRAPHIC MODE**

Item No	Radius		Type	Resol.	Accu- racy	Measuring HUB	Graphic	Analog scale	Preset	Go/NoGo	Max/Min	Formula	Timer	Temp comp	Linear corr	Calibr date	FW update	Memory	WIRELESS	USB	
	Range																				
	mm	inch																			
1250711206	320-1250	13-30"	sphere	1	1	•	•	•	•	•	•	•	•	•	•	•	•	•	•	•	•

**OPTIONAL ACCESSORIES**

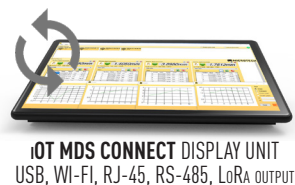
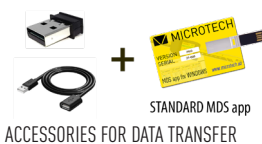

DOWNLOAD APP



- **WIDE RANGE** Radius gauges for external measurements up to 32m
- **Functions:** On-line Graphic, Analog scale, Go/NoGo, Max/Min, Formula, Timer, Linear correction, Temperature correction
- **Measuring HUB:** Wireless MICROTECH instrument connection, Synchronization, 2D mode, 2D Graph, Probe mode, Compensation
- **Memory manager:** 2000 values, Folders system, Statistics mode, **4 MODES DATA TRANSFER:** WIRELESS to MDS app (Windows, Android, iOS, MacOS); WIRELESS HID, WIRELESS HID+MAC, USB HID
- **Calibration** certificate included (ISO17025 (Ilac MRA))



PAT.UA132139  
PAT.UA10184772

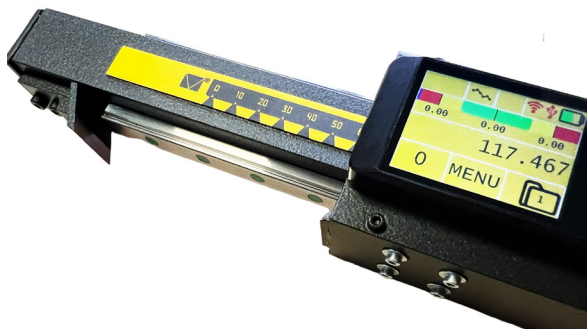

WIRELESS TO MDS APP  
WIRELESS HID+MAC  
USB HID



MEASURING HUB  
MICROTECH DEVICES CONNECT

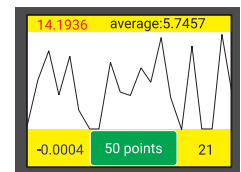

ON-LINE  
GRAPHIC MODE

Item No	Radius		Type	Reso- lution µm	Base length mm	Accuracy %	Measuring HUB	Graphic	Analog scale	Preset	Go/NoGo	Max/Min	Formula	Timer	Temp comp	Linear corr	Calibr date	FW update	Recharge	Memory	WIRELESS	USB			
	Range																								
	mm	inch																							
1250530256	60-2550	2.5-100"	external	1	600	0,1%	•	•	•	•	•	•	•	•	•	•	•	•	•	•	•	•	•		
1250531156	100-11200	4-450"			1200		•	•	•	•	•	•	•	•	•	•	•	•	•	•	•	•	•	•	•
1250533356	200-32200	8-1290"			2000		•	•	•	•	•	•	•	•	•	•	•	•	•	•	•	•	•	•	•

## OPTIONAL ACCESSORIES

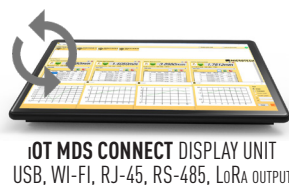

## DOWNLOAD APP



- Digital protractor 0-360° with 0.005° resolution and fine adjustment
- Bases 150 and 300mm
- **Calibration** certificate included (ISO17025 (Ilac MRA))

Item No	Range		Resolution		Accuracy		Fine adj.	Base
	grad	sec of arc	grad	rad	min of arc	wheel	mm	
151136051	0-360°	1/6' (10")	0.005°	-	±4'	•	150, 300	



**COMPUTERIZED** PROTRACTOR

- Computerized Protractor 0-360° with **MICS** indication system and fine adjustment
- Bases 150 and 300mm
- **Long range** Wireless, Wireless HID or USB HID data transfer to Windows, Android, iOS, macOS, Linux systems direct to any app.
- **Calibration** certificate included (ISO17025 (Ilac MRA))



Item No	Range		Resolution		Accuracy		Fine adj.	Base	Preset	Go/NoGo	Max/Min	Formula	Timer	Temp comp	Linear corr	Calibr date	Recharge	Memory	WIRELESS	USB
	grad	sec of arc	grad	rad	min of arc	wheel	mm													
151136055	0-360°	1/12' (5")	0.005°	0.0001	±3'	•	150, 300	•	•	•	•	•	•	•	•	•	•	•	•	•

**OPTIONAL ACCESSORIES**

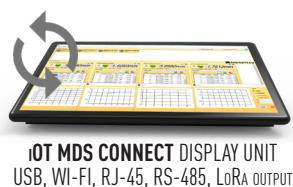

**DOWNLOAD APP**



- Industry 4.0 adopted precision level with computerized MICS system with 2,4" color Touchscreen
- Functions: On-line Graphic, Analog scale, Go/NoGo, Max/Min, Formula, Timer, Linear correction
- Measuring HUB: Wireless MICROTECH instrument connection, Synchronization, 2D mode, 2D Graph
- Memory manager: 2000 values, Folders system, Statistics mode, Memory data transfer
- **4 MODES DATA TRANSFER:** WIRELESS to MDS app (Windows, Android, iOS, MacOS); WIRELESS HID, WIRELESS HID+MAC, USB HID
- Calibration certificate included (ISO17025 (Ilac MRA))



**MEASURING HUB**  
MICROTECH DEVICES CONNECT



WIRELESS TO MDS APP  
WIRELESS HID+MAC  
USB HID

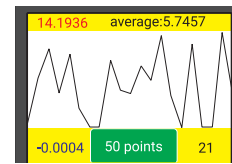
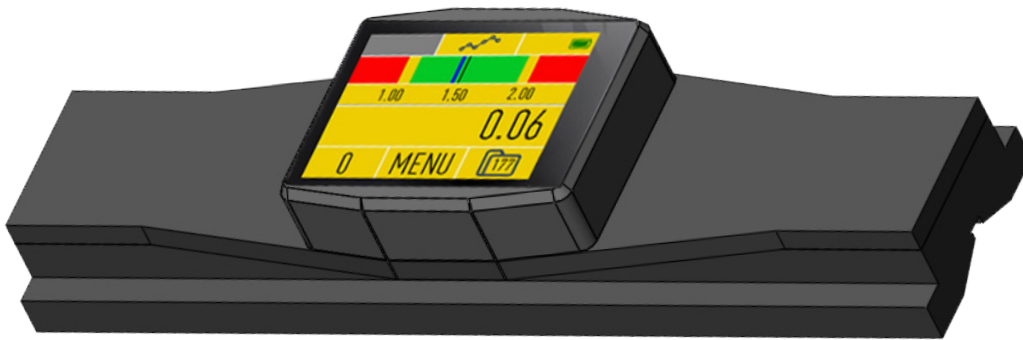

**ON-LINE**  
GRAPHIC MODE

Item No	Axis	Base		Range		Resolution		Flat-ness	Measuring HUB	Graphic	Analog scale	Preset	Go/NoGo	Max/Min	Formula	Timer	Temp comp	Linear corr	Calibr date	Recharge	Memory	WIRELESS	USB	
		Size	material	mm/m	grad	mm/m	grad																	mm/m
		mm																						
152110020	2	200	steel	± 1	±45,00°	0.05	0.005°	0.005	•	•	•	•	•	•	•	•	•	•	•	•	•	•	•	•
152110030		300							•	•	•	•	•	•	•	•	•	•	•	•	•	•	•	•

### OPTIONAL ACCESSORIES

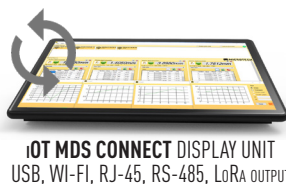

### DOWNLOAD APP



- 2D Macro-Profile computerized stand
- CONTACT (sub-micron indicator)
- Different ranges and modifications for customers request
- Computerized **MICS** indication system Modification with **Long range** Wireless, Wireless HID or USB HID data transfer to Windows, Android, iOS, macOS, Linux systems direct to any app.
- **Calibration** certificate included (ISO17025 (Ilac MRA))



**MEASURING HUB**  
MICROTECH DEVICES CONNECT

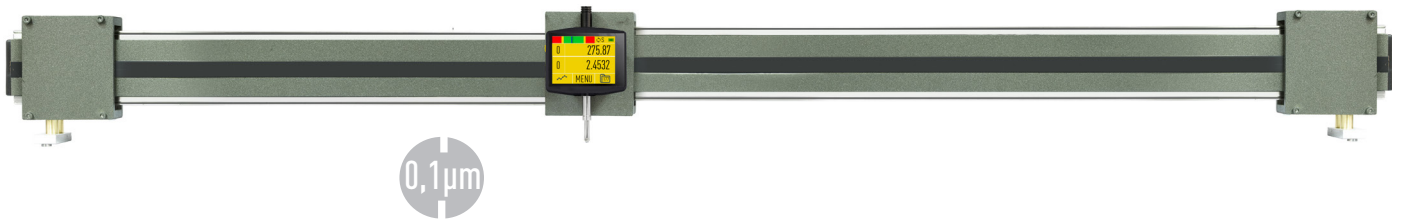

**CUSTOM RANGE FOR REQUEST**

Item No	Axis	Range		Resolution		Accuracy		Weight	Preset	Go/NoGo	Max/Min	Formula	Timer	Temp comp	Linear corr	Calibr date	Recharge	Memory	WIRELESS	USB
		X	Z	X	Z	X	Z													
		mm	mm	mm	mm	mm	mm													
27720902	1D	0-900	0-12		0.0001			7.0	•	•	•	•	•	•	•	•	•	Folders / 2000 val	Long range / HID	USB HID / Update
27720900	2D			0,01			±0,030	±0,002	7.2	•	•	•	•	•	•	•	•			
27721802	1D	0-1800	0-12						11.5	•	•	•	•	•	•	•	•			
27721800	2D			0,01			±0,060		11.7	•	•	•	•	•	•	•	•			
27722802	1D	0-2800	0-25					±0,004	20.5	•	•	•	•	•	•	•	•			
27722800	2D			0,01			±0,100		20.7	•	•	•	•	•	•	•	•			
27723802	1D	0-3800	0-50					±0,006	24.5	•	•	•	•	•	•	•	•			
27723800	2D			0,01			±0,160		25	•	•	•	•	•	•	•	•			

**OPTIONAL ACCESSORIES**

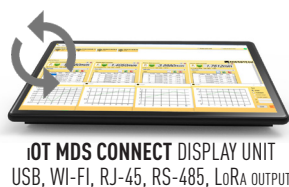

**DOWNLOAD APP**



# 2D LASER MACRO-PROFILE COMPUTERIZED STAND

- 2D Macro-Profile computerized stand
- NON-CONTACT (laser) modifications
- Different ranges and modifications for customers request
- Computerized **MICS** indication system Modification with **Long range** Wireless, Wireless HID or USB HID data transfer to Windows, Android, iOS, macOS, Linux systems direct to any app.
- **Calibration** certificate included (ISO17025 (Ilac MRA))



**MEASURING HUB**  
MICROTECH DEVICES CONNECT



WIRELESS TO MDS APP  
WIRELESS HID+MAC  
USB HID



**CUSTOM RANGE FOR REQUEST**



NON CONTACT Z-AXIS RED LASER

Item No	Axis	Range		Resolution		Accuracy		Weight	Preset	Go/NoGo	Max/Min	Formula	Timer	Temp comp	Linear corr	Calibr date	Recharge	Memory	WIRELESS	USB	
		X	Z	X	Z	X	Z														
		mm	mm	mm	mm	mm	mm														
27720907	2D	0-900	0-8	0,01	0.002	±0,030		7.0	•	•	•	•	•	•	•	•	•	•	•	•	•
27720908	2D		0-40		0,01																
27721807	2D	0-1800	0-8		0.002	±0,060		11.5	•	•	•	•	•	•	•	•	•	•	•	•	•
27721808	2D		0-40		0,01																
27722807	2D	0-2800	0-8		0.002	±0,100		20.5	•	•	•	•	•	•	•	•	•	•	•	•	•
27722808	2D		0-40		0,01																
27723807	2D	0-3800	0-8		0.002	±0,160		24.5	•	•	•	•	•	•	•	•	•	•	•	•	•
27723808	2D		0-40		0,01																

## OPTIONAL ACCESSORIES

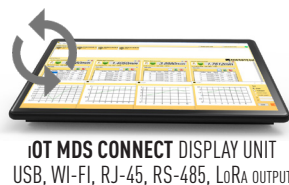

## DOWNLOAD APP



- Pipe straightness control stand
- Different ranges and modifications for customers request
- Computerized **MICS** indication system Modification with Long range Wireless, Wireless HID or USB HID data transfer to Windows, Android, iOS, macOS, Linux systems direct to any app.
- **Calibration** certificate included (ISO17025 (Ilac MRA))

WIRELESS TO MDS APP  
WIRELESS HID+MAC  
USB HID

Windows Android LINUX macOS iOS



**CUSTOM RANGE FOR REQUEST**



PAT.UA521681  
PAT.UA140992

Item No	Axis	Range		Resolution	Accuracy		Weight	Preset	Go/NoGo	Max/Min	Formula	Timer	Temp comp	Linear corr	Calibr date	Recharge	Memory	WIRELESS	USB	
		X	Z		X	Z														
		mm	mm		mm	mm														
27520900	2D	0-900	0-12	0,0001	±0,040	±0,002	10	•	•	•	•	•	•	•	•	•	•	•	•	•
27521800		0-1800			±0,080	±0,002	15	•	•	•	•	•	•	•	•	•	•	•	•	•
27522800		0-2800			±0,120	±0,002	35	•	•	•	•	•	•	•	•	•	•	•	•	•

**OPTIONAL ACCESSORIES**

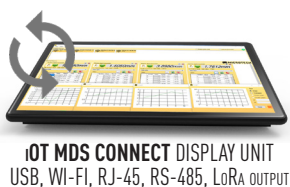

DOWNLOAD APP



MADE IN UKRAINE



# BOTTLE FORM CONTROL STAND

- Bottle form control stand
- Different modifications for customers request
- Computerized **MICS** indication system Modification with Long range Wireless, Wireless HID or USB HID data transfer to Windows, Android, iOS, macOS, Linux systems direct to any app.
- Calibration certificate included (ISO17025 (Ilac MRA))



WIRELESS TO MDS APP  
WIRELESS HID+MAC  
USB HID

Windows Android LINUX macOS iOS

0,1 μm

- 1 - Parallelism
- 2 - Height
- 3 - Perpendicularity

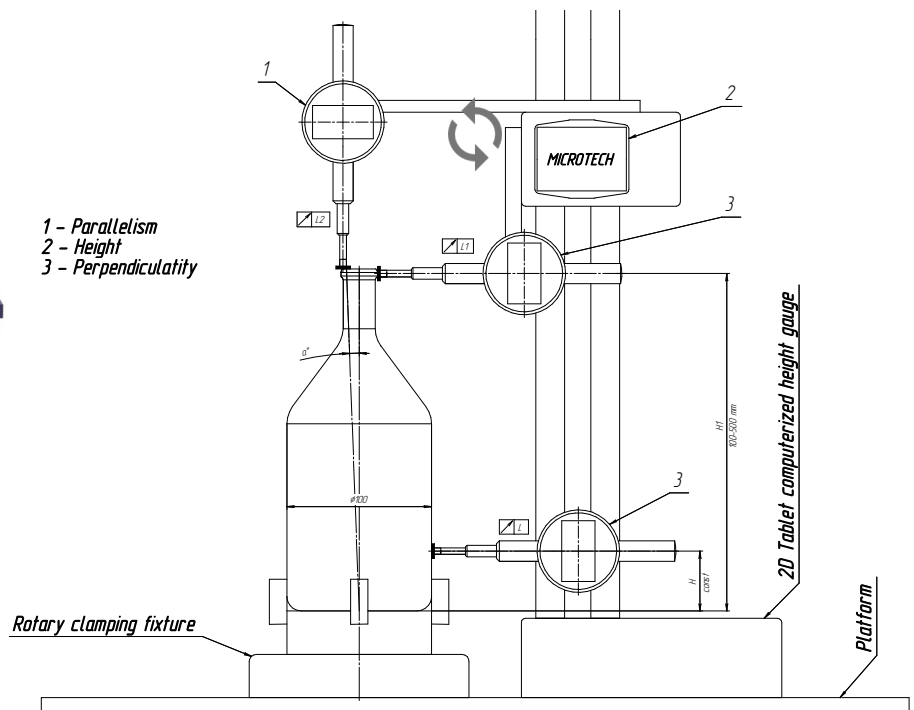

CUSTOM RANGE FOR REQUEST

Item No	Range	Max bottle height	Resolution	Accuracy	Rotary fixture	Quick clamp	Parallelism	Perpendicularity	Height	Measuring & protocol	Data output
	mm	mm									
254910000	20-100	310	0,0001	±0,040	•	•	•	•			WIRELESS
254920000	50-200	500		±0,025	•	•	•	•	•	auto/ 1 install	

## OPTIONAL ACCESSORIES

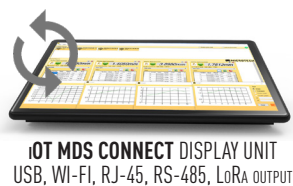

## DOWNLOAD APP



MADE IN UKRAINE

- Bearing control stand KIA, SIA, KEA
- Completing with 3pcs indicators (Computerized or Digital), 3 magnetic stands, set of Weights for internal & external bearing control
- Digital or Computerized **MICS** indication system Modification with Long range Wireless, Wireless HID or USB HID data transfer to Windows, Android, iOS, macOS, Linux systems direct to any app.
- **Calibration** certificate included (ISO17025 (Ilac MRA))



total.com.ua

**CUSTOM RANGE FOR REQUEST**

Item No	Range		Reso- lution	Repea- tability	Weights		Preset	Go/NoGo	Max/Min	Formula	Timer	Temp comp	Linear corr	Calibr date	Recharge	Memory	WIRELESS	USB	
	internal	external			internal	external													
	SIA KIA	KEA			SIA KIA	KEA													
255500001			0,001	0,005	10-40N	12-40N	•												•
255500007	20-200	10-140	0,0001		22pcs	23pcs	•	•	•	•	•	•	•	•	•	•	•	•	•

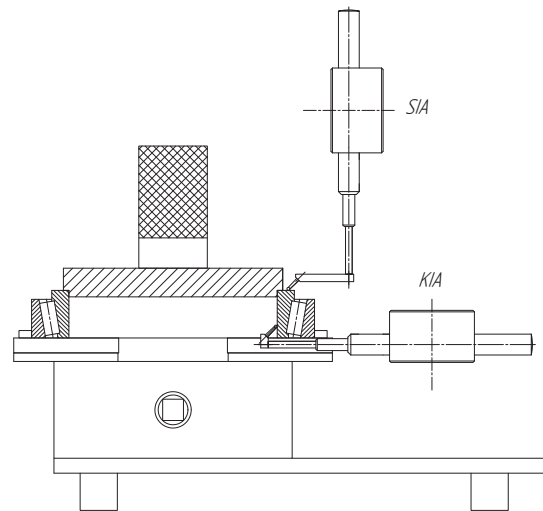
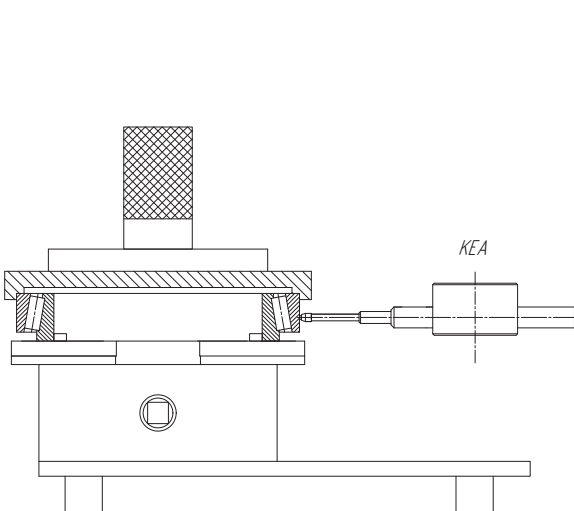

- Wheel rims runout measuring stand for wheels diameter 15-24"
- Completing with 4pcs indicators (Computerized or Digital)
- Digital or Computerized **MICS** indication system Modification with **Long range Wireless**, **Wireless HID** or **USB HID** data transfer to Windows, Android, iOS, macOS, Linux systems direct to any app.
- **Calibration** certificate included (ISO17025 (Ilac MRA))



**CUSTOM RANGE FOR REQUEST**

Item No	Disk D	Height rims	Resolution	Accuracy	Quick clamp	Indication		Go/NoGo	Max/Min	Memory	Data output
	inch	mm				mm	mm				
255913241	15-24	20-35	0,001	±0,100	•	Digital	4pcs	•			
255913247			0,0001	±0,050	•	Computerized	4pcs	•	•	•	WIRELESS +USB

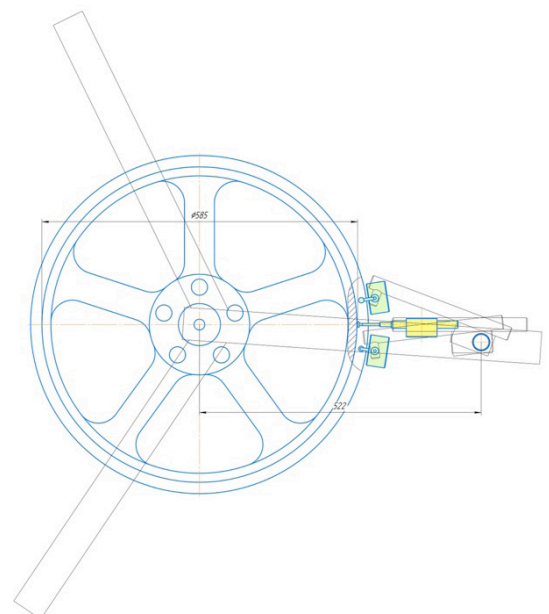
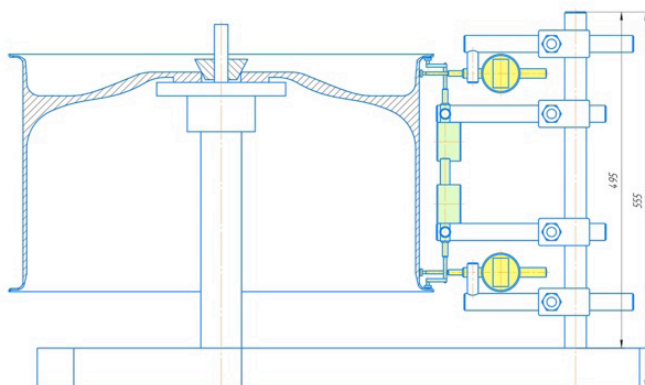

- Calibration stands for ruler calibration
- High resolution 7" LED microscope
- Patents UA147069, UA151330
- **Functions:** On-line Graphic, Analog scale, Go/NoGo, Max/Min, Formula, Timer, Linear correction, Temperature correction
- **Measuring HUB:** Wireless MICROTECH instrument connection, 2D mode,
- **Memory manager:** 2000 values, Folders system, Statistics mode,
- **4 MODES DATA TRANSFER:** WIRELESS to MDS app (Windows, Android, iOS, MacOS); WIRELESS HID, WIRELESS HID+MAC, USB HID
- Calibration certificate included (ISO17025 (Iac MRA))

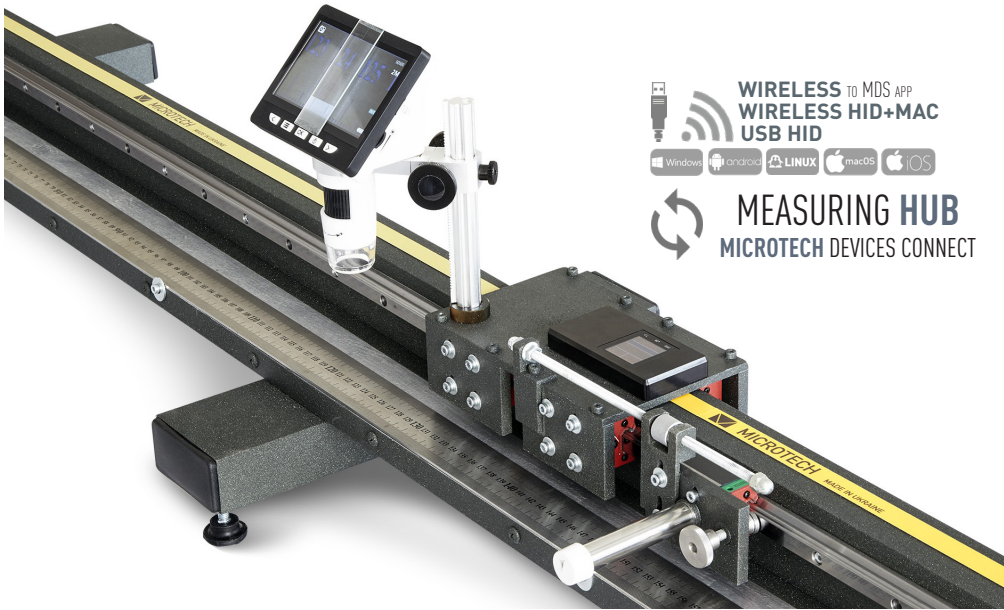

WIRELESS TO MDS APP  
WIRELESS HID+MAC  
USB HID

Windows Android LINUX macOS iOS

MEASURING HUB  
MICROTECH DEVICES CONNECT

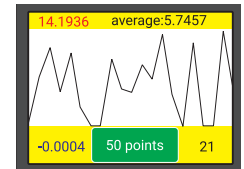

**ON-LINE GRAPHIC MODE**

**CUSTOM RANGE FOR REQUEST**



Item No	Range		Reso- lution	Accu- racy	Micro- scope	Mag- netic fixator	Preset	Go/NoGo	Max/Min	Formula	Timer	Temp comp	Linear corr	Calibr date	Recharge	Memory	WIRELESS	USB
	mm	inch																
258010003	0-1000	0-40"	0,01	±0,010+L/65	LED 7 inch	+	•	•	•	•	•	•	•	•	•	Folders / 2000 val	Long range / HID	WIRELESS USB HID / Update
258020003	0-2000	0-80"		±0,015+L/50		+	•	•	•	•	•	•	•	•	•			
258030003	0-3000	0-120"		±0,020+L/40		+	•	•	•	•	•	•	•	•	•			

**OPTIONAL ACCESSORIES**

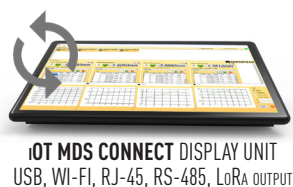

**DOWNLOAD APP**



- Calibration stands for ruler & tape calibration
- High resolution 7" LED microscope
- Patents UA147069, UA151330
- Functions: On-line Graphic, Analog scale, Go/NoGo, Max/Min, Formula, Timer, Linear correction, Temperature correction
- Measuring HUB: Wireless MICROTECH instrument connection, 2D mode,
- Memory manager: 2000 values, Folders system, Statistics mode,
- **4 MODES DATA TRANSFER:** WIRELESS to MDS app (Windows, Android, iOS, MacOS); WIRELESS HID, WIRELESS HID+MAC, USB HID
- Calibration certificate included (ISO17025 (Iac MRA))



WIRELESS TO MDS APP  
WIRELESS HID+MAC  
USB HID



MEASURING HUB  
MICROTECH DEVICES CONNECT

TAPE DRUM

FORCE GAUGE FOR TENSILE LOAD 50N

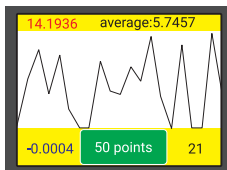

ON-LINE  
GRAPHIC MODE

CUSTOM RANGE FOR REQUEST



Item No	Range		Reso- lution	Accu- racy	Micro- scope	Mag- netic fixator	Force gauge	Tape drum	Preset	Go/NoGo	Max/Min	Formula	Timer	Temp comp	Linear corr	Calibr date	Recharge	Memory	WIRELESS	USB																
	mm	inch																			mm	mm														
258010005	0-1000	0-40"	0,01	±0,010+L/65	LED 7 inch	+	Digital 50N	+	•	•	•	•	•	•	•	•	•	Folders / 2000 val	Long range / HID	USB HID / Update																
258020005	0-2000	0-80"		±0,015+L/50																	+	•	•	•	•	•	•	•	•	•	•	•	•	•	•	•
258030005	0-3000	0-120"		±0,020+L/40																	+	•	•	•	•	•	•	•	•	•	•	•	•	•	•	•

## OPTIONAL ACCESSORIES

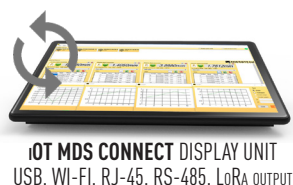

## DOWNLOAD APP



- Manual Horizontal calibration stands for dial and digital indicators with 0.01mm resolution
- **Functions:** Go/NoGo, Max/Min, Formula, Timer, Linear correction, Temperature correction, Resolution selecting,
- **Memory manager:** 2000 values, Folders system, Statistics mode, Memory data transfer
- **4 MODES DATA TRANSFER:** WIRELESS to MDS APP (Windows, Android, iOS, MacOS); WIRELESS HID, WIRELESS HID+MAC, USB HID
- Calibration certificate included (ISO17025 (Ilac MRA))

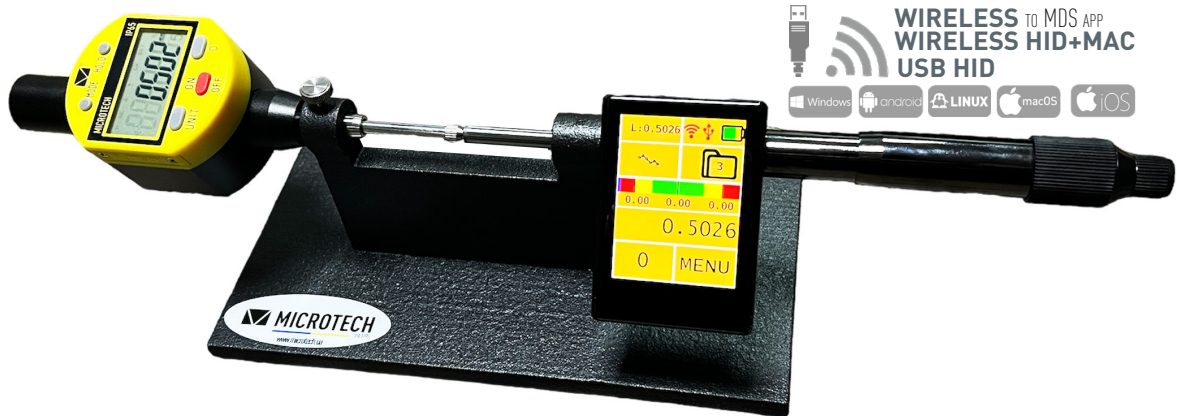

Item No	Calibrated devices	Range		Resol	Micrometer head		Non-Rotating	Preset	Go/NoGo	Max/Min	Formula	Timer	Temp comp	Linear corr	Calibr date	FW update	Recharge	Memory	WIRELESS	USB	
		mm	inch		Range	Accur.															
		mm	mm		µm																
25111026	indicators	0-25	0-1"	0,0001	25	±2	•	•	•	•	•	•	•	•	•	•	•	•	•	•	•
25111027	0.01mm						•	•	•	•	•	•	•	•	•	•	•	•	•	•	•
25111051	resolution	0-50	0-2"		50	±3	•	•	•	•	•	•	•	•	•	•	•	•	•	•	•

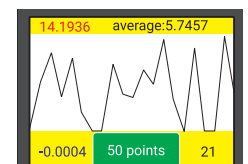

ON-LINE GRAPHIC MODE

## OPTIONAL ACCESSORIES

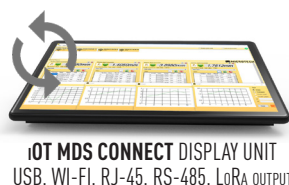

## DOWNLOAD APP



- Manual Vertical calibration stands for dial, digital and lever indicators with 0.01mm resolution
- **Functions:** Go/NoGo, Max/Min, Formula, Timer, Linear correction, Temperature correction, Resolution selecting,
- **Memory manager:** 2000 values, Folders system, Statistics mode, Memory data transfer
- **4 MODES DATA TRANSFER:** WIRELESS to MDS app (Windows, Android, iOS, MacOS); WIRELESS HID, WIRELESS HID+MAC, USB HID
- Calibration certificate included (ISO17025 (Ilac MRA))

INSTALLATION MICROMETER HEAD IN 2 POSITIONS



0,1µm



FOR DIAL & DIGITAL INDICATORS  
0.01MM RESOLUTION  
RANGE UP TO 50MM



ACCORDING DIN 2270 FOR  
LEVER INDICATORS

Item No	Range		Resol	Micrometer head															
				Range	Accur.	Non-Rotating	Preset	Go/NoGo	Max/Min	Formula	Timer	Temp comp	Linear corr	Calibr date	FW update	Recharge	Memory	WIRELESS	USB
	mm	inch		mm	µm														
25113025	0-25	0-1"	0,0001	25	±2		•	•	•	•	•	•	•	•	•	•	•	•	•
25113027					±2	•	•	•	•	•	•	•	•	•	•	•	•	•	•
25113050	0-50	0-2"		50	±2	•	•	•	•	•	•	•	•	•	•	•	•	•	•

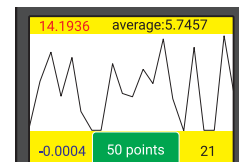

ON-LINE  
GRAPHIC MODE

## OPTIONAL ACCESSORIES

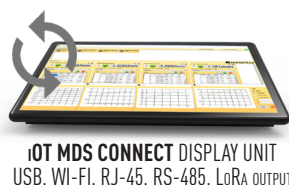

## DOWNLOAD APP



MADE IN UKRAINE

- Manual Universal calibration stands for dial, digital indicators with 0.01mm resolution and bore gauges
- **Functions:** Go/NoGo, Max/Min, Formula, Timer, Linear correction, Temperature correction, Resolution selecting,
- **Memory manager:** 2000 values, Folders system, Statistics mode, Memory data transfer
- **4 MODES DATA TRANSFER:** WIRELESS to MDS app (Windows, Android, iOS, MacOS); WIRELESS HID, WIRELESS HID+MAC, USB HID
- **Calibration certificate** included (ISO17025 (Ilac MRA))



WIRELESS TO MDS APP  
WIRELESS HID+MAC  
USB HID

Windows Android LINUX macOS iOS

0,1µm

Item No	Calibrated devices	Range		Resol	Micrometer head		Non-Rotating	Preset	Go/NoGo	Max/Min	Formula	Timer	Temp comp	Linear corr	Calibr date	FW update	Recharge	Memory	WIRELESS	USB			
					Range	Accur.																	
		mm	inch	mm	mm	µm																	
25111300	Indicators & Bore gauges	0-300	0-12"	0,0001	25	±2		•	•	•	•	•	•	•	•	•	•	•	•	•	•		
25111500		0-500	0-20"					•	•	•	•	•	•	•	•	•	•	•	•	•	•	•	•
25111900		0-1000	0-40"					•	•	•	•	•	•	•	•	•	•	•	•	•	•	•	•

**OPTIONAL ACCESSORIES**

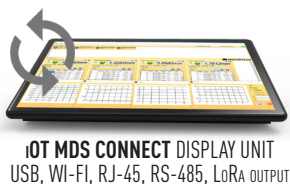

DOWNLOAD APP





# SHORE DUROMETER

- Tablet SHORE durometer for different scales (A, C, D, F, 00)
- **Functions:** Go/NoGo, Max/Min, Formula, Timer, Linear correction, Resolution selecting
- **Memory manager:** 2000 values, Folders system, Statistics mode, Memory data transfer
- **4 MODES DATA TRANSFER:** WIRELESS to MDS app (Windows, Android, iOS, MacOS); WIRELESS HID, WIRELESS HID+MAC, USB HID
- Calibration certificate included (ISO17025 (Ilac MRA))



Item No	Shore Scale	Range unit	Resol unit	Indenter			Force N	Preset	Go/NoGo	Max/Min	Formula	Timer	Temp comp	Linear corr	Calibr date	FW update	Recharge	Memory	WIRELESS	USB
				Diameter mm	Indenting foot	Extension mm														
21100101	A	0-100	0,01	1,40	35° truncated cone D=0,79mm	2,54	8,05	•	•	•	•	•	•	•	•	•	•	Folders / 2000 val	Long range / HID	USB HID / Update
21100102	C				30° cone R=0,1mm		44,45	•	•	•	•	•	•	•	•	•				
21100103	D			1,20 mm spherical R	1,111		•	•	•	•	•	•	•	•	•					
21100104	00																			
21100105	F								0,55-4.3	•	•	•	•	•	•	•	•			

# MULTISCALE SHORE DUROMETER



Item No	Shore Scale	Indenters pcs
21100110	A,C	2
21100111	A,D	2
21100120	A,C,D	3
21100100	A,C,D,00	4
21100130	A,C,D,00, F	5

## OPTIONAL ACCESSORIES

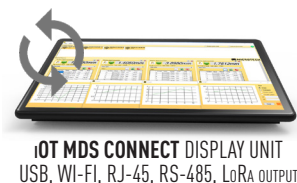

INTERCHANGEABLE INDENTERS

- Budget portable multiscale (HV, HB, HRA, HRB, HRC, HSD, MPA) hardness tester
- Calibration certificate included (ISO17025 (Ilac MRA))



**UNIVERSAL PORTABLE HARDNESS TESTER TPU-1**

<b>Item No</b>	21100001
<b>Scales</b>	HV, HB, HRA, HRB, HRC, HSD, MPA
<b>Accuracy</b>	±5 HL
<b>Internal memory</b>	500 values
<b>Rockwell Scales</b>	HRA, HRB, HRC
<b>Display</b>	160x128 TFT LCD with backlight
<b>Connection</b>	USB Type-C
<b>Power supply</b>	3xAAA battery
<b>Dimensions</b>	154mm×82mm×26 mm
<b>Weight</b>	0,25 Kg
<b>Complectation</b>	Digital display, Impact D, Calibration block, USB cable, Calibration certificate

- Industry 4.0 adopted FORCE GAUGE with computerized MICS system with 2,4" color Touchscreen
- Modification with INTERNAL & EXTERNAL force sensors (up to 1000KN)
- Functions: On-line Graphic, Analog scale, Go/NoGo, Max/Min, Formula, Timer, Linear correction
- Measuring HUB: Wireless MICROTECH instrument connection, Synchronization, 2D mode, 2D Graph
- Memory manager: 2000 values, Folders system, Statistics mode, Memory data transfer
- **4 MODES DATA TRANSFER:** WIRELESS to MDS app (Windows, Android, iOS, MacOS); WIRELESS HID, WIRELESS HID+MAC, USB HID
- Calibration certificate included (ISO17025 (Ilac MRA))

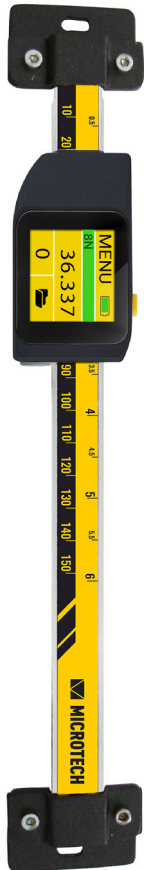

WIRELESS READING  
SCALES CONNECTION



WIRELESS TO MDS APP  
WIRELESS HID+MAC  
USB HID

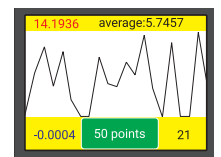

ON-LINE  
GRAPHIC MODE

Item No	Range			Reso- lution	Accu- racy	Preset	Go/NoGo	Max/Min	Formula	Timer	Temp comp	Linear corr	Calibr date	FW update	Recharge	Memory	WIRELESS	USB	Display
	N	kg	lbF																
225170017	1-10	0,1-1	0.2-2	0,001	0.3	•	•	•	•	•	•	•	•	•	•	Folders / 2000	Long range	USB HID /	Touchscreen
225170057	1-50	0,2-5	1-11,5			•	•	•	•	•	•	•	•	•	•				
225170107	2-100	0,5-10	1-22,5			•	•	•	•	•	•	•	•	•	•				
225170507	5-500	1-50	2-112			•	•	•	•	•	•	•	•	•	•				

DOWNLOAD APP



OPTIONAL ACCESSORIES

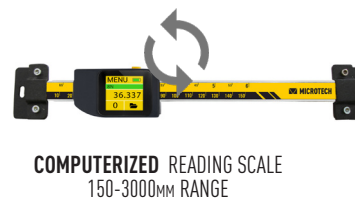
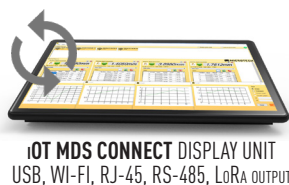



**WIRELESS READING SCALES CONNECTION**

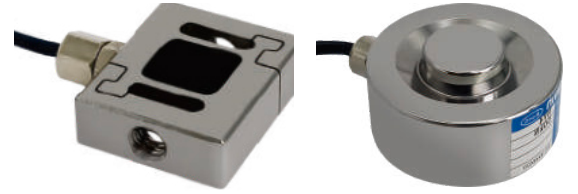

**OPTIONAL EXTERNAL FORCE SENSORS**

Item No	Accuracy	Preset	Go/NoGo	Max/Min	Formula	Timer	Temp comp	Linear corr	Calibr date	FW update	Recharge	Memory	WIRELESS	USB
	%													
225170707	0.3	•	•	•	•	•	•	•	•	•	•	•	•	•

**FORCE** SENSORS S-TYPE PUSH-PULL

Item No	Type	Force			Linearity	Hysteresis	Repeatability	Dimension	Thread holes	
		N	kg	lbF						
225110001	FSPP	Push Pull	1	0,1	0,23	0,05	0,05	0,05	16x19	2xM3
225171002			5	0,5	1,12					
225110003			10	1	2,25					
225110004			50	5	11,2					
225110005			100	10	22,5					
225110006			500	50	112	0,03	0,03	0,03	50x76	2xM12
225110007			1000	100	225					
225110008			5000	500	1120					
225110009			10000	1000	2250					
225110010			50000	5000	11200					
225110011			100000	10000	22500					



**FORCE** SENSORS ROUND-TYPE PUSH-PULL

Item No	Type	Force			Linearity	Hysteresis	Repeatability	Diameter	
		N	kg	lbF				Base	Load
								mm	mm
225120001	FOPP	Push Pull	100	10	22,5	0,1	0,1	41	36
225120002			500	50	112				
225120003			1000	100	225				
225120004			5000	500	1120				
225120005			10000	1000	2250				
225120006			20000	2000	4500				



**FORCE** SENSORS ROUND-TYPE PUSH

Item No	Type	Force			Linearity	Hysteresis	Repeatability	Diameter	
		N	kg	lbF				Base	Load
								mm	mm
225130001	FOP	Push	1000	100	225	0,2	0,1	50	13
225130002			5000	500	1120				
225130003			10000	1000	2250				
225130004			50000	5000	11200				
225130005			100000	10000	22500				



- Industry 4.0 adopted Manual FORCE tester with computerized MICS system with 2,4" color Touchscreen
- **Computerized FORCE tester included**
- Optional READING SCALE
- Functions: On-line Graphic, Analog scale, Go/NoGo, Max/Min, Formula, Timer, Linear correction
- Measuring HUB: Wireless MICROTECH instrument connection, Synchronization, 2D mode, 2D Graph
- Memory manager: 2000 values, Folders system, Statistics mode, Memory data transfer
- **4 MODES DATA TRANSFER:** WIRELESS to MDS app (Windows, Android, iOS, MacOS); WIRELESS HID, WIRELESS HID+MAC, USB HID
- Calibration certificate included (ISO17025 (Ilac MRA))

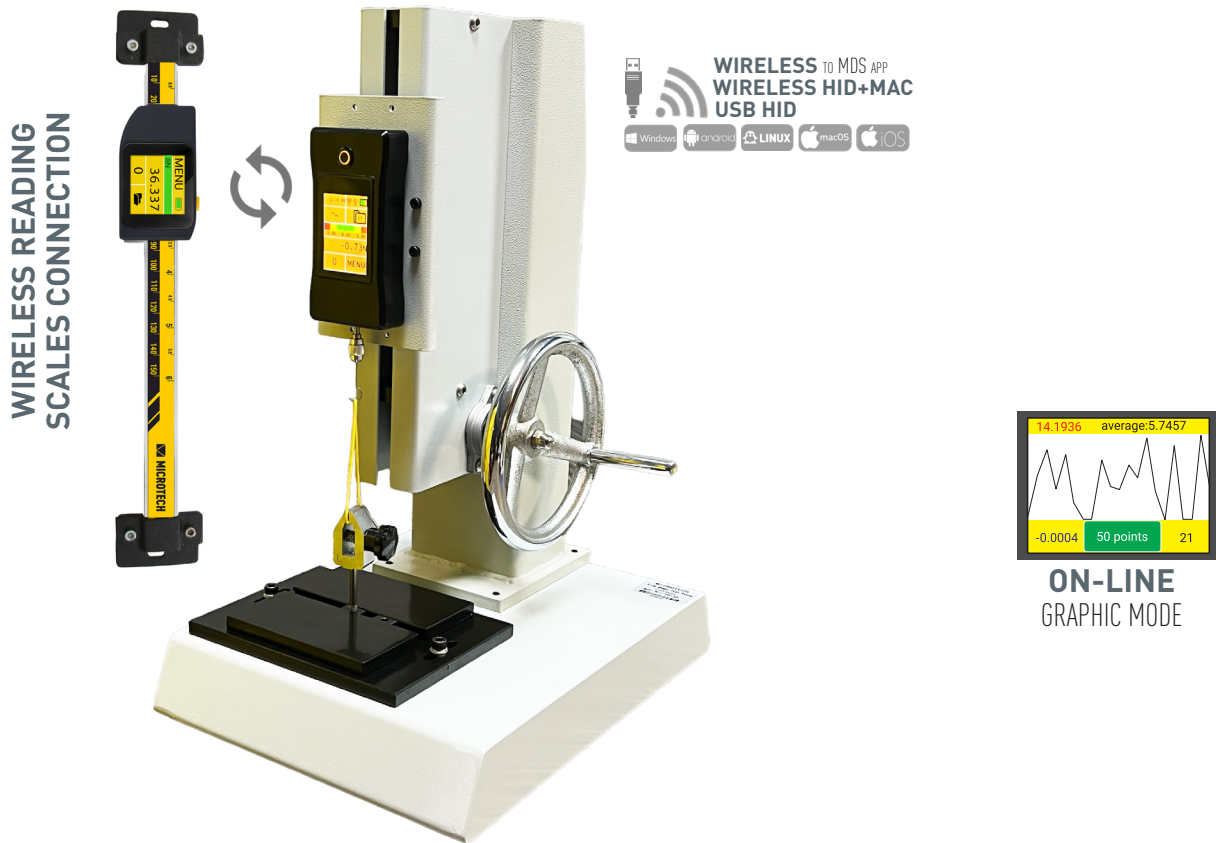

Item No	Load		Reso- lution	Range	Scale	Weight	Preset	Go/NoGo	Max/Min	Formula	Timer	Temp comp	Linear corr	Calibr date	FW update	Recharge	Memory	WIRELESS	USB				
	N	lbF																		N	mm	kg	
278170056	500	112	0,001	180	option	25	•	•	•	•	•	•	•	•	•	•	•	•	•	•			
278170106	1000	225					•	•	•	•	•	•	•	•	•	•	•	•	•	•	•	•	•
278170107							•	•	•	•	•	•	•	•	•	•	•	•	•	•	•	•	•

## OPTIONAL ACCESSORIES

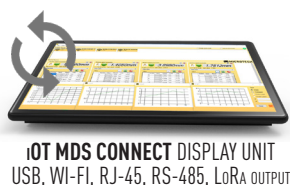

## DOWNLOAD APP



- Industry 4.0 adopted Motorized FORCE tester with computerized MICS system with 2,4" color Touchscreen
- **Computerized FORCE tester included**
- Optional READING SCALE
- Functions: On-line Graphic, Analog scale, Go/NoGo, Max/Min, Formula, Timer, Linear correction
- Measuring HUB: Wireless MICROTECH instrument connection, Synchronization, 2D mode, 2D Graph
- Memory manager: 2000 values, Folders system, Statistics mode, Memory data transfer
- **4 MODES DATA TRANSFER:** WIRELESS to MDS app (Windows, Android, iOS, MacOS); WIRELESS HID, WIRELESS HID+MAC, USB HID
- Calibration certificate included (ISO17025 (Ilac MRA))



Item No	Load		Reso- lution N	Range mm	Scale	Preset	Go/NoGo	Max/Min	Formula	Timer	Temp comp	Linear corr	Calibr date	FW update	Recharge	Memory	WIRELESS	USB
	N	lbF																
278170058	500	112	0,001	200	option	•	•	•	•	•	•	•	•	•	•	•	•	•
278170108	1000	225		700		•	•	•	•	•	•	•	•	•	•	•	•	•

**OPTIONAL ACCESSORIES**

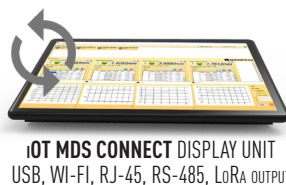

**DOWNLOAD APP**



- Industry 4.0 adopted Manual Hydraulic FORCE tester with computerized MICS system with 2,4" color Touchscreen
- **Computerized FORCE tester included**
- Optional READING SCALE
- Measuring range up to 100000N
- **Functions:** On-line Graphic, Analog scale, Go/NoGo, Max/Min, Formula, Timer, Linear correction
- **Measuring HUB:** Wireless MICROTECH instrument connection, Synchronization, 2D mode, 2D Graph
- **Memory manager:** 2000 values, Folders system, Statistics mode, Memory data transfer
- **4 MODES DATA TRANSFER:** WIRELESS to MDS app (Windows, Android, iOS, MacOS); WIRELESS HID, WIRELESS HID+MAC, USB HID
- Calibration certificate included (ISO17025 (Ilac MRA))



### CUSTOM RANGE FOR REQUEST

Item No	Load		Reso- lution	Range	Scale	Weight	Preset	Go/NoGo	Max/Min	Formula	Timer	Temp comp	Linear corr	Calibr date	FW update	Recharge	Memory	WIRELESS	USB	
	N	LbF																		N
235152007	5000	1125	1	120	option	80	•	•	•	•	•	•	•	•	•	•	•	•	•	
235152017	10000	2250				105	•	•	•	•	•	•	•	•	•	•	•	•	•	•
235152057	50000	11250		140		195	•	•	•	•	•	•	•	•	•	•	•	•	•	•
235152107	100000	22500				280	•	•	•	•	•	•	•	•	•	•	•	•	•	•

### OPTIONAL ACCESSORIES

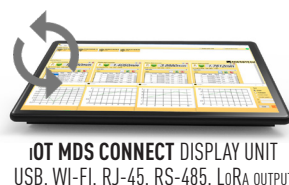

### DOWNLOAD APP





**MICROTECH**

est. 1995

U K R A I N E

Only innovative measuring  
instruments

04080, Kyiv, Ukraine  
Nizhneyurkovska str., 45a  
61001, Kharkiv, Ukraine  
str. Rustaveli, 39

[www.microtech.ua](http://www.microtech.ua)  
[tool@microtech.ua](mailto:tool@microtech.ua)

